

8600 SERIES

VIBRATING SAMPLE MAGNETOMETERS

2017
R&D
100
WINNER

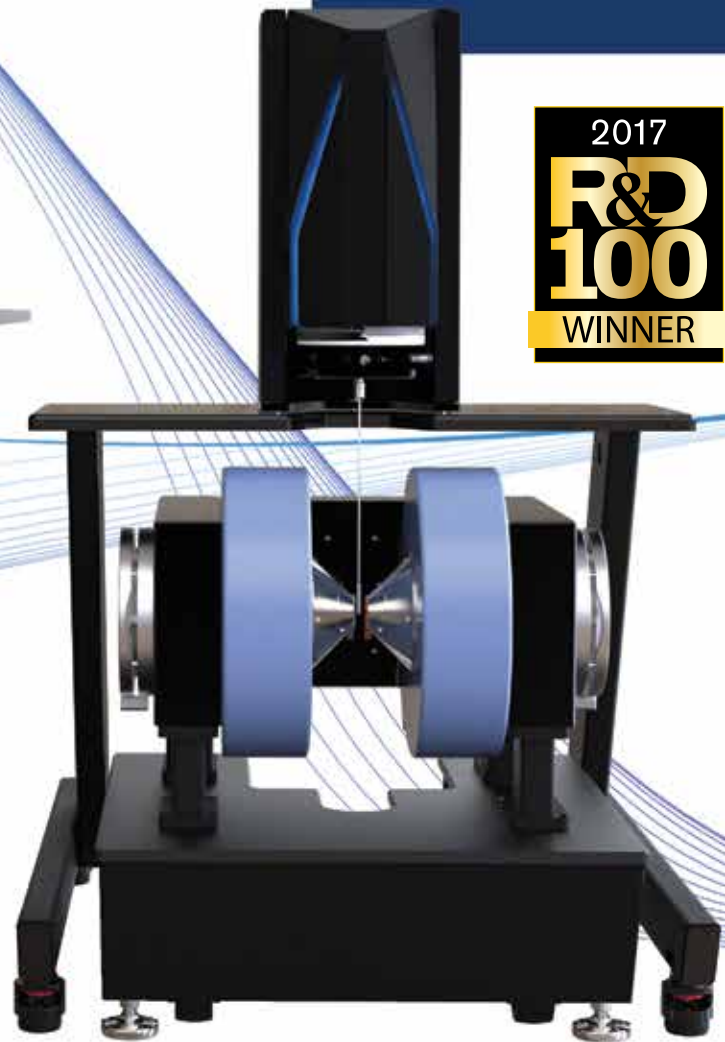
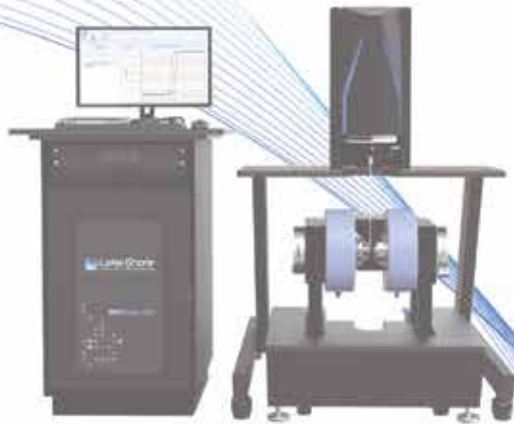

CONTENTS

MORE SCIENCE, LESS TIME	3
THE APPROACH: RETHINK EVERYTHING	4
FOCUSED ON LEADING EDGE RESEARCH	4
MEASUREMENT APPLICATIONS	5
SYSTEM OVERVIEW	6 - 7
ALL NEW SOFTWARE	8 - 9
MEASUREMENT SPEED IS KEY	10
OPTIMIZED FOR FORC DATA ACQUISITION	10
SYSTEM PICTURES WITH MAXIMUM FIELDS	11
PERFORMANCE DRIVEN	12
OBSERVED DATA	13
REPEATABLE AND CONVENIENT	14
GLIDELOCK™ TEMPERATURE OPTION ALIGNMENT	15
SYSTEM AND OPTION SPECIFICATIONS	16
8600 SERIES VSM EQUIPMENT	17
OPTIONS	18 - 21
QUICKLIGN™ SAMPLE RODS AND HOLDERS	22 - 25
SHIPPING AND INSTALLATION DIMENSIONS	26
SITE REQUIREMENTS	26
ORDERING INFORMATION	27 - 28

THE GOAL: CREATE AN ALL NEW VSM FAMILY WITH BEST-IN-CLASS PERFORMANCE AND USABILITY

The culmination of nearly 4 years of development, the 8600 Series VSM represents a new era in magnetometer measurement for today's researcher.

Leveraging the combined expertise of Lake Shore Cryotronics and Princeton Measurement Corporation (PMC), which Lake Shore acquired in 2013, our team of scientists and engineers approached development with one goal in mind: creating the most advanced electromagnet-based VSM capable of characterizing a broad range of materials with unprecedented ease and precision.



THE LAKE SHORE 8600 SERIES VSM TEAM.

MORE **SCIENCE**, LESS TIME

ADVANCED MEASUREMENT PERFORMANCE

The 8600 Series VSM raises the bar for magnetometer performance and convenience. These VSMs combine high sensitivity (15 nemu), rapid measurement speed (10 ms/pt), and simple operation for more accurate measurements, faster.

CONVENIENT OPERATION

The entire 8600 Series system has been reimagined with a focus on clean, ergonomic design that simplifies the researcher's interaction with the system. A motorized head brings the sample to a comfortable height for easy, one-handed exchange of the QuickLIGN™ sample rods. Temperature options include a cryostat, high-temperature oven, and single stage variable temperature insert. The combined temperature range of the options is 4.2 K to 1273 K. All three GlideLOCK™ options quickly slide into place and are auto-detected, with the software automatically displaying controls for the specific option. The magnet poles are also easily adjusted with the ExactGAP™ indexed positioning system that allows the pole gap to be set at one of six repeatable positions, eliminating the need to recalibrate after each change.

DESIGNED FOR FORC

The 8600 Series VSM was created with first order reversal curve (FORC) measurement as a primary objective. FORC analysis is greatly enhanced by the high sensitivity of the 8600 Series VSM. FORC also benefits from increased data point density, and the new VSM flies through complex FORC data collection sequences in a fraction of the time required on previous systems.

FLEXIBLE AND ADAPTABLE

The system's software simplifies control of the VSM. Standard predefined measurement routines are combined with configurable field and measurement loops to provide a flexible data acquisition environment. In addition, the software features an integrated scripting tool, which enables the user to extend the existing routines with an open-ended software scripting language that can be used to perform customized measurement protocols and interface with third-party lab equipment.

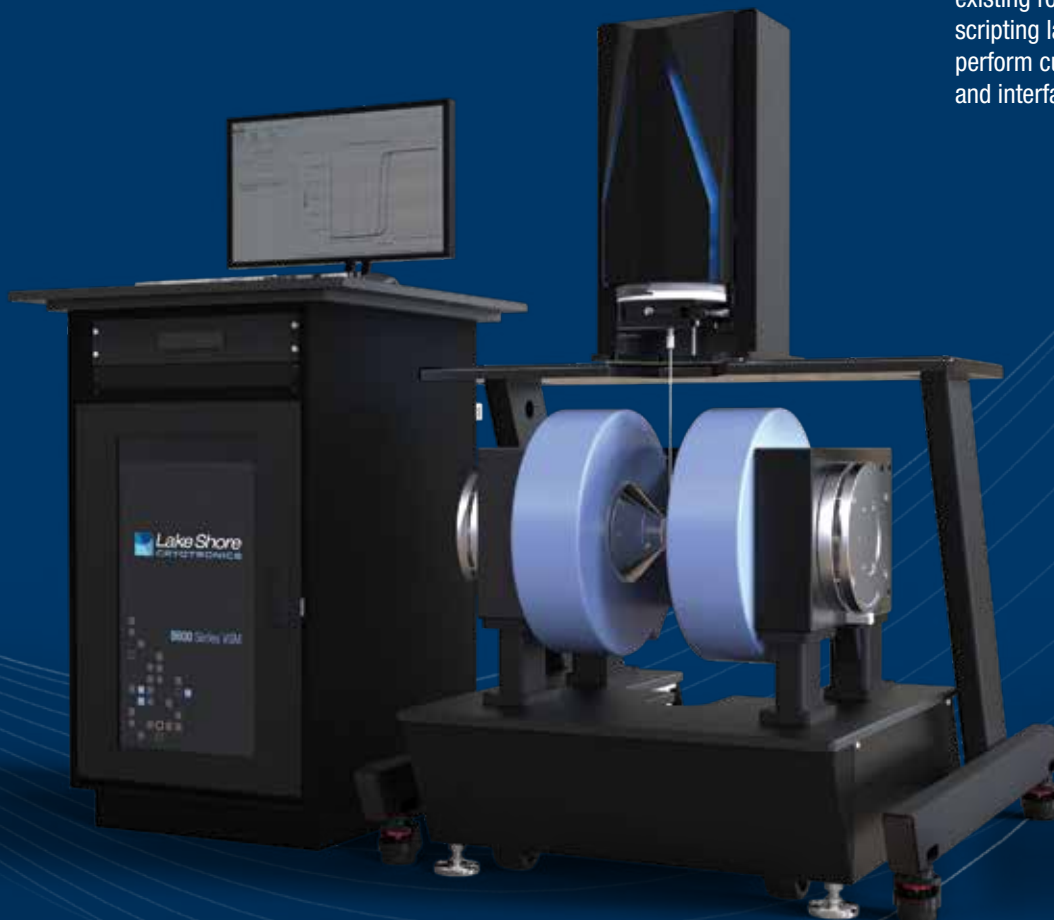

THE APPROACH: RETHINK EVERYTHING

As part of the project charter, the team had no constraints. Our approach was to design a completely new system for the ultimate in performance and usability.

We developed novel measurement techniques and reimagined each part of the system—from the mechanics of loading a sample to the fluidity of the all new software interface—to create a next generation VSM capable of quickly characterizing the magnetic properties of a broad range of materials, especially very low moment samples.

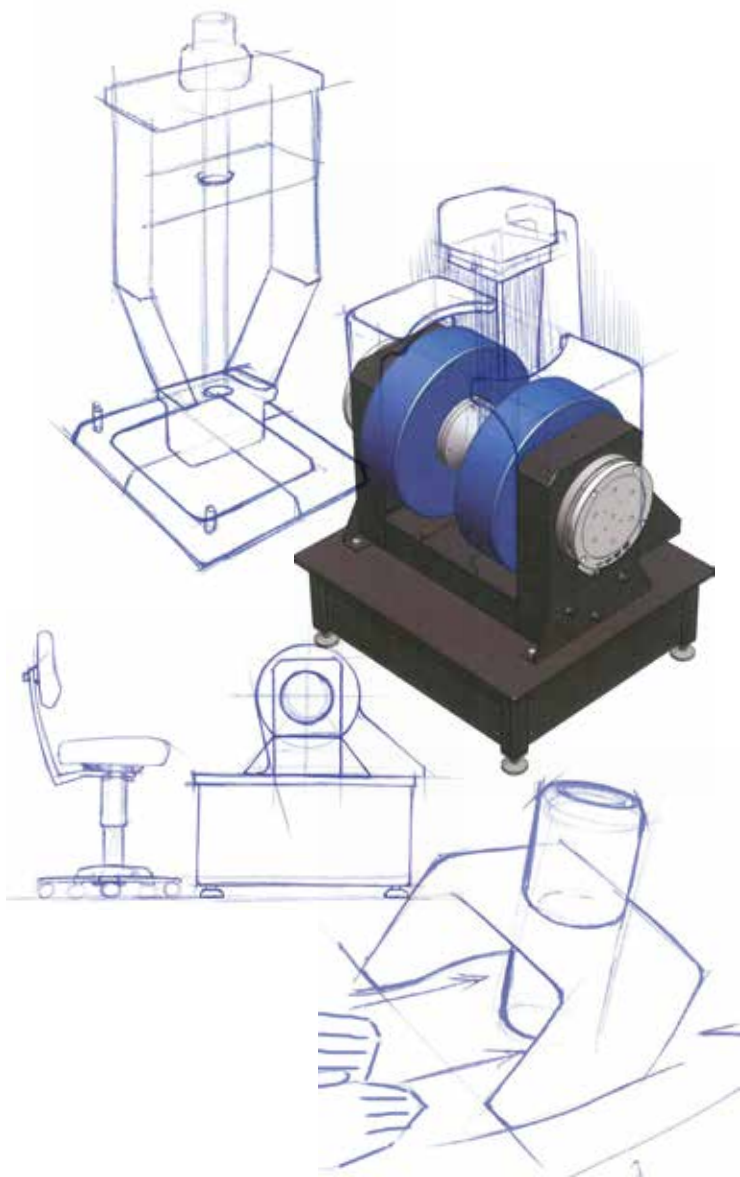

FOCUSED ON LEADING-EDGE RESEARCH

The 8600 Series VSM enables better measurements in less time, accelerating magnetics research and supporting the study of novel, low moment, and hybrid materials.

PERFORMANCE

Resulting from extensive design innovations that lower the noise floor and increase sampling speed, the 8600 VSM system brings new levels of measurement performance to magnetic characterization. The system features ultra-high sensitivity (down to 15 nemu), wide dynamic range, faster field ramping (10,000 Oe/s) and rapid data acquisition (up to 10 ms/pt). A complete -2 T to +2 T hysteresis loop with 3,000 measurement points can be completed in about 30 seconds.

Field setting resolution of 1 mOe is available across the entire measurement range, and especially helpful in regions where moment gradient ΔM is high. This fine resolution, combined with high sensitivity and fast measurement speed, make the 8600 Series ideal for first order reversal curve (FORC) measurements, which inherently involve very large data sets.

Lake Shore's significant background in FORC guided the 8600 Series development, which set out to ensure that FORC measurements were fully supported and convenient to make. The resulting new VSM system not only performs these complex measurement routines with great speed and precision, but also provides built-in tools to ensure that configuring and managing FORC profiles is very straightforward.

USABILITY

Convenience is a primary focus of the 8600 Series, starting with the QuickLIGN™ sample rod exchange, which can be accomplished easily with one hand. When variable temperature studies are needed via cryostat, oven, or wide-range SSVT, the 8600 Series VSM has significantly streamlined the process of adjusting the pole gap and installing and configuring the temperature option. Overall time required is reduced to well under 5 minutes, with the system software auto-detecting the type of temperature option and reconfiguring settings instantly.

While the 8600 Series software provides a broad range of measurement flexibility, Lake Shore knows that researchers are often interested in trying new measurement protocols. The software incorporates a full scripting engine and encourages users to either edit and adapt the standard protocol scripts provided, or create their own.

The powerful combination of measurement sensitivity, speed, integrated FORC routines, convenience, and adaptability make the 8600 Series VSM an ideal platform for advanced magnetics research.

MEASUREMENT APPLICATIONS

The need to characterize new and emerging materials continues to push the limits of electromagnet-based VSM systems. The 8600 Series VSM steps up to meet the most demanding material research applications.

Extremely fast data acquisition cycles make the system ideal for research environments where rapid measurement results can accelerate the discovery of important new properties. QuickLIGN™ sample holders are offered for thin film, liquid, powder, and bulk samples, making the VSM an excellent choice for busy labs with varying sample measurement needs.

The high sensitivity of the 8600 Series VSM particularly benefits research into low moment materials such as ultra-thin magnetic films and multilayers, nanoscale magnetic materials, dilute magnetic semiconductors, and paleomagnets.

The system benefits applications involving the study of:

- Natural magnets (rocks, sediments, etc.)
- Nanoscale wires, particles, nano-crystalline alloys, etc.
- Magnetic semiconductors
- Ferrofluids
- Magnetic thin films and multi-layers
- Ferrites and permanent magnets, including rare-earth materials
- Magnetocaloric effect materials

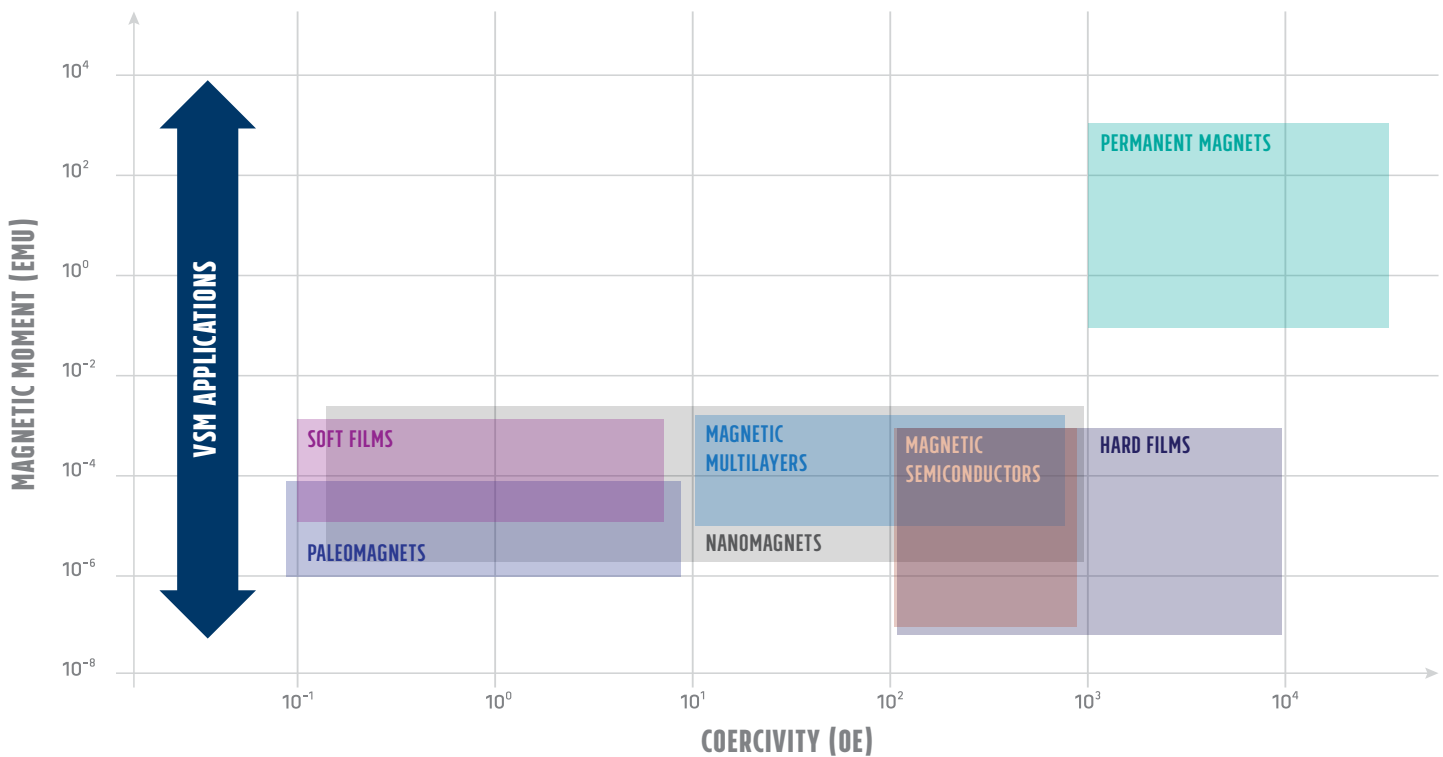

IDEAL FOR THE **BROADEST**
RANGE OF MAGNETIC MATERIAL
 CHARACTERIZATION APPLICATIONS

VERY EASY SAMPLE EXCHANGE — motorized head movement for sample extraction, allows for one-handed exchange of the QuickLIGN™ sample rods

EASY-TO-INSTALL TEMPERATURE OPTIONS — software automatically identifies and displays option-specific controls for installed GlideLOCK™ temperature options to quickly measure from 4.2 K to 1,273 K (8604/8607 only—see page 15 for more information)

UNATTENDED SINGLE-STAGE CONTROL — automatic switching between cryogenic to heated operations

REPEATABLE GAP SETTINGS — six indexed ExactGAP™ magnet positions each have their own saved calibration (8604/8607 only—see page 14 for more information)

THREE ELECTROMAGNET CONFIGURATIONS — choose from the 4 in, 7 in, or 10 in magnets for field requirements up to 3.62 T

STANDARD AUTOROTATION — continuous z-axis sample rotation, any angle

WIDE VARIETY OF SAMPLE HOLDERS — accommodate thin film, bulk, liquid, and powder samples

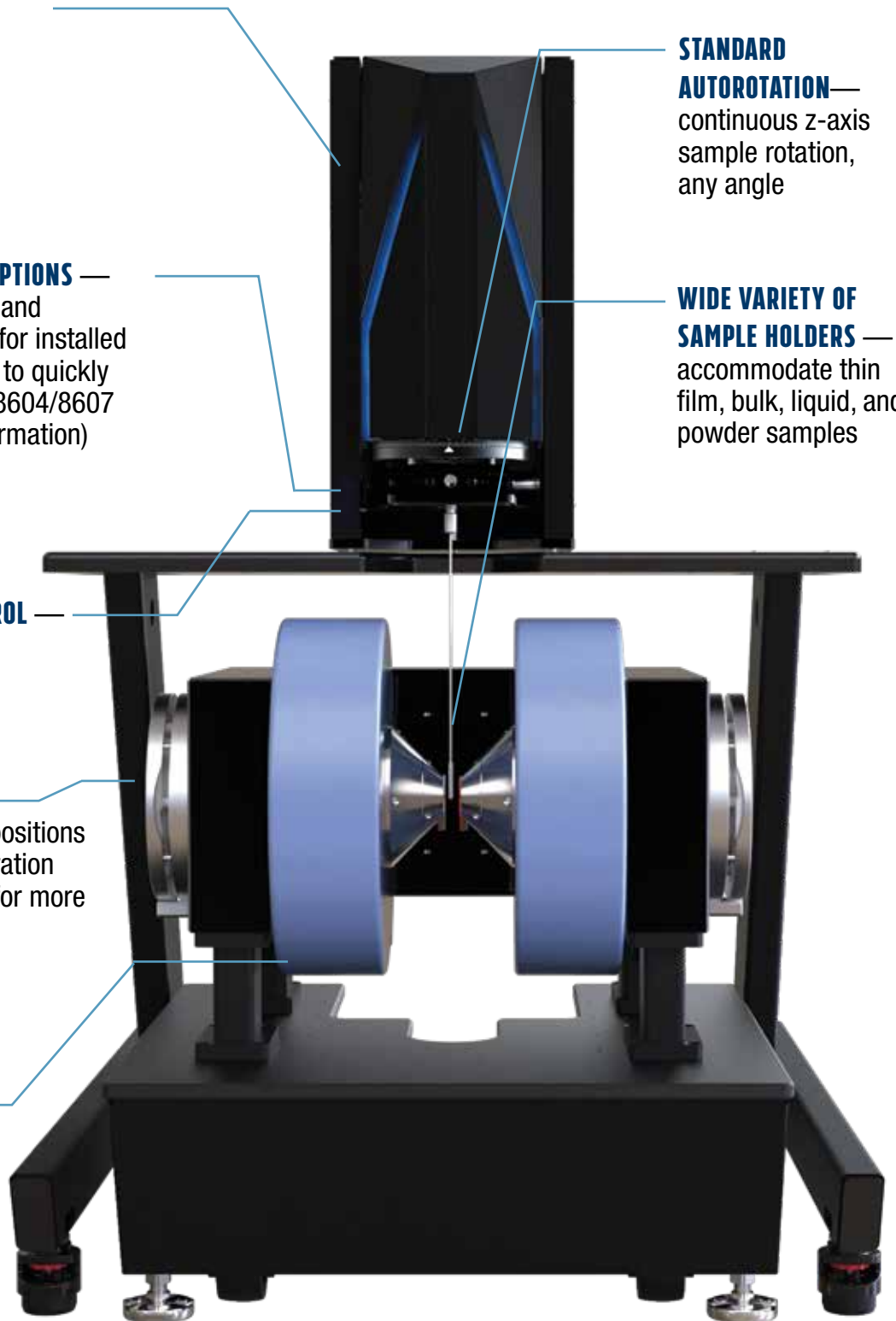



ALL NEW SOFTWARE — set up, execute routines and experiments with ease using sample measurement flow screens

ADVANCED SCRIPTING CAPABILITIES — customize your experiments with your own routines and integrations

INTEGRATED FORC MEASUREMENT — simple setup and rapid execution of complex FORC measurements

ERGONOMIC WORKSTATION WITH WIDESCREEN MONITOR —

in addition to housing all of the integrated electronics, the workstation acts as a convenient tabletop and has a drawer to store sample holders and samples

CONTROL ELECTRONICS — sensitive electromagnet-based VSM, featuring a noise floor as low as 15 nemu and moment stability of 0.05% per day

SENSITIVE, LOW NOISE FLOOR
ELECTROMAGNET-BASED
VSM SYSTEM FOR THE MOST
DEMANDING MEASUREMENTS

ALL NEW SOFTWARE

EASILY EXECUTE MEASUREMENT ROUTINES AND EXPERIMENTS

The 8600 Series comprehensive Windows®-based software simplifies the process of acquiring data. The flexible software allows the user to monitor the real-time performance of the VSM and to construct measurement sequences from a set of predefined controls. The menu-driven graphical user interface (GUI) provides the ability to control field and temperature to a specific setpoint or to loop these parameters through a range of settings with a specified step value. Predefined measurement controls are also provided to complete individual moment readings, hysteresis loops and even collect first order reversal curve (FORC) data. The sequences can be saved and recalled for repeated measurements.

The interface also simplifies the implementation of the three GlideLOCK™ temperature options (86-OVEN, 86-CRYO, and 86-SSVT) by automatically detecting and displaying each option as it is plugged into the system. With the integrated Model 705 gas controller, the software can provide automated, unattended VSM measurements throughout the entire temperature range (4.2 K to 1273 K).

Advanced data processing capabilities of the software include expand and offset data, correct for demagnetization and slope factors, normalize for sample mass and volume, subtract substrate corrections and backgrounds from measurement data, calculate and display derivative curves, and much more.

In addition to measuring magnetization curves and magnetization vs. time or temperature, the 8600 Series VSM provides insight for a host of measurements including:

- Hysteresis loop
- Isothermal remnant magnetization
- DC demagnetization remanence
- Minor loops
- FORC
- M(T)—temperature dependent magnetization
- M(θ)—rotational hysteresis and anisotropy

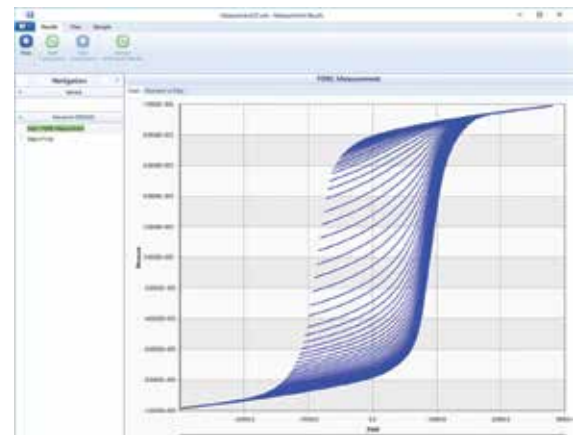
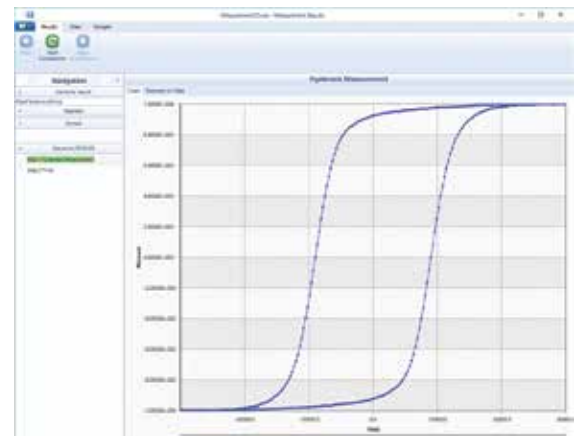
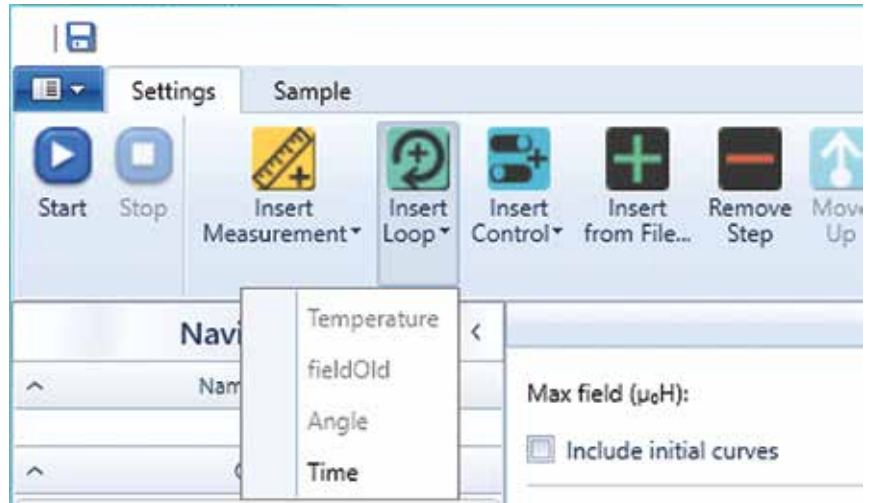

OPTION EXPLICIT

SUB MAIN

'START HYSTERESIS 1

SCRIPT.SETVOLTAGE TOMOMENTCALIBRATIONFACTOR 1, 1

SCRIPT.BEGINMEASUREMENTSTEP "1"

SCRIPT.SETSATURATIONPOINT(30000, 100000)

SCRIPT.SETDATAACQUISITIONPARAMS(DATAACQUISITIONMODE.CONTINUOUS, 2000, 0.1, 1, 0, 0)

DIM CHART AS MEASUREMENTCHART

CHART = SCRIPT.CREATECHART("1")

CHART.ADDXAXIS MEASUREMENTXAXISTYPE.FIELD, "FIELD"

CHART.ADDYAXIS MEASUREMENTYAXISTYPE.MOMENT, "MOMENT"

DIM INITIALCURVESERIES = NEW MEASUREMENTCHARTPLOTSERIES("INITIAL CURVE")

DIM DOWNWARDEXCURSIONSERIES = NEW MEASUREMENTCHARTPLOTSERIES("DOWNWARD EXCURSION")

DIM UPWARDDEXCURSIONSERIES = NEW MEASUREMENTCHARTPLOTSERIES("UPWARD EXCURSION")

CUSTOM SCRIPTING

For customized experiments, the 8600 Series VSM offers advanced scripting capabilities through an integrated interface easily accessible from the data acquisition tab in the software. Scripting is extremely useful for implementing customized VSM functionality that may not have been implemented in the standard software release. High level system calls are exposed so that the user can easily control the VSM data collection process and interweave external process calls. The script window enables you to capture the predefined measurements to view as a script. This is useful for understanding exactly how the 8600 is executing the measurements, but also provides an easy way to create a starting template for customized measurements. This powerful addition to the software puts the researcher fully in control of their unique measurement process.

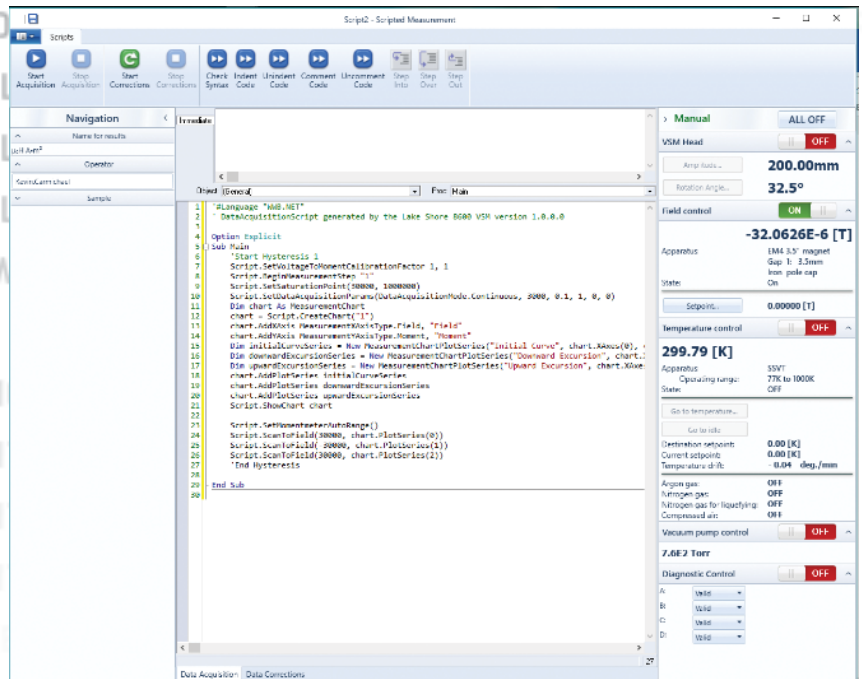

CUSTOMIZE
PRECONFIGURED SCRIPTS
OR **CREATE YOUR OWN**

MEASUREMENT SPEED IS KEY

While there have been many features included to make setup and data collection easy, the most notable feature in the 8600 Series VSM is the data acquisition speed. A complete change in the acquisition architecture permits an unprecedented data rate with exceptional, built-in noise suppression. The 8600 Series is capable of continuous 10 ms/point acquisition (100 points per second). A complete -2 T to +2 T hysteresis loop with 3,000 measurement points can be completed in less than 30 seconds.

10 MS/POINT
DATA ACQUISITION

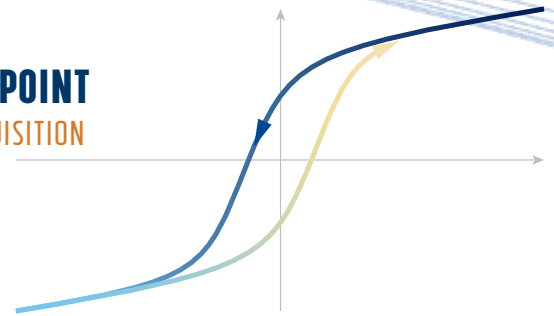

OPTIMIZED FOR FORC DATA ACQUISITION

First order reversal curves (FORCs) provide information regarding magnetic interactions and coercivity distributions which cannot be obtained from measurements of a materials hysteresis loop alone. FORC measurements can be helpful in studying materials such as:

- FORC has long been the standard measurement and analysis protocol used by earth and planetary scientists studying the magnetic properties of natural samples because FORC can distinguish between single-domain (SD), multi-domain (MD), and pseudo single-domain (PSD) behavior and because it can distinguish between different magnetic mineral species.
- FORC is relevant to any material composed of fine (micron- or nano-scale) magnetic particles, which includes a broad array of magnetic materials (e.g., permanent magnets, recording media, magnetic nanowires and dots).
- The complex magnetic signatures of multi-phase magnets is difficult, if not impossible, to unravel from a hysteresis loop measurement alone. FORC can distinguish between phases in magnetic materials containing more than one phase (e.g., exchange spring magnets, soft shell/hard core nanowires)

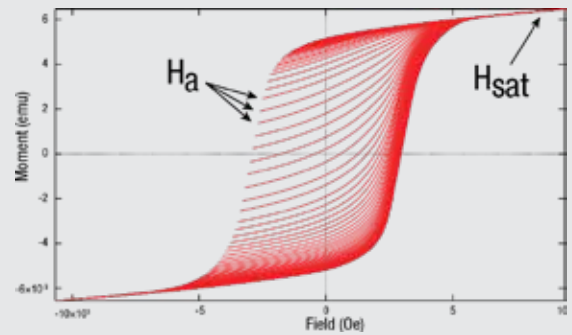

A FORC is measured by saturating a sample in a field H_{sat} , decreasing the field to a reversal field H_a , then sweeping the field back to H_{sat} in a series of regular field steps. This process is repeated for many values of H_a , yielding a series of FORCs that can be exported for further analysis.

Because FORCs may contain many thousands of data points, measurement speed is critical to productive research. However, data point quantity alone is not enough. FORC requires adherence to specific data collection protocols in order for the subsequent analysis to be meaningful.

The 8600 Series VSM has been specifically designed to execute FORC measurements quickly and easily, and with high precision. 10,000-point FORCs can be completed in minutes.

Proven FORC data acquisition protocols are built into the standard 8600 VSM system software and are very easy to set up, run, and modify. FORC data sets, once acquired, are readily exported for analysis using FORCinel* or similar third-party tools to render distribution plots of interaction and switching fields. In addition, the system includes Real-Time FORC (RTForc™) software, which enables fully automated FORC data acquisition using the 8600 Series software.

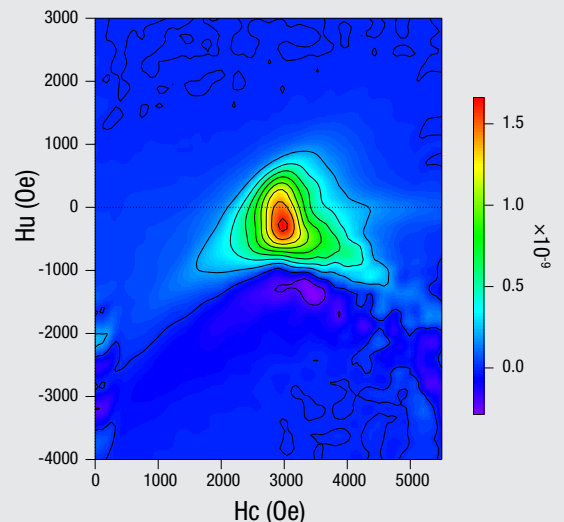

FORCs are indispensable in characterizing interactions and coercivity distributions that reveal insight into the relative proportions of reversible and irreversible components of the magnetization in many technologically important magnetic materials. The 8600 Series VSM is the best VSM in the industry for convenient, productive, and accurate FORC measurement.

*R.J. Harrison, J.M. Feinberg, *FORCinel: An Improved Algorithm for Calculating First-Order Reversal Curve Distributions Using Locally Weighted Regression Smoothing*, *Geochemistry, Geophysics, Geosystems*, 9, 11, 2008. FORCinel may be downloaded from: <https://earthref.org/FORCinel/>.

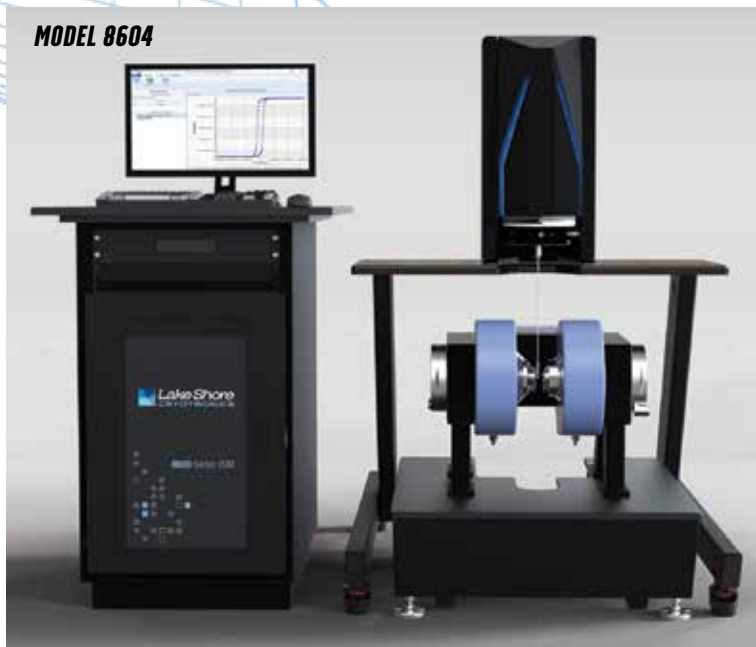

**MAXIMUM FIELD
2.76 T**

**MAXIMUM FIELD
3.22 T
COMPARABLE TO MODEL 7410-S**



**MAXIMUM FIELD
3.62 T**



PERFORMANCE DRIVEN

Compare the 8600 Series with the 7400 Series VSM

6X MOMENT SENSITIVITY
15 nemu at
IMPROVEMENT room temperature

50X FIELD RAMP RATE
IMPROVEMENT 10,000 Oe/s

10X DATA COLLECTION SPEED
IMPROVEMENT 10 ms/pt

3X TEMPERATURE OPTION CHANGE
IMPROVEMENT Under 5 min

20X FIELD SETTING RESOLUTION
IMPROVEMENT 1 mOe

OBSERVED DATA

Noise at 10 s/point averaging at ExactGAP™ Index 1. The observed noise is only 13 nemu RMS and 50 nemu peak-to-peak.

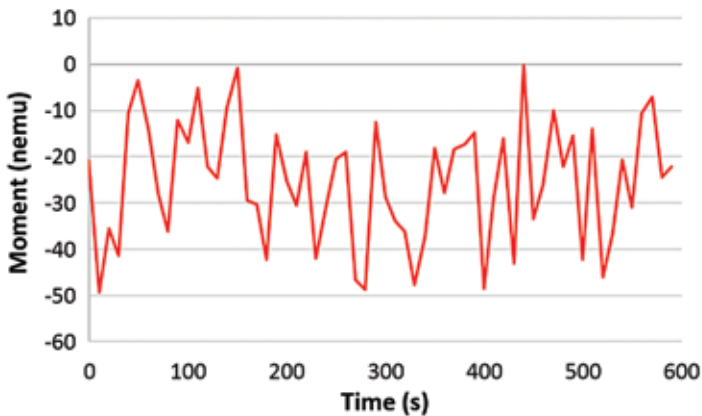

13 s hysteresis loop at 10 ms/point for a 14 memu magnetic stripe.

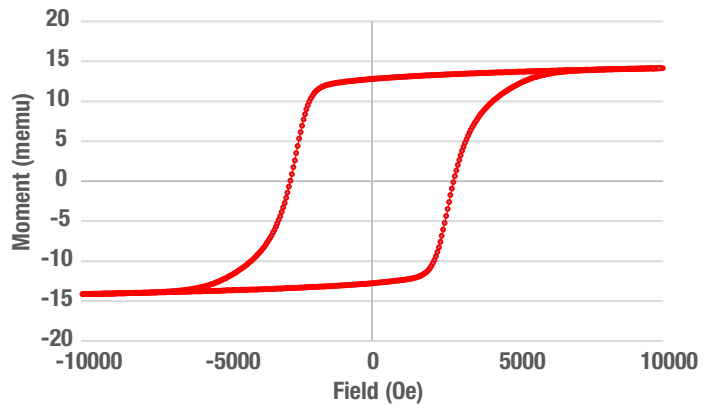

RMS noise (μemu) versus gap and signal averaging for the 8600 VSM.

ExactGAP™ setting	10 s/pt	1 s/pt	100 ms/pt	10 ms/pt
Index 1	0.013	0.04	0.12	0.30
Index 3 (SSVT option)	0.07	0.27	0.78	2.2

69 s hysteresis loop at 100 ms/point for a 80 μemu CoPt thin film.

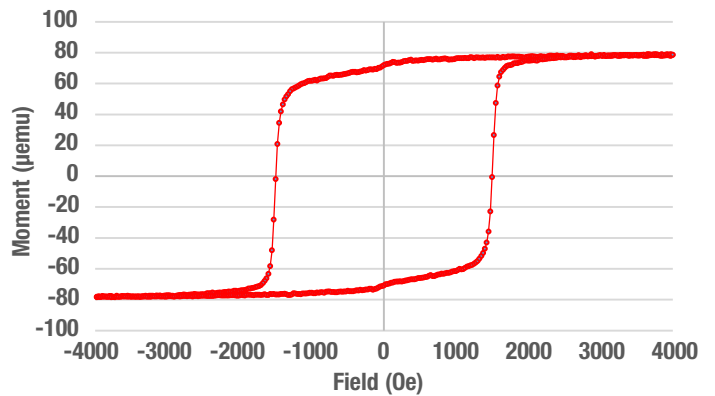

1 min 25 s hysteresis loop at 100 ms/point for a 20 μemu CoPt thin film.

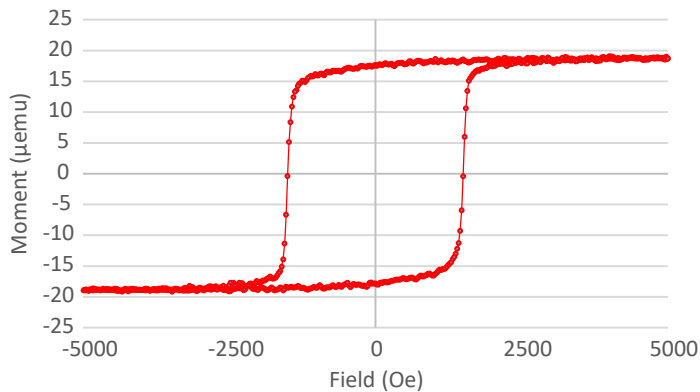

4 min 32 s measurement of 46 FORCs for a 14 memu magnetic stripe.

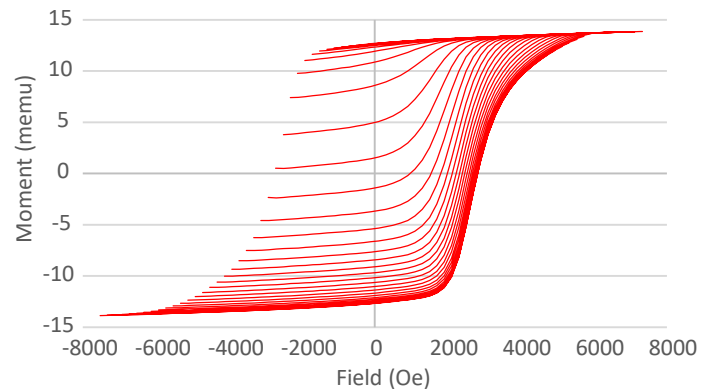

13 min 30 s hysteresis loop at 1 s/point for a 20 μemu CoPt thin film.

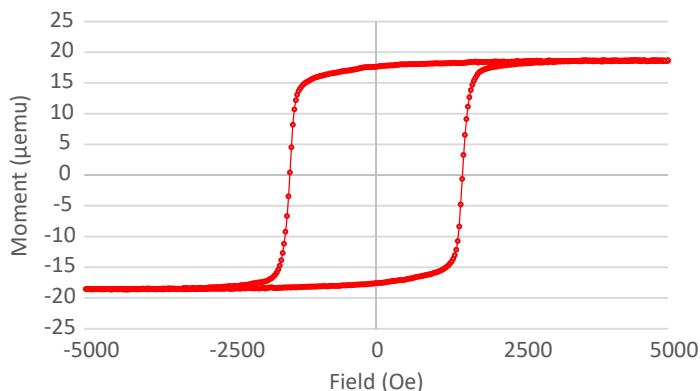

REPEATABLE AND CONVENIENT

EASY SAMPLE ROD EXCHANGE AND SAMPLE ROTATION

The 8600 Series VSM's motorized head brings the sample to a comfortable height for easy exchange of sample rods. The QuickLIGN™ quick-release coupling mechanism allows the rod to slide smoothly into the measurement collar and lock securely in place.

The autorotation feature offers full software-based control over sample rotation about the z-axis. The sample can be continuously rotated in either direction.

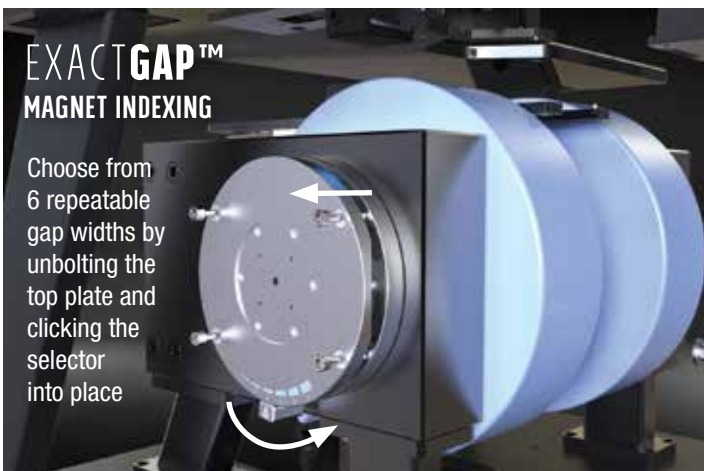
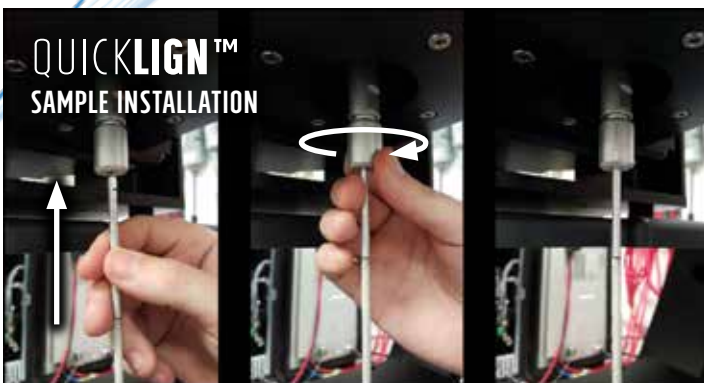

ELECTROMAGNET AND SAMPLE HOLDER OPTIONS

The 8600 Series VSM offers three models based on variable-gap 4-inch, 7-inch, or 10-inch electromagnets, all of which offer a stability of 0.05%/day. The ExactGAP™ pole gap indexing of the 4 in and 7 in magnets makes it fast and easy to reconfigure the magnet gap for the required sample or option size. A variety of sample holders accommodate thin films, solids, powders, liquids, and bulk materials.

RAPID TEMPERATURE OPTION CHANGE

8600 Series GlideLOCK™ variable temperature options include a low-temperature LHe/LN₂ cryostat, a high-temperature oven, and single stage variable temperature (SSVT) insert. All three quickly click into place and are auto-detected, the software automatically displaying controls for the specific option. GlideLOCK™ is available on 8604 and 8607. The 8610 uses alternate mounting with software selection of the VT option instead of auto-detection.

ExactGAP™ repeatable pole gap indexing in the 8604 and 8607 minimizes delays when an option change is required. Use preset gap settings for each temperature option or sample holder to quickly move the caps to a precise, precalibrated position, and do so repeatedly without having to manually recalibrate for each setting.



AUTOMATED WIDE TEMPERATURE OPERATION

When using the temperature options, the 8600 Series VSM supports fully automated unattended variable temperature operation across the full temperature range of each option spanning 4.2 K to 1273 K. The Model 705 gas controller automates the gas handling and manages the exhaust gas to prevent unsafe venting of extreme temperature gases and icing of exhaust port when venting cryogenic gases. The 705 is currently only available for the 8604 and 8607.

THESE FEATURES WORK
TOGETHER TO PROVIDE
THE MOST **PRECISE**
POSITIONING POSSIBLE

GLIDELOCK™ TEMPERATURE OPTION ALIGNMENT

The GlideLOCK™ alignment system was created to simplify the insertion and removal of all three temperature options into 8604 and 8607 VSMs providing rapid, repeatable sample positioning in all configurations.

1. Slide the GlideLOCK mounting tray out from the magnet.

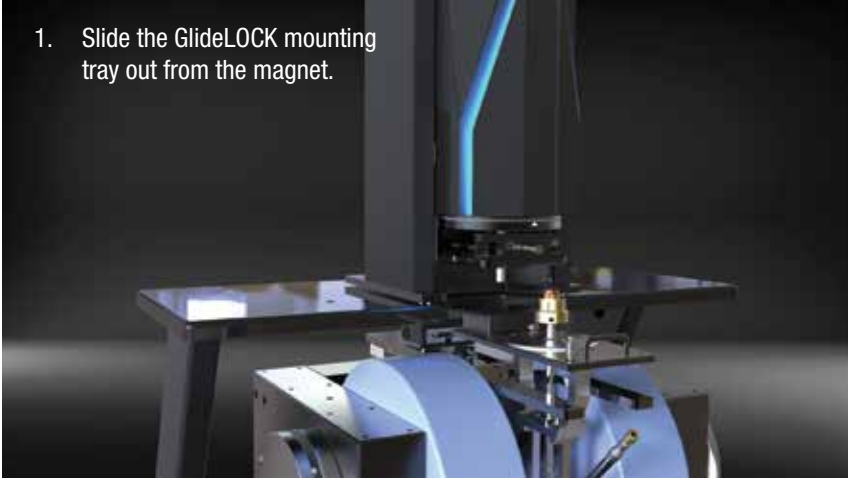

2. Place the temperature option onto the GlideLOCK tray and engage the alignment pin.

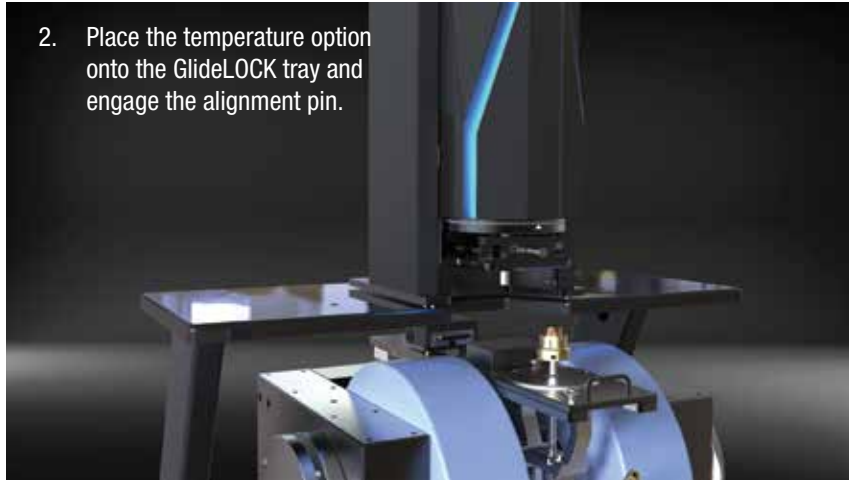

3. Slide the tray back in to the magnet to precisely engage the temperature option.

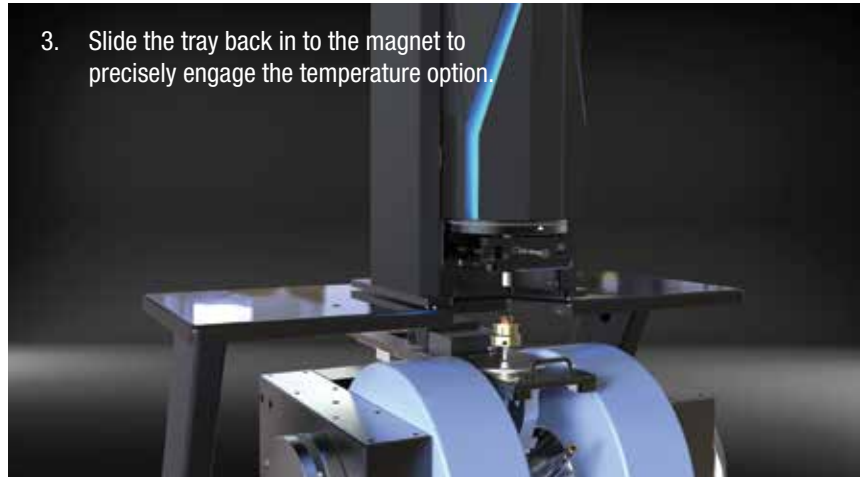

8600 SERIES VSM SPECIFICATIONS

APPLIED FIELD STRENGTH WITH OPTIONAL HIGH FIELD POLE CAPS (±1%)					
<small>GAPS 4 & 6 SUPPORT NON-VSM APPLICATIONS</small>	Sample space	Sample size with option	8604 maximum field	8607 maximum field	8610 maximum field (high-field pole caps are standard on the 8610)
Gap index 1	3.5 mm (0.14 in)	N/A	27.6 kOe (2.76 T)	32.2 kOe (3.22 T)	36.2 kOe (3.62 T)
Gap index 2	8 mm (0.31 in)	N/A	25.2 kOe (2.52 T)	29.8 kOe (2.98 T)	33.7 kOe (3.37 T)
Gap index 3	16 mm (0.63 in)	6.4 mm (0.25 in) with SSVT	20.3 kOe (2.03 T)	26.0 kOe (2.60 T)	29.8 kOe (2.98 T)
Gap index 5	24 mm (0.94 in)	6.4 mm (0.25 in) with oven or cryostat	15.5 kOe (1.55 T)	22.7 kOe (2.27 T)	26.3 kOe (2.63 T)

APPLIED FIELD STRENGTH WITH STANDARD POLE CAPS (±1%)					
<small>GAPS 4 & 6 SUPPORT NON-VSM APPLICATIONS</small>	Sample space	Sample size with option	8604 maximum field	8607 maximum field	8610 maximum field (high-field pole caps are standard on the 8610)
Gap index 1	3.5 mm (0.14 in)	N/A	26.1 kOe (2.61 T)	30.5 kOe (3.05 T)	36.2 kOe (3.62 T)
Gap index 2	8 mm (0.31 in)	N/A	23.7 kOe (2.37 T)	28.3 kOe (2.83 T)	33.7 kOe (3.37 T)
Gap index 3	16 mm (0.63 in)	6.4 mm (0.25 in) with SSVT	19.6 kOe (1.96 T)	24.7 kOe (2.47 T)	29.8 kOe (2.98 T)
Gap index 5	24 mm (0.94 in)	6.4 mm (0.25 in) with oven or cryostat	15.4 kOe (1.54 T)	21.7 kOe (2.17 T)	26.3 kOe (2.63 T)

MOMENT MEASUREMENT	
Noise floor (emu RMS)	
Room temperature	
0.1 s/pt	150 nemu
1 s/pt	60 nemu
10 s/pt	15 nemu
With oven or cryostat option	
10 s/pt	300 nemu
With SSVT option (8604 and 8607 only)	
10 s/pt	90 nemu
With vector coil option (8604 and 8607 only)	x coils: 90 nemu at Exact GAP 3; y coils: 200 nemu at ExactGAP 3
Dynamic range	25×10^{-9} to 10^3 emu
Moment stability	Better than ±0.05% of full scale/day for fixed coil geometry at constant field and temperature
Reproducibility	Better than ±0.5% or ±0.1% of full scale, fixed rotation angle and range, with sample replacement
Moment accuracy	Better than 1% of reading ±0.2% of full scale with a geometrically identical test sample and calibrant
Sample mass	0 g to 10 g

FIELD MEASUREMENT	
Field accuracy	1% of reading or ±0.05% of full scale
Field resolution	8604/8607: 100 nT (1 mOe); 8610: 1 μT (10 mOe)
Field ramp rate	Up to 1 T/s (10,000 Oe/s)
Closed-loop field control stability	8604/8607: 100 nT (1 mOe); 8610: 1 μT (10 mOe)

SAMPLE ROTATION	
Setting resolution	0.1°
Setting reproducibility	<1°
Rotation range	Continuous

CERTIFICATIONS	
CE	Yes
Application of Council directives	2014/35/EU Low Voltage Directive 2014/30/EU EMC Directive 2011/65/EU RoHS Directive
Standard to which conformity is declared	EN61010-1: 2010 Overvoltage Category II, Pollution Degree 2; EN61326-1: 2013 Class A, Controlled EM Environment; EN55011: 2009 Class A, Controlled EM Environment; EN50581: 2012

UTILITIES	
Total system cooling water power dissipation (50 or 60 Hz) — see list of available recirculating chillers	8604: 4250 W 8607/8610: 13400 W

8600 SERIES OPTION SPECIFICATIONS

MODEL 86-CRYO/8610-CRYO VARIABLE TEMPERATURE CRYOSTATS		
With LHe temperature range	4.2 K base, 5.5 K to 420 K control	
LHe temperature stability	±0.1 K	
With LN ₂ temperature range	77 K base, 85 K to 420 K control	
LN ₂ temperature stability	±0.2 K	
Temperature resolution	0.001 K	
Cool-down time	5 min (15 min initial cool-down)	
Operation method	Continuous flow	
LHe liquid usage	1 L/h when operating >7 K	
LN ₂ liquid usage	1 L/h when operating >85 K	
Insulation	Vacuum	
Sample zone dimensions	Bore size	7.1 mm (0.28 in)
	Outside diameter	22.4 mm (0.88 in)

MODEL 86-OVEN/8610-OVEN HIGH TEMPERATURE OVENS		
Temperature range	Room temperature (308 K with 8610) to 1273 K	
Temperature stability	±0.1 K	
Temperature resolution	0.001 K	
Nominal ramp rate	5 K/min	
Insulation	Vacuum plus multiple reflective shields	
Sample zone dimensions	Bore size	7.3 mm (0.29 in)
	Outside diameter	19 mm (0.75 in)

MODEL 86-SSVT SINGLE STAGE VARIABLE TEMPERATURE OPTION (8604 AND 8607 ONLY)		
Temperature range	77 K (base), 100 K to 950 K (control)	
Temperature stability	0.1 K RMS	
Temperature resolution	0.001 K	
Gasses	LN ₂ and nitrogen gas for T < 350 K; argon for T > 350 K	
Cool-down time	40 min from room temperature to 100 K	
Nominal ramp rate (in the domain)	Up to 8 K/min	
Operating method	Continuous flow	
LN ₂ usage	0.5 L/h >100 K to 350 K	
Nitrogen gas usage	<3 L/min	
Argon gas usage	<3 L/min	
Insulation	Vacuum	
Sample zone dimensions	Bore size	7.8 mm (0.31 in)
	Outside diameter	12.7 mm (0.5 in)

8600 SERIES VSM EQUIPMENT

	8604	8607	8610
VSM head drive		Gen2	
VSM frame		V-mag	
Control electronics		Model 737	
Bipolar magnet power supply	Model 643		Model 648
Maximum output	±35 V/±70 A (2450 W)		±75 V/±135 A (9.1 kW nominal)
AC line input	204/8 VAC ±10%, 13 A/phase; 220/230 VAC ±10%, 12 A/phase; 380 VAC ±10%, 7 A/phase; 400/415 VAC ±10%, 6.5 A/phase at 50/60 Hz		200 VAC ±5%, 41 A/phase; 208 VAC ±5%, 40 A/phase; 220 VAC ±5%, 38 A/phase; 230 VAC ±5%, 37 A/phase; 380 VAC ±5%, 23 A/phase; 400 VAC ±5%, 21 A/phase; 415 VAC ±5%, 21 A/phase
Cooling water requirements	Tap water or closed cooling system (optional chiller available) +15 °C to +30 °C		
Flow rate	5.7 L (1.5 gal)/min minimum		7.6 L (2.0 gal)/min minimum
Pressure drop	10 kPa (1.5 psi) minimum for power supply only		159 kPa (23 psi) minimum for power supply and mandatory flow switch
Electromagnet	Model EM-4V	Model EM-7V	Model EM-10V
Pole diameter	100 mm (4 in)	180 mm (7 in)	254 mm (10 in)
Pole cap face diameter	50 mm (2 in)	50 mm (2 in)	50 mm (2 in)
Field homogeneity (ExactGAP™ Index 2)	±0.1% over 10 mm ³ (0.4 in ³)	±0.1% over 10 mm ³ (0.4 in ³)	±0.1% over 10 mm ³ (0.4 in ³)
Cooling water requirements	Tap water or closed cooling system (optional chiller available)		
Inlet temperature		15 to 25 °C (59 to 77 °F)	
Flow rate	7.6 L (2 gal)/min	11.4 L (3 gal)/min	15 L (4 gal)/min
Pressure drop	250 kPa (36 psi)	250 kPa (36 psi)	200 kPa (30 psi)
Hall probe		86-0911	
Sense coils		Model 86-LC	
Instrument console		483 mm (19 in) rack	

Please note: chiller power specifications listed are for 100% duty cycle. Many common magnet testing applications such as hysteresis loops will not require as much cooling power. Please consult Lake Shore for chiller recommendations for your specific applications.

EXPAND YOUR CAPABILITIES WITH **OPTIONS**

TEMPERATURE OPTION OPERATING RANGES

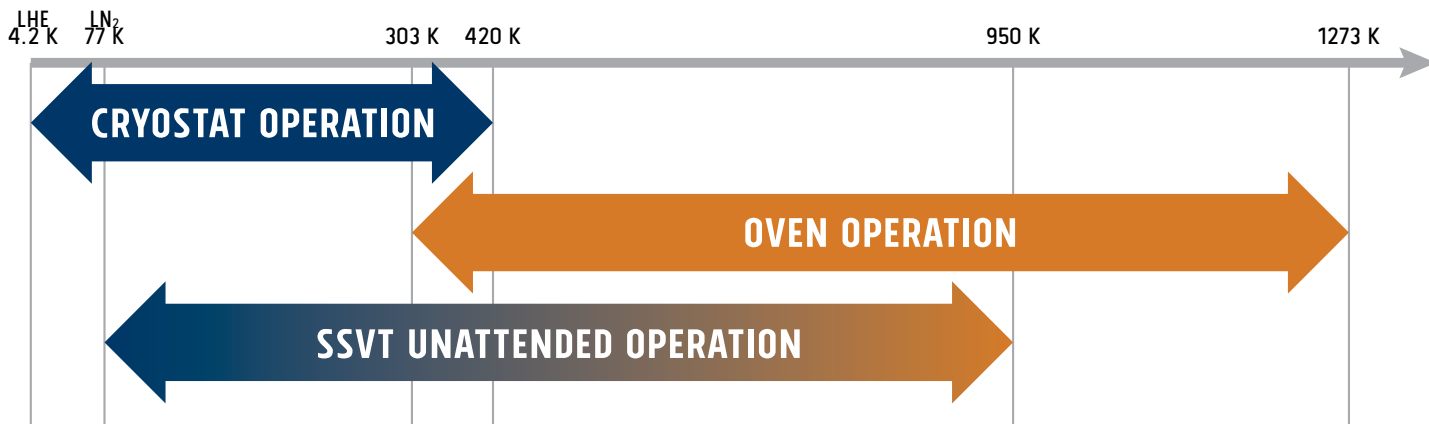

86-SSVT SINGLE STAGE VARIABLE TEMPERATURE OPTION WITH GLIDELOCK™ ALIGNMENT SYSTEM (8604/8607 ONLY)

The single stage variable temperature assembly allows you to take measurements from 100 K to 950 K using LN₂, nitrogen, and argon gas. A single point measurement can be taken at 77 K. The fully automated 705 gas controller permits the user unattended operation from high to low temperatures, eliminating the need to remove or resaddle your sample. This ensures accurate measurements throughout the full operating range. Rapid cooldown from 950 K to room temperature and from room temperature to 100 K provides efficiency and high throughput. Like our full suite of variable temperature options, the single stage variable temperature option uses the GlideLOCK alignment system to simplify option insertion and produce repeatable sample positioning, ensuring optimum noise floor. Designed to deliver superior thermal performance, the unit's vacuum insulation prevents freeze over at low temperatures and can operate safely at high temperatures without the risk of damaging neighboring components.

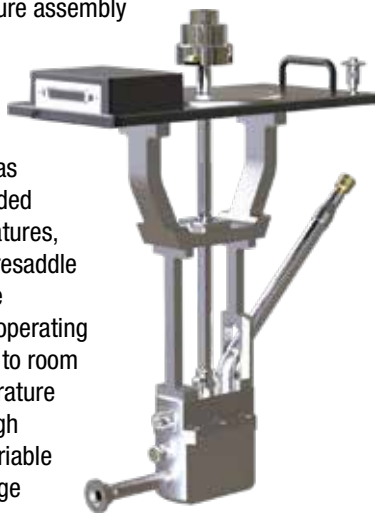

Included with the 86-SSVT:

1. Single stage variable temperature insert with GlideLOCK mount
2. 35 L LN₂ Dewar with condenser stand
3. LN₂ transfer line with condenser assembly
4. Instrument cables
5. Sample rods and holders
6. Wall mount bracket to store option when not in use

Supplemental 86-SSVT equipment requirements:

1. Lake Shore 86-VTA variable temperature option kit
2. Lake Shore 705 gas controller
3. Argon gas cylinder with 344 kPa (50 psi) gas regulator and 3 mm hose barb (can also be a ¼ NPT female fitting)
4. Nitrogen gas cylinder with a 344 kPa (50 psi) gas regulator and 3 mm hose barb (can also be a ¼ NPT female fitting)
5. LN₂ source to fill the provided Dewar
6. Clean compressed air (276 kPa [40 psi])
7. Lake Shore TPS-FRG compact turbo pumping system (required for full automation) or mechanical vacuum pump (E2M or equivalent) kit providing sample space blank off pressure of 0.67 Pa (5×10^{-3} Torr) for routine operation
8. Turbomolecular vacuum pump (Lake Shore TPS-FRG or equivalent) kit for cryogen transfer line maintenance — can also be used in place of the E2M rotary vacuum pump
9. A Pirani or thermocouple vacuum gauge capable of measuring pressures from 0.1 to 100 Pa (10^{-3} to 1 Torr)

CONFIGURE YOUR SYSTEM—**EXACTLY** THE WAY YOU NEED IT

86-CRYO VARIABLE TEMPERATURE CRYOSTAT WITH GLIDELOCK™ ALIGNMENT SYSTEM (8604/8607 ONLY)



This VSM cryostat is designed for rapid sample cooling with either LHe or LN₂ as well as easy sample insertion and interchange. It allows you to take measurements from 5.5 K to 420 K using LHe and from 85 K to 420 K using LN₂. A single-point measurement can be taken at 4.2 K (LHe) and at 77.6 K (LN₂). The sample is suspended in a proprietary insulated tube constructed of nonmagnetic material.

Like our full suite of variable temperature options, 86-CRYO cryostat uses the GlideLOCK alignment system to simplify option insertion and produce repeatable sample positioning and ensuring optimum noise floor.

The cryostat design provides the user the capability to perform measurements economically over nearly the entire accessible temperature range with a single cryostat. The transfer line is included.

Included with the 86-CRYO:

1. Combination LHe/LN₂ cryostat with GlideLOCK mount
2. LHe/LN₂ transfer line
3. Cryogen transfer kit
4. Instrument cables and related accessories
5. Sample rods and holders
6. Wall mount bracket to store option when not in use

Supplemental 86-CRYO equipment requirements:

1. Lake Shore 86-VTA temperature option kit
2. A mechanical vacuum pump (Lake Shore E2M or similar) capable of achieving a pressure below 0.67 Pa (5×10^{-3} Torr) and a speed of 1 m³/h, along with a KF-16 flange pump inlet
3. Access to turbomolecular vacuum pump (Lake Shore TPS-FRG or similar) capable of doing better than 1.33×10^{-3} Pa (10^{-6} Torr) for annual evacuation of transfer line vacuum space
4. LHe or LN₂ storage Dewar (Lake Shore 1220-50 or similar) with top withdraw fitting to accept the 12.8 mm (0.5 in) diameter transfer line — the transfer line furnished with the 86-CRYO cryostat is particularly well adapted for use with 25 to 60 L storage vessels, and can be readily adapted to other capacity storage vessels (in most cases, a LHe Dewar will be provided by your local liquid gas distributor when LHe is delivered)
5. Gas cylinder with 1 to 5 psi pressure regulator to deliver clean, dry helium or nitrogen gas (depending on liquid cryogen)

86-OVEN HIGH TEMPERATURE OVEN WITH GLIDELOCK™ ALIGNMENT SYSTEM (8604/8607 ONLY)

The high temperature oven is used to investigate materials at high temperature. It is an electrically heated outer tube assembly with thermal insulation for sample-zone temperatures from 100 °C to 1000 °C (373 K to 1273 K). Temperatures from 30 °C to 1000 °C (303 K to 1273 K) are also possible, however, below 100 °C (373 K) measurement time increases. Argon gas inside the sample chamber enhances heat flow with the sample. The 705 gas controller can be added as an option to automatically stop the argon feed after the measurement is completed, but the 705 is not required for the 86-OVEN option.

The sample zone chamber is lined with a heat-resistant and intrinsically non-magnetic material. The provided sample holder is a quartz tube sample rod attached to a boron-nitride sample cup. The 86-OVEN uses the GlideLOCK alignment system to simplify insertion and produce repeatable sample positioning and optimum noise floor.

To accommodate the oven within the magnet, ExactGAP index 5 is required. A mechanical vacuum pump capable of maintaining inlet pressures down to 0.67 Pa (5×10^{-3} Torr) must be supplied by the user.

The efficient thermal insulation consists of an evacuation outer chamber with multiple reflective heat shields. Sample zone temperatures as high as 1000 °C are attained with a power consumption of approximately 70 W. Two results of the low power consumption are minimal magnetic interference and increased temperature uniformity in the sample zone. The oven is particularly well suited to measuring Curie temperatures of ferromagnetic or ferrimagnetic materials at temperatures up to 1000 °C. The sensitivity of the VSM permits Curie temperature determinations at relatively low field intensities, allowing more inherently accurate determinations.

At room temperature and above, measurements may be performed in an argon atmosphere to protect the sample from oxidation.

Included with the 86-OVEN:

1. Oven assembly with mount
2. Nickel Curie sample cylinder
3. Instrument cables and related accessories
4. Sample rods and holders

Supplemental 86-OVEN equipment requirements:

1. Lake Shore 86-VTA temperature option kit
2. Lake Shore 705 gas controller (optional, but not required)
3. A mechanical vacuum pump (Lake Shore E2M or similar) capable of achieving a blanked-off pressure below 0.67 Pa (5×10^{-3} Torr) and a pumping speed of 1 m³/h, with a KF-16 flange pump inlet
4. Argon gas cylinder with 5 to 10 psi regulator and 3 mm (1/8 in) hose barb

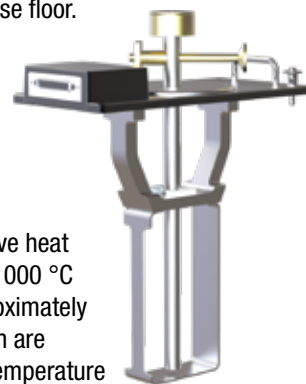

8610-CRYO VARIABLE TEMPERATURE CRYOSTAT (8610 ONLY)

This VSM cryostat is used with the 8610 VSM and is designed for rapid sample cooling with either LHe or LN₂ as well as easy sample insertion and interchange. It allows you to take measurements from 5.5 K to 420 K using LHe and from 85 K to 420 K using LN₂. A single-point measurement can be taken at 4.2 K (LHe) and at 77.6 K (LN₂). The sample is suspended in a proprietary insulated tube constructed of nonmagnetic material.

The cryostat design provides the user the capability to perform measurements economically over nearly the entire accessible temperature range with a single cryostat. The transfer line is included.

Included with the 8610-CRYO:

1. Combination LHe/LN₂ cryostat with mount
2. LHe/LN₂ transfer line
3. Cryogen transfer kit
4. Instrument cables and related accessories
5. Sample rods and holders
6. Wall mount bracket to store option when not in use

Supplemental 8610-CRYO equipment requirements:

1. Lake Shore 8610-VTA temperature option kit
2. A mechanical vacuum pump (Lake Shore E2M or similar) capable of achieving a pressure below 0.67 Pa (5×10^{-3} Torr) and a speed of 1 m³/h, along with a KF-16 flange pump inlet
3. Access to turbomolecular vacuum pump (Lake Shore TPS-FRG or similar) capable of doing better than 1.33×10^{-3} Pa (10^{-6} Torr) for annual evacuation of transfer line vacuum space
4. LHe or LN₂ storage Dewar (Lake Shore 1220-50 or similar) with top withdraw fitting to accept the 12.8 mm (0.5 in) diameter transfer line — the transfer line furnished with the 8610-CRYO cryostat is particularly well adapted for use with 25 to 60 L storage vessels, and can be readily adapted to other capacity storage vessels (in most cases, a LHe Dewar will be provided by your local liquid gas distributor when LHe is delivered)
5. Gas cylinder with 1 to 5 psi pressure regulator to deliver clean, dry helium or nitrogen gas (depending on liquid cryogen)

8610-OVEN HIGH TEMPERATURE OVEN (8610 ONLY)

8610-OVEN is used with the 8610 VSM to investigate materials at high temperature. It is an electrically heated outer tube assembly with thermal insulation for sample-zone temperatures from 100 °C to 1000 °C (373 K to 1273 K). Temperatures from 35 °C to 1000 °C (308 K to 1273 K) are also possible, however, below 100 °C (373 K) measurement time increases. Argon gas inside the sample chamber enhances heat flow with the sample.

The sample zone chamber is lined with a heat-resistant and intrinsically non-magnetic material. The provided sample holder is a quartz tube sample rod attached to a boron-nitride sample cup. To accommodate the oven within the magnet, ExactGAP index 5 is required. A mechanical vacuum pump capable of maintaining inlet pressures down to 0.67 Pa (5×10^{-3} Torr) must be supplied by the user.

The efficient thermal insulation consists of an evacuation outer chamber with multiple reflective heat shields. Sample zone temperatures as high as 1000 °C are attained with a power consumption of approximately 70 W. Two results of the low power consumption are minimal magnetic interference and increased temperature uniformity in the sample zone. The oven is particularly well suited to measuring Curie temperatures of ferromagnetic or ferrimagnetic materials at temperatures up to 1000 °C. The sensitivity of the VSM permits Curie temperature determinations at relatively low field intensities, allowing more inherently accurate determinations.

At room temperature and above, measurements may be performed in an argon atmosphere to protect the sample from oxidation.

Included with the 8610-OVEN:

1. Oven assembly with mount
2. Nickel Curie sample cylinder
3. Instrument cables and related accessories
4. Sample rods and holders

Supplemental 8610-OVEN equipment requirements:

1. Lake Shore 8610-VTA temperature option kit
2. A mechanical vacuum pump (Lake Shore E2M or similar) capable of achieving a blanked-off pressure below 0.67 Pa (5×10^{-3} Torr) and a pumping speed of 1 m³/h, with a KF-16 flange pump inlet
3. Argon gas cylinder with 5 to 10 psi regulator and 3 mm (1/8 in) hose barb

86/8610-VTA TEMPERATURE OPTION KIT



The autotuning cryogenic temperature controller is used to measure and control our full suite of variable temperature options. The 86-VTA (for the 8604 or 8607) includes a Lake Shore temperature controller, thermocouple input card (when purchased for use with the high temperature oven or single stage variable temperature assembly), GlideLOCK alignment system mount, vacuum handling kit, mounting hardware, flanges, hoses, connectors, and accessories. The 8610-VTA includes a Lake Shore temperature controller, thermocouple input card (when purchased for use with the high temperature oven), vacuum handling kit, mounting hardware, flanges, hoses, connectors, and accessories. Note: only one 86/8610-VTA is required for all variable temperature options.

705 GAS CONTROLLER

The 705 gas controller was specifically designed to automate the gas handling for the 8604 or 8607 temperature options. The 705 operation is controlled by the 8600 Series software and allows the user to have unattended operation from 4.2 K to 1,273 K. In addition, when used in conjunction with the TPS-FRG turbomolecular pump, the 8600 system also monitors the vacuum space surrounding each temperature option to ensure insulation.

86-VEC

The vector option extends the measurement capabilities of the 8604 or 8607 to facilitate investigations of anisotropic magnetic materials, allowing you to determine their vector magnetization components and susceptibility tensor. When used in combination with autorotation, the vector coils provide information that is essentially identical to that provided by a dedicated torque magnetometer. The vector coils mount directly to the 86-VTA option for use with all temperature options or can be mounted to the 86-VEC-MOUNT (sold separately) for room temperature measurements.

86-VEC-MOUNT

The vector option mount is used to mount the vector coils in the magnetic gap of the 8604 or 8607 when room temperature measurements are desired. For measurements in conjunction with a temperature option, the vector coils mount directly to the 86-VTA.

CPW HOLDER FOR NANOSC FMR INTEGRATION

Our FMR-CPW-U-KIT enables use of a [NanOsc PhaseFMR](#) or [PhaseFMR-40 spectrometer](#) with the 8604 or 8607 for ferromagnetic resonance (FMR) measurements. It provides hardware and software integration of NanOsc instruments and U-type CPW sample holder products in a room temperature application*. With it installed, 2 to 18 GHz (PhaseFMR) or 2 to 40 GHz (PhaseFMR-40) FMR measurements in variable DC magnetic fields are possible. Maximum fields depend on the VSM and whether in-plane (IP) or out-of-plane (OOP) orientation is used: 1.54 T IP/1.96 T OOP for the 8604 system; 2.23 T IP/2.55 T OOP for the 8607 system. For details, read our [application note](#).

* Does not include NanOsc CPW, Helmholtz coils, cables, and FMR instruments. These NanOsc room temperature FMR products are available from Quantum Design, our preferred source of NanOsc products.

TPS-FRG TURBOMOLECULAR VACUUM PUMP STATION

Used to annually evacuate the cryogen transfer line of the optional cryostat and single stage variable temperature assembly (transfer line and kit are included with these options), the TPS-FRG provides vacuum to 1.33×10^{-3} Pa (10^{-6} Torr). In addition to annual cryogen transfer line maintenance, the turbomolecular vacuum pump can also be used in place of the E2M rotary vacuum pump for evacuating the cryostat vacuum space.

RECIRCULATING CHILLERS

Lake Shore offers NesLab® recirculating chillers in order to provide a complete laboratory solution. The NesLab chillers feature a CFC-free refrigeration system.

The refrigeration system uses a hermetically sealed compressor and hot gas bypass system of temperature control. This system eliminates on/off cycling and premature wear of the compressor. Strong pumps provide continuous flow even through cooling lines with small IDs.

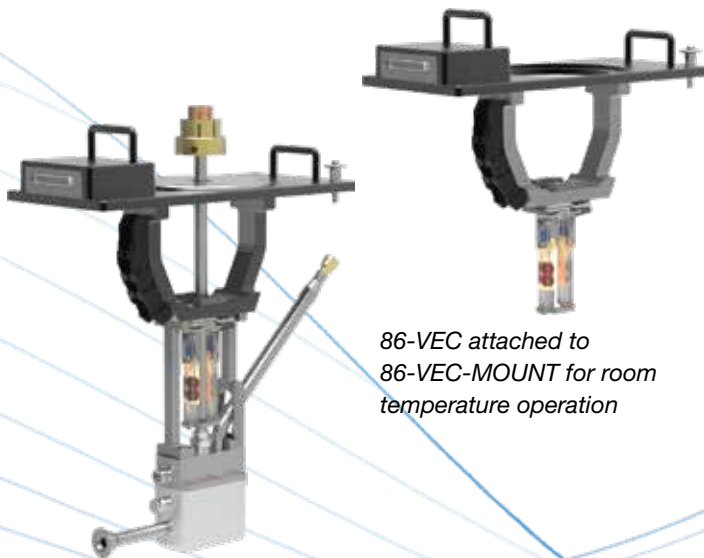

86-VEC attached to SSVT option

86-VEC attached to 86-VEC-MOUNT for room temperature operation

QUICKLIGN™ SAMPLE RODS AND HOLDERS

Use sample rods and corresponding sample holders, or choose one of the integrated rod/holders to meet your application needs.

ROOM TEMPERATURE AND CRYOGENIC APPLICATION SAMPLE RODS AND HOLDERS

86-SR-0935A CARBON FIBER SAMPLE ROD WITH KEL-F THREAD (8604/8607)

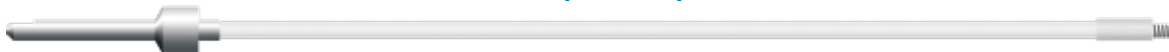

8610-SR-0935 CARBON FIBER SAMPLE ROD WITH KEL-F THREAD (8610)



SAMPLE HOLDERS FOR 86-SR-0935A/8610-SR-0935

Sample holder	Sample orientation	Holder material	Minimum ExactGAP™ index
730931	Powder disposable cup	Kel-F®	2 (8 mm)
730933	Thin film side mount	Kel-F®	
730934	Thin film bottom mount	Kel-F®	
730935	Liquid disposable cup	Kel-F®	
86-SH-0840	Gel cap straw mount	Kel-F®	
86-SH-0841	Disposable gel caps and straws (1000 count)*	Gelatin	

*Room temperature use only

730931 Kel-F powder disposable cup



730933 Kel-F side mount

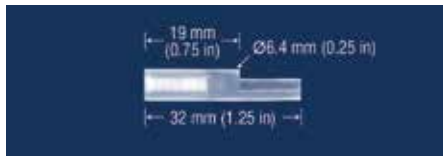

730934 Kel-F bottom mount

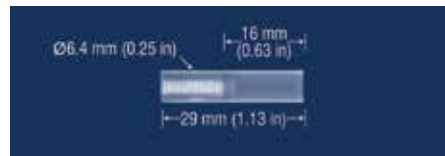

730935 Kel-F liquid disposable cup

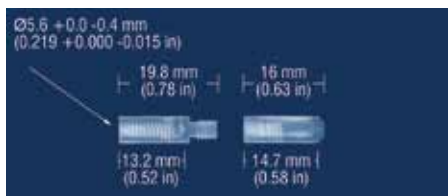

86-SH-0840 gel cap straw mounts

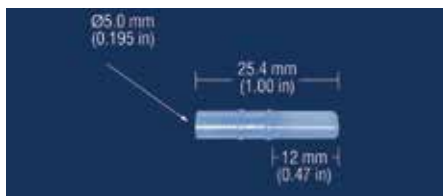

86-SH-0841 disposable gel caps and straws



HIGH TEMPERATURE APPLICATION SAMPLE RODS AND HOLDERS

86-SR-0932 QUARTZ SAMPLE ROD WITH BN THREAD (8604/8607)

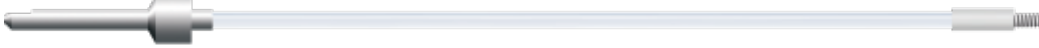

8610-SR-0932 QUARTZ SAMPLE ROD WITH BN THREAD (8610)



SAMPLE HOLDERS FOR 86-SR-0932/8610-SR-0932

Sample holder	Sample orientation	Holder material	ExactGAP™ index
730937	Disposable BN cup	BN	OVEN—5 (6.4 mm) SSVT—3 (6.4 mm)
730938	Thin film side mount	BN	
730939	Thin film bottom mount	BN	

730937 disposable BN cup



730938 BN side mount

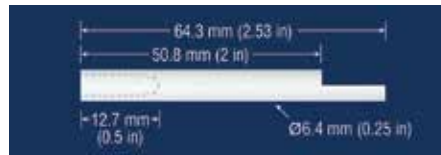

730939 BN bottom mount



SINGLE PIECE INTEGRATED SAMPLE RODS/HOLDERS (8604/8607) FOR ROOM TEMPERATURE AND CRYOGENIC APPLICATIONS

Integrated sample rod/holder	Sample orientation	Material	Gap	Minimum ExactGAP™ index
86-IS-0930	Bottom mount	Quartz	Standard gap	2 (8 mm)
86-IS-0931	Side mount	Quartz	Standard gap	2 (8 mm)
86-IS-0937	Side mount	Quartz	Small gap	1 (3.5 mm)
86-IS-0938	Bottom mount	Quartz	Small gap	1 (3.5 mm)

86-IS-0930 quartz bottom mount



86-IS-0931 quartz side mount



86-IS-0937 quartz small gap side mount



86-IS-0938 quartz small gap bottom mount



SAMPLE ASSEMBLIES INCLUDED WITH BASE SYSTEM AND OPTIONS (8604/8607)

	Sample holders							Sample rods		Single piece integrated sample rod/holder			
	730931	730933	730934	730935	730937	730938	730939	86-SR-0932	86-SR-0935A	86-IS-0930	86-IS-0931	86-IS-0937	86-IS-0938
	Kel-F powder disposable cup	Kel-F thin film side mount	Kel-F thin film bottom mount	Kel-F liquid disposable cup	Disposable BN cup	BN thin film side mount	BN thin film bottom mount	Quartz sample rod, BN thread	Carbon fiber sample rod, Kel-F thread	Quartz bottom mount	Quartz side mount	Quartz side mount (small gap)	Quartz bottom mount (small gap)
Base system	3	3	3	1					1			1	1
With cryostat										1	1		
With oven					1	1	1	1		1	1		
With SSVT					1	1	1	1		1	1		

SINGLE PIECE INTEGRATED SAMPLE RODS/HOLDERS (8610) FOR ROOM TEMPERATURE AND CRYOGENIC APPLICATIONS

Integrated sample rod/holder	Sample orientation	Material	Gap	Minimum ExactGAP™ index
8610-IS-0930	Bottom mount	Quartz	Standard gap	2 (8 mm)
8610-IS-0931	Side mount	Quartz	Standard gap	2 (8 mm)
8610-IS-0937	Side mount	Quartz	Small gap	1 (3.5 mm)
8610-IS-0938	Bottom mount	Quartz	Small gap	1 (3.5 mm)

8610-IS-0930 quartz bottom mount



8610-IS-0931 quartz side mount



8610-IS-0937 quartz small gap side mount



8610-IS-0938 quartz small gap bottom mount



SAMPLE ASSEMBLIES INCLUDED WITH BASE SYSTEM AND OPTIONS (8610)

	Sample holders							Sample rods		Single piece integrated sample rod/holder			
	730931	730933	730934	730935	730937	730938	730939	8610-SR-0932	8610-SR-0935	8610-IS-0930	8610-IS-0931	8610-IS-0937	8610-IS-0938
	Kel-F powder disposable cup	Kel-F thin film side mount	Kel-F thin film bottom mount	Kel-F liquid disposable cup	Disposable BN cup	BN thin film side mount	BN thin film bottom mount	Quartz sample rod, BN thread	Carbon fiber sample rod, Kel-F thread	Quartz bottom mount	Quartz side mount	Quartz side mount (small gap)	Quartz bottom mount (small gap)
Base system	3	3	3	1					1			1	1
With cryostat										1	1		
With oven					1	1	1	1		1	1		

8604 AND 8607 SHIPPING DIMENSIONS (W × D × H) AND WEIGHT

Weights/sizes are approximate. Actual weight and size will vary with system configuration.

	Model 8604	Model 8607
Instrument console, electronics, and computer	122 cm × 91 cm × 132 cm (48 in × 36 in × 52 in) 263 kg (580 lb)	122 cm × 91 cm × 132 cm (48 in × 36 in × 52 in) 222 kg (490 lb)
Electromagnet, magnet base, and frame	122 cm × 91 cm × 132 cm (48 in × 36 in × 52 in) 538 kg (1187 lb)	130 cm × 132 cm × 135 cm (51 in × 52 in × 53 in) 841 kg (1854 lb)
Head	76 × 66 × 117 cm (30 × 26 × 46 in) 84 kg (185 lb)	94 × 76 × 122 cm (37 × 30 × 48 in) 91 kg (201 lb)
Power supply	(Included in instrument console)	91 cm × 117 cm × 122 cm (36 in × 46 in × 48 in) 281 kg (620 lb)

8604 AND 8607 INSTALLATION DIMENSIONS (W × D × H) AND WEIGHT

Weights/sizes are approximate. Actual weight and size will vary with system configuration.

	Model 8604	Model 8607
Instrument console, electronics, and computer	79 cm × 77 cm × 160 cm (31 in × 30 in × 63 in) 183 kg (403 lb)	79 cm × 77 cm × 160 cm (31 in × 30 in × 63 in) 109 kg (240 lb)
Electromagnet, electromagnet base, head, and frame	102 cm × 104 cm × 140 cm (40 in × 41 in × 55 in) 429 kg (945 lb)	102 cm × 104 cm × 140 cm (40 in × 41 in × 55 in) 837 kg (1845 lb)
Power supply	(Included in instrument console)	58 cm × 71 cm × 107 cm (23 in × 28 in × 42 in) 225 kg (495 lb)

8610 SHIPPING DIMENSIONS (W × D × H) AND WEIGHT

Weights/sizes are approximate. Actual weight and size will vary with system configuration.

	Model 8610
Instrument console, electronics, and computer	122 cm × 91 cm × 132 cm (48 in × 36 in × 52 in) 222 kg (490 lb)
Electromagnet	107 cm × 107 cm × 114 cm (42 in × 42 in × 45 in) 1928 kg (4250 lb)
Electromagnet base	112 cm × 112 cm × 43 cm (44 in × 44 in × 17 in) 176 kg (388 lb)
Isolation frame	122 cm × 91 cm × 132 cm (48 in × 36 in × 52 in) 127 kg (279 lb)
Head	91 × 66 × 91 cm (36 × 26 × 36 in) 77 kg (170 lb)
Power supply	122 cm × 91 cm × 132 cm (48 in × 36 in × 52 in) 332 kg (732 lb)

8610 INSTALLATION DIMENSIONS (W × D × H) AND WEIGHT

Weights/sizes are approximate. Actual weight and size will vary with system configuration.

	Model 8610
Instrument console, electronics, and computer	79 cm × 77 cm × 160 cm (31 in × 30 in × 63 in) 109 kg (240 lb)
Electromagnet, electromagnet base, head, and frame	102 cm × 117 cm × 137 cm (40 in × 46 in × 54 in) 1950 kg (4300 lb)
Power supply	58 cm × 71 cm × 107 cm (23 in × 28 in × 42 in) 225 kg (495 lb)

SITE REQUIREMENTS

A system-specific site prep checklist will be provided

POWER

Instrumentation, computer, and optional vacuum pump require two standard single-phase electrical outlets (20 A maximum). Magnet power supply and optional recirculation chiller require 3-phase electrical outlets (21 A maximum).

WATER

Electromagnet requires one supply and one return line for cooling with up to 15 L/min and 30 to 50 psi. Magnet power supply requires a minimum of 7.6 L/min with a maximum pressure of 80 psi and +15 °C to +30 °C water temperature.

FLOOR

The floor must support the weight of the magnet, supply, and the equipment used to move them into place. The weight of the console is negligible in comparison. Heavy concrete ground floors usually prove best, not only because they have the required strength, but such a floor also transmits minimal building vibration to the magnetometer.

The system also requires minimum spacing between each of the above three pieces and 0.75 m for access to the rear of the equipment. (See Installation Dimensions and Weight table.)

ENVIRONMENT

The VSM requires a temperature-controlled environment that is relatively free of airborne dust and debris. There should be no equipment placed next to the VSM system that would emit or be susceptible to high levels of magnetic interference (distribution boxes, vibration equipment, x-ray machines, etc.)

ORDERING INFORMATION

8600 Series systems

8604	Advanced performance VSM with 4 in electromagnet, Gen2 head, Model 737 controller, system console, Model 643 power supply, and software
8607	Advanced performance VSM with 7 in electromagnet, Gen2 head, Model 737 controller, system console, Model 648 power supply, and software
8610	Advanced performance VSM with 10 in electromagnet, Gen2 head, Model 737 controller, system console, Model 648 power supply, and software
VSM-TRAINING	2 days on-site VSM operational training/verification—price includes travel time and expenses; *1 additional operational training/verification day required for each and every temperature option
VSM-TRAINING-1	Additional VSM operational training/verification days

7400 Series upgrades

Consult Lake Shore for information on upgrading your 7400 Series VSM to the 8600 Series

Options

EMP-HF	MeasureReady EMP high field pole cap option
86-CRYO	8600 Series LN ₂ /LHe cryostat option for use with 8604/8607 (included as standard equipment on the 8610). Temperature operating range is LN ₂ operation 77 K (flooded), 85 K to 420 K control range; LHe operation 4.2 K (flooded), 5.5 K to 420 K control range. Used with the GlideLOCK alignment system. Includes wall mount storage bracket. Requires 86-VTA and TPS-FRG turbomolecular pump (must be ordered separately). Supplemental requirements are LN ₂ Dewar (1220-50 or equivalent) or LHe Dewar and LN ₂ or LHe gas cylinder and regulator.
8610-CRYO	8600 Series LN ₂ /LHe cryostat option for use with 8610. Temperature operating range is LN ₂ operation 77 K (flooded), 85 K to 420 K control range; LHe operation 4.2 K (flooded), 5.5 K to 420 K control range. Compatible with EM10 mounting system. Includes wall mount storage bracket. Requires 8610-VTA and TPS-FRG turbomolecular pump (must be ordered separately). Supplemental requirements are LN ₂ Dewar (1220-50 or equivalent) or LHe Dewar (1230-60 or equivalent) and LN ₂ or LHe gas cylinder and regulator.
86-OVEN	8600 Series high temperature oven option for use with 8604/8607. Temperature operating range is room temperature to 1273 K. Used with the GlideLOCK alignment system. Includes wall mount storage bracket. Requires 86-VTA (must be ordered separately). Optional Model 705 gas controller is compatible and automates argon flow. Supplemental equipment requirements are argon gas cylinder with regulator, and vacuum pump with blankoff pressure of 5×10^{-3} Torr.
8610-OVEN	8600 Series high temperature oven option for use with 8610. Temperature operating range is 308 K to 1273 K. Compatible with EM10 mounting system. Includes wall mount storage bracket. Requires 8610-VTA (must be ordered separately). Supplemental equipment requirements are argon gas cylinder with regulator and vacuum pump with blank-off pressure of 5×10^{-3} Torr.
86-SSVT	8600 Series single stage variable temperature option for use with 8604/8607. Temperature operating range is 77 K (flooded), 100 K to 950 K control range. Compatible with the GlideLOCK alignment system. Includes wall mount storage bracket. Requires 86-VTA, 705 gas controller, and TPS-FRG turbomolecular pump (must be ordered separately). Supplemental equipment requirements are argon gas cylinder with 50 psi gas regulator, nitrogen gas cylinder with 50 psi gas regulator, an LN ₂ source to fill the provided 25 L LN ₂ Dewar, and clean compressed air (40 psi).
86-VTA	8600 Series variable temperature control option with Model 336 for use with 8604/8607. Option kit contains temperature controller and thermocouple card, GlideLOCK option mount, flanges, hoses, connectors, and accessories.
8610-VTA	8600 Series variable temperature control option with Model 336 for use with 8610. Option kit contains temperature controller and thermocouple card, EM10 option mount, flanges, hoses, connectors, and accessories.
705	The Model 705 gas controller, for use with 8604/8607, automates the 86-SSVT and 86-OVEN gas handling operation. The 705 operation is controlled by the 8600 Series software and allows the user to have unattended operation on the 86-SSVT option from 100 K to 950 K and optimizes the gas handling functions in conjunction with the 86-OVEN option.
86-VEC	Vector coil option for use with 8604/8607. Mounts directly to the 86-VTA option for use with all temperature options or can be mounted to the 86-VEC-MOUNT (sold separately) for room temperature measurements.
86-VEC-MOUNT	8604/8607 vector option mount for room temperature measurements.
FMR-CPW-U-KIT	CPW holder for NanOsc FMR for use with MCS-EMP and 8600 Series VSM systems

ORDERING INFORMATION

Sample rods and integrated rod/holders for the 8604/8607

86-IS-0930	Sample rod, quartz with integrated thin film bottom mount, required sample access is 8 mm (ExactGAP™ index 2)
86-IS-0931	Sample rod, quartz with integrated thin film side mount, required sample access is 8 mm (ExactGAP™ index 2)
86-SR-0932	Sample rod, quartz rod only—requires separate sample holder, required sample access is 8 mm (ExactGAP™ index 2)
86-SR-0935A	Sample rod, carbon fiber rod only—requires separate sample holder, required sample access is 8 mm (ExactGAP™ index 2)
86-IS-0937	Sample rod, quartz with integrated thin film side mount, required sample access is 3.5 mm (ExactGAP™ index 1)
86-IS-0938	Sample rod, quartz with integrated thin film bottom mount, required sample access is 3.5 mm (ExactGAP™ index 1)

Sample rods and integrated rod/holders for the 8610

8610-IS-0930	Sample rod, quartz with integrated thin film bottom mount, required sample access is 8 mm (magnet index 2)
8610-IS-0931	Sample rod, quartz with integrated thin film side mount, required sample access is 8 mm (magnet index 2)
8610-SR-0932	Sample rod, quartz rod only—requires separate sample holder, required sample access is 8 mm (magnet index 2)
8610-SR-0935	Sample rod, carbon fiber, rod only—requires separate sample holder, required sample access is 8 mm (magnet index 2)
8610-IS-0937	Sample rod, quartz with integrated thin film side mount, required sample access is 3.5 mm (magnet index 1)
8610-IS-0938	Sample rod, quartz with integrated thin film bottom mount, required sample access is 3.5 mm (magnet index 1)

8600 Series sample holders

730931	Sample holder, 2-piece cup, Kel-F®, upper and lower portion, required sample access is 8 mm (magnet index 2)
730933	Sample holder, thin film side mount, Kel-F®, required sample access is 8 mm (magnet index 2)
730934	Sample holder, thin film bottom mount, Kel-F®, required sample access is 8 mm (magnet index 2)
730935	Sample holder, liquid, upper and bottom portion, Kel-F®, required sample access is 8 mm (magnet index 2)
730937	Sample holder, 2-piece cup, boron nitride, required sample access is 8 mm (magnet index 2)
730938	Sample holder, thin film side mount, boron nitride, required sample access is 8 mm (magnet index 2)
730939	Sample holder, thin film bottom mount, boron nitride, required sample access is 8 mm (magnet index 2)
86-SH-0840	Sample holder, gel cap straw mount (room temperature only), required sample access is 8 mm (magnet index 2)
86-SH-0841	Sample holder, disposable gel cap with straw, 1000 quantity (room temperature only), required sample access is 8 mm (magnet index 2)

8600 Series accessories

730907	2.4 mm diameter test sample sphere, NIST-traceable, 3.47 emu
730908	Nominal 3 mm diameter test sample, 99% pure nickel sphere, 6.92 emu—standard with all 8600 Series systems (for daily VSM use)
730909	Nominal 1 mm diameter test sample, 99% pure nickel, 0.25 emu—standard with all 8600 Series systems (cross-calibrated to the 730908)
86-0910	Cement, high temperature, -200 °C to 843 °C
86-LC	Replacement set of sense coils (one set is included with each system)
86-0911	Replacement Hall probe
TPS-FRG-100/120V	Compact turbo pumping system; includes V-84 turbo pump (NW 40) with oil free dry scroll backing pump, FRG-700 full range gauge, controller, and interface cable to USB port; includes Agilent 24 month warranty NOTE: requires SYS-TP-KIT
TPS-FRG-220/240V-CE	Compact turbo pumping system; includes V-84 turbo pump (NW 40) with oil free dry scroll backing pump, FRG-700 full range gauge, controller, and interface cable to USB port; includes Agilent 24 month warranty NOTE: requires SYS-TP-KIT
SYS-TP-KIT	Includes all components necessary to connect NW 40 turbo pumping system to the vacuum port of any Lake Shore system (except probe stations)
1220-50	50 L LN ₂ Dewar with ½ in top withdraw port and 10 psi pressure relief valve
1230-60	60 L LHe Dewar

Visit www.lakeshore.com for available recirculating chiller models

02/08/2024

Lake Shore Cryotronics, Inc.

575 McCorkle Blvd.
Westerville, OH 43082
Tel 614-891-2244
Fax 614-818-1600
info@lakeshore.com
www.lakeshore.com