

Probe Stations



Supporting advanced research since 1968, Lake Shore (www.lakeshore.com) is a leading innovator in measurement and control solutions for materials characterization under extreme temperature and magnetic field conditions. High-performance product solutions from Lake Shore include cryogenic temperature sensors and instrumentation, magnetic test and measurement systems, probe stations, and precision materials characterizations systems that explore the electronic and magnetic properties of next-generation materials. Lake Shore serves an international base of customers at leading university, government, aerospace, and commercial research institutions and is supported by a global network of sales and service facilities.

Contents

Family overview.....	4–5
Applications overview.....	6
Research examples.....	7
Hall system integration.....	8
THz on-wafer probing.....	2
Unique configurations.....	9
Variable temperature solutions.....	10–11
Accurate sample temperature is key.....	12–13
Systems overview.....	14
Features by model.....	14
Initial cost/cryogen cost comparison.....	15
Probing configurations.....	16–21
Sample holders.....	22–23
Vision system.....	24–25
Installed options.....	26
Field installable options.....	27–29
TTPX.....	30–31
CPX.....	32–33
CPX-VF.....	34–35
EMPX-H2.....	36–37
FWPX.....	38–39
CRX-6.5K.....	40–41
CRX-4K.....	42–43
CRX-VF.....	44–45
CRX-EM-HF.....	46–47
Ordering information.....	48–49
Equipment compatibility.....	50–51
How to configure a probe station.....	52

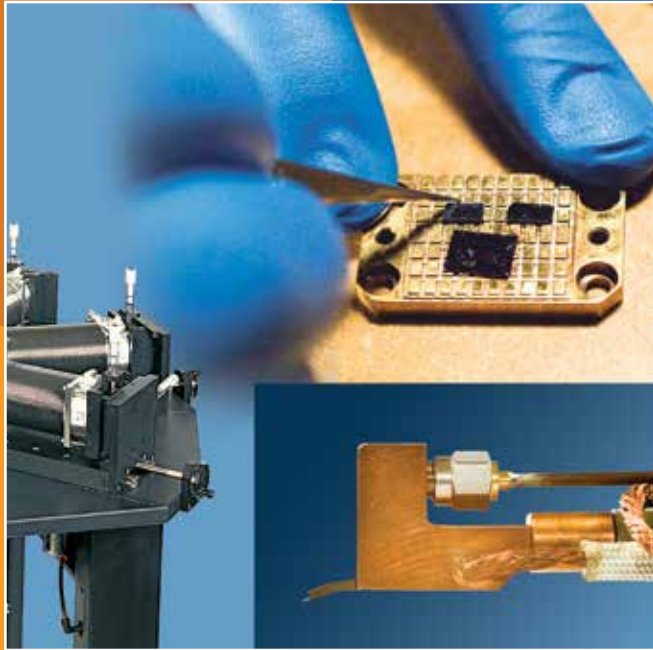

Lake Shore's cryogenic probe stations provide precisely controlled environments for non-destructive measurement of the electrical properties of materials and early-stage electronic devices.

Probe stations enable physical scientists and researchers to conduct fundamental science through convenient, repeatable measurements producing consistent results. Probe stations are versatile and flexible research platforms that can be used in dedicated applications or as multi-use community research assets.

Typical applications include sampling I-V and C-V curves over a wide range of temperatures, measuring microwave and electro-optical responses, characterizing magneto-transport properties in variable magnetic fields, Hall effect measurements to understand carrier mobility, and a variety of other material studies.

Cryogenic Probe Stations



Cryogen-Free Probe Stations



Horizontal Field



Vertical Field

Available with
integrated Hall
measurement



No Field

Selection, precision, versatility

Lake Shore's family of precision cryogenic probe stations offers numerous environmental and probing choices to meet the diverse application needs of researchers. From general purpose units to specialized platforms, each probe station is carefully designed to ensure stable operation and dependable measurements from cryogenic temperatures all the way through the operating range.

Cryogen-free platforms offer customers the convenience of push-button operation, while liquid cryogen-based stations provide a lower initial cost for those who are comfortable working with traditional liquid cryogenes. Magnet-equipped models enable the study of material responses in fields up to as high as ± 2.5 T. Application-specific configurations including high vacuum, load-lock, high temperature, and larger sample sizes are offered on certain models.

All Lake Shore probe stations include unique thermal design features to ensure the highest possible confidence when recording sample temperatures. High-precision micro-manipulated probe stages and a variety of probe tip options ensure accurate tip placement across a wide range of sample types. And, with our patented ZN50R-CVT probe, stable tip position is assured, making convenient unattended measurements possible over continuously variable temperatures.

Need automated or larger-wafer probing?

Contact Lake Shore sales. We can recommend a probe station that supports full-wafer probing and features automated stages for replicating measurements across many wafer devices.

Applications overview

Lake Shore probe stations are well suited for a broad range of material characterization and measurement applications. The table below lists several of these applications and indicates where each probe station is a good fit (orange) or has been specifically designed for this purpose (star).

Cryogenic probe stations

	TTPX	CPX	CPX-VF	EMPX-H2	FWPX
I-V					
C-V					
Microwave		★	★		★
Electro-optical	★				
Magneto-transport (MT)			★	★	
Vector dependent MT				★	
Hall effect measurement	**	**	★		
Organics		★	★		
Controlled sample transport		★	★		
Large wafer*					★

Cryogen-free probe stations

	CRX-6.5K	CRX-4K	CRX-VF	CRX-EM-HF
I-V				
C-V				
Microwave				
Electro-optical				
Magneto-transport (MT)			★	★
Vector dependent MT				★
Hall effect measurement	**	**	★	**
Organics	★	★	★	★
Controlled sample transport			★	
Large wafer*				

★ = Recommended for

□ = Is capable of

* For probing wafers larger than 102 mm or 152 mm, contact Lake Shore

** Limited Hall effect measurements possible with 0.2 T ring magnet installed

Applications

Nanoelectronics

Magnetism & spintronics

Organic & molecular electronics

Semiconductors

Optoelectronics

Microwave electronics

Quantum devices

Superconductors

MEMS/NEMS

Low noise RF

Ferroelectrics

Thin films

IR detectors

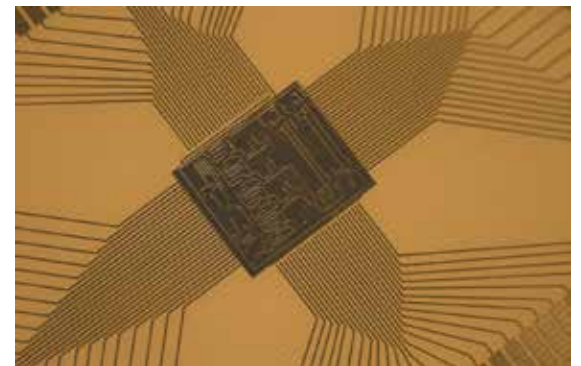
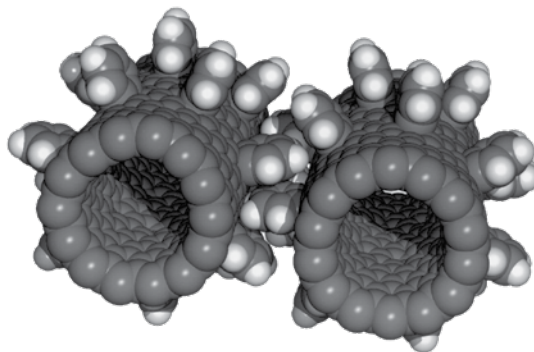
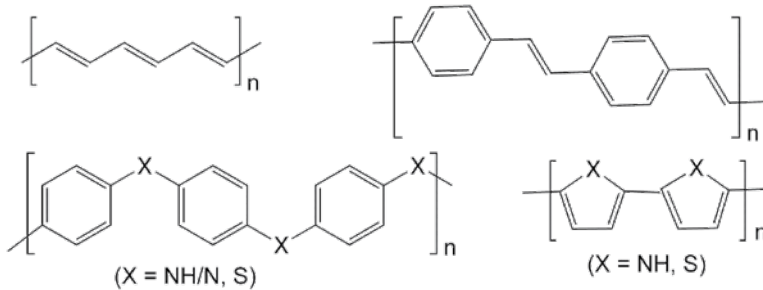

Research examples

Superconducting RF MEMS filter design

A novel superconducting RF MEMS switch is implemented in a capacitor bank to realize different capacitance values. The capacitor bank is monolithically integrated to a shunt bandstop resonator. Figure 1 shows the circuit model of the tunable resonator. The resonator consists of a lumped element spiral inductor in series with a switched capacitor bank. Figure 2 illustrates a picture of the monolithically integrated bandstop resonator with the capacitor bank. The dimension of the device is 2.7 mm × 1.3 mm, which is extremely miniaturized for a high quality factor tunable resonator. The tunable resonator is measured in the Lake Shore cryogenic probe station using two ground-signal-ground (GSG) probes. Figure 3 shows the measured results of the three states of the tunable resonator at 4 K. The resonance frequency is initially at 1.107 GHz when all the switches are off (state I); then shifts to 1.057 GHz and 1.025 GHz when the first and the second switches are on, respectively.

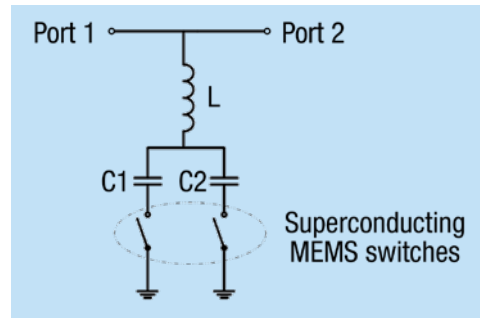

Figure 1

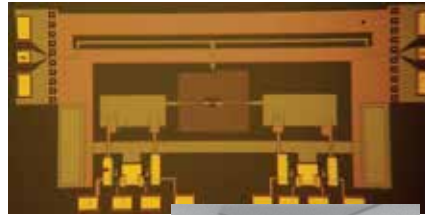

Figure 2

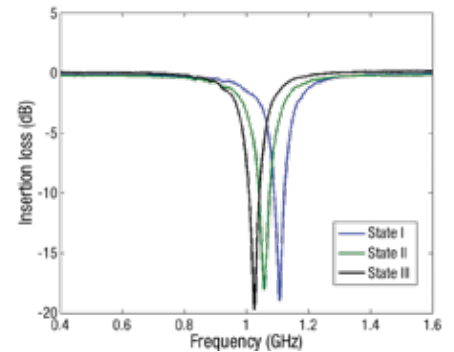
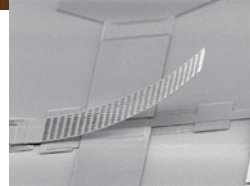

Figure 3

Raafat R. Mansour, Ph.D, Professor
Electrical and Computer Engineering Department
University of Waterloo

DLTS/DLOS to measure defects in semiconductor devices

Deep level transient spectroscopy (DLTS) is a powerful technique to measure defects in semiconductors and interfaces in a variety of devices. For wide bandgap-based devices, deep level optical spectroscopy (DLOS) enables probing deeper than the thermal limit of ~1 eV and probing of traps in the minority carrier half of the bandgap. These techniques are traditionally performed on Schottky or p-n junctions, but can also be applied to metal-insulator-semiconductor capacitors (MISCAPs) to accurately quantify interface state densities throughout the interface bandgap.

Figure 1 shows a typical structure for measuring interface states and Fig. 2 shows the results of the thermal and optical DLTS/DLOS scans of the sample in Fig. 1. The interface states are shown directly correlate with frequency dispersion and can cause a number of performance related issues (leakage pathways, transient threshold voltage shifts, noise, etc.) in typical devices.

The Lake Shore cryogenic stages allow scanning the temperature over a wide range, ideal for DLTS, and provides easy optical access to shine monochromatic light on the samples for DLOS. Customized for our application, the probes allow scanning hundreds of degrees Kelvin without contacts slipping and without destroying delicate contacts (something not possible in many cryogenic stages).

Aaron Arehart, Ph.D, Professor
Electrical and Computer Engineering Department
The Ohio State University

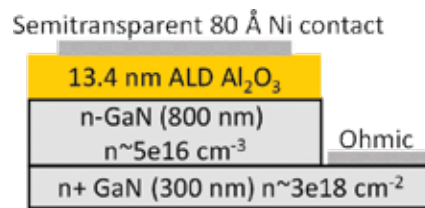

Figure 1: Metal-insulator-semiconductor structure for analyzing interface state densities at the insulator-semiconductor interface, specifically the atomic layer deposition (ALD)-grown Al_2O_3 /n-type NH_3 -MBE-grown GaN interface is quantified using deep level transient and optical spectroscopies (DLTS/DLOS).

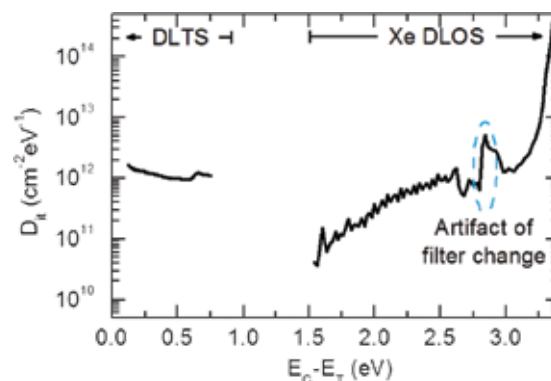

Figure 2: Interface state density (D_{it}) at the ALD Al_2O_3 /GaN interface in Figure 1 is shown using thermally-based DLTS for states within 0.8 eV of the GaN conduction band and optically stimulated emission-based DLOS using a xenon (Xe) lamp for mid-gap to GaN valence band.

Order a CRX-VF station with an integrated Hall measurement system



Typical Hall contacts eliminated by CRX-VF

For non-destructive Hall measurement of wafer-scale materials in a tightly controlled probing environment

The Lake Shore PS-HM-8425 package enables you to add all of the DC Hall measurement capabilities of our 8400 Series Hall system to your CRX-VF probe station.

The package includes all the instrumentation and data acquisition/analysis software for performing Hall voltage, Hall coefficient, Hall mobility, resistance, I-V curve, and other measurements. Use the system to identify carriers of

materials by their excitation energies and gain an understanding of dominating mechanisms, whether for Hall bar geometries or for performing gated Hall bar measurements.

The system is ideal for measuring multilayer Hall structures as part of device development as well as probing minute Hall structures that are prone to contamination, reactive to air, or might require initial warming to drive out moisture. And because probes are used for Hall measurements, there is no need to attach wires to the sample (as required in a conventional Hall measurement system). Also, you can probe full or partial wafers up to 51 mm (2 in) in diameter, eliminating the need to dice fabricated wafers.

For more information, see page 44.

To see more specifications and other details, go to www.lakeshore.com.



Direct and derived measurements as a function of field and temperature

Hall voltage

I-V curve measurements

Resistance

Magnetoresistance

Magnetotransport

Hall coefficient

Hall mobility

Anomalous Hall effect (AHE)

Carrier type/concentration/density

Van der Pauw and Hall bar structures



NEW M81-SSM Source Measure System

Timing is everything. Now it's automatic.



An innovative instrument architecture optimized to provide synchronous DC, AC, and mixed DC+AC source and measure to 100 kHz for low-level measurements

The MeasureReady™ M81-SSM (Synchronous Source and Measure) system provides a confident and straightforward approach for advanced measurement applications. The M81 is designed to eliminate the complexity of multiple function-specific instrumentation setups, combining the convenience of DC and AC sourcing with DC and AC measurement, including a lock-in's sensitivity and measurement performance.

This extremely low-noise simultaneous source and measure system ensures inherently synchronized measurements from 1 to 3 source channels and from 1 to 3 measure channels per half-rack instrument—while also being highly adaptable for a range of material and device research applications.

Learn more at www.lakeshore.com/m81



Unique real-time sampling architecture for synchronous sourcing and measuring



Ideal for scientific-grade low-level measurement applications



The absolute precision of DC plus the detection sensitivity performance of AC instrumentation



Remote-mountable modules are interchangeable between instruments

Unique configurations possible

Thanks to Elliot Scientific in the U.K., for calling this to our attention: an interesting Lake Shore CRX probe station configuration, one that has a spectrophotometer integrated into its design. This customized probe station, installed at the University of Southampton's Centre for Photonic Metamaterials, features an integrated CRAIC Technologies InGaAs Spectrophotometer and Zeiss microscope. In this setup, researchers are able to observe optical properties of nanostructured materials at cryogenic temperatures. Elliot Scientific, who is quite knowledgeable of both Lake Shore and CRAIC products, was able to offset mount a Zeiss microscope carrying the spectrophotometer onto the probe station. A dished lid was added to allow the station's use with the spectrophotometer, and the microscope uses a custom-manufactured rig to provide smooth movement in three axes above the sample chamber. The probe station offers conventional top-side illumination down the axis of the microscope, but for this setup, the station was also adapted to provide sample illumination from the side, with the light then directed upward using a 45° mirror under the sample holder to provide illumination to the back of the sample.

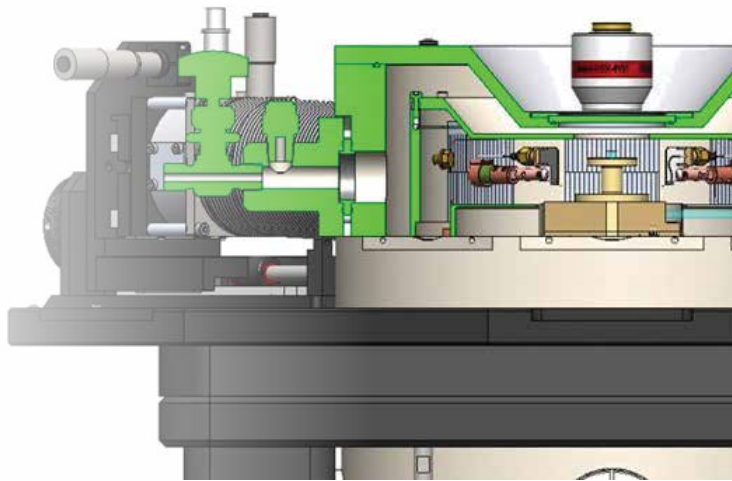

For more information about what Lake Shore and our international representatives can do to help you outfit a probe station for a specialized application, please contact us at sales@lakeshore.com.

Lake Shore probe stations can be adapted in other ways, too. Custom configurations have been provided for:

- A CRX-EM-HF built to allow for the mounting of a pivoting and articulating microscope-based system analyzer head at the top for the visualization and analysis of micro structures; this design necessitated the use of a dished lid and custom radiation shield assembly to reduce Z-axis travel.
- A CRX-VF probe station adapted to allow for the connection of a load-lock arm to a deposition system, a design that allows the user to mechanically move a sample from the deposition system to the station and back without breaking vacuum.
- A CPX probe station with a modified load lock sample transfer chamber that enables university researchers to easily move sensitive wafer samples from an inert gas glovebox via the sample-transfer "suitcase" to the station's chamber without exposing them to the air. See page 26 for the suitcase option.

Software solutions for variable temperature measurements

Using a Keysight B1500A semiconductor device parameter analyzer to automate measurements



Keysight B1500A

Reliable measurements in less time. It's what every material researcher strives for. Now precise characterization of early-stage materials and devices over wide temperature ranges is made even more convenient—thanks to a collaboration between Keysight Technologies and Lake Shore Cryotronics that links our respective products.

An interface to Lake Shore probe stations' cryogenic temperature controller (Model 336) enables researchers using Keysight's powerful B1500A semiconductor device parameter analyzer and its EasyExpert™ software to programmatically manage temperature settings while making automated measurements.

With the B1500A analyzer connected to a Lake Shore cryogenic probe station, you can efficiently probe early-stage devices and materials, then you can initiate the software to run a diverse set of parameter measurements over a range of temperatures while you attend to other matters. EasyExpert takes care of the measurements and coordinates seamlessly with the Model 336 to precisely record and control sample temperatures throughout the run.

Convenient operation, reliable measurements, more productivity. Take control of your research with this integrated solution from Keysight and Lake Shore.



Using a Keithley 4200-SCS parameter analyzer to automate measurements

Many Lake Shore customers use stand-alone instrumentation and automation software to control probe station measurements. But we're also seeing others using the integrated programming interface of Keithley's 4200-SCS Parameter Analyzer system to automate the running of variable temperature measurements in a Lake Shore probe station with our patented ZN50R-CVT probes.

This can be quite a time-saver, especially when measuring I-V curves or sheet resistance at various temperatures. Instead of having to set the sample stage temperature, wait for the sample temperature to stabilize, and perform one or more device measurements before moving on to the next temperature, you can program the system to step through temperature settings and run a number of measurements over a range of temperatures without repeated user intervention.

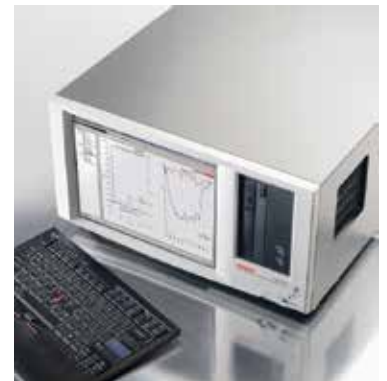

Keithley 4200-SCS

This programmatic capability is integrated into the 4200-SCS system because Keithley's latest firmware release includes a driver for the Lake Shore Model 336, the instrument that controls the probe station sample stage temperature. It can be particularly helpful, for example, when characterizing transistor devices at various temperatures.

1. 336 initialization
2. Sets temperature and reads stage temperature until it reaches setpoint
3. Performs device measurement

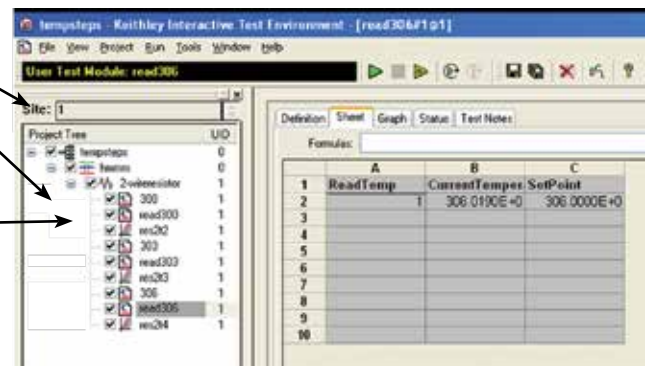

Using a Radiant system to rapidly characterize ferroelectric devices

Ferroelectric materials are used in a wide variety of applications, including sensors, ferroelectric memory (FeRAM), MEMs devices, actuators, and photovoltaics. Rapid assessment of ferroelectric device characteristics is critical to improving ferroelectric materials processing as well as developing accurate ferroelectric device models. The combination of Radiant ferroelectric test solutions and Lake Shore probe stations offers researchers a flexible platform to efficiently characterize multiple devices in a cryogenic probing environment. The addition of cryogenic temperature characterization can open new frontiers to understanding dielectric properties, switching mechanisms, and fatigue in ferroelectric materials.



Measurements include:

- Hysteresis vs. temperature
- Leakage vs. temperature
- Hysteresis speed vs. temperature
- Remanent hysteresis vs. temperature
- PUND remanent polarization vs. temperature
- PUND frequency response vs. temperature
- Breakdown voltage vs. temperature
- I-V vs. temperature
- C-V vs. temperature
- Fatigue vs. temperature
- Retention vs. temperature
- Imprint vs. temperature

Probing environment

Lake Shore cryogenic probe stations are versatile and flexible research platforms which provide precisely controlled environments for non-destructive measurement of the electrical properties of materials and electronic devices. When combined with Lake Shore's patented continuously variable temperature (CVT) probes, true unattended wafer probing of a device across a range of temperatures is achieved. The CVT probe design absorbs probe arm movement caused by thermal expansion and contraction, resulting in a stable probe tip landing position throughout variable temperature cycling.

Easy interface

Lake Shore probe stations easily interface with Radiant Technologies, Inc. Ferroelectric/Multiferroic Test Systems to provide fast and accurate testing of ferroelectric and piezoelectric materials as a function of temperature.

Easy programming

Radiant's data acquisition program executes automated tests of single samples over a wide temperature range, making long duration testing effortless.

Combined with a Lake Shore probe station and Model 336 controller, temperature setpoints can be pre-programmed. The software can be configured for different measurements and generate multiple plots at the touch of a button. These plots (in a single pass on a single sample) include but are not limited to:

- Measure and plot hysteresis
- Remanent polarization
- Leakage
- Small signal capacitance
- Thermally engineer ferroelectric components
- Set variable temperature measurements
- Measure phase boundaries
- Measure coercive voltage changes
- Measure switching speeds
- Measure device leakage

Contact us so we can configure the right probe station and precision test platform for your application—supplied jointly with Radiant.

Remanent Hysteresis 10 K to over 310 K
[AB403, 100 μs]

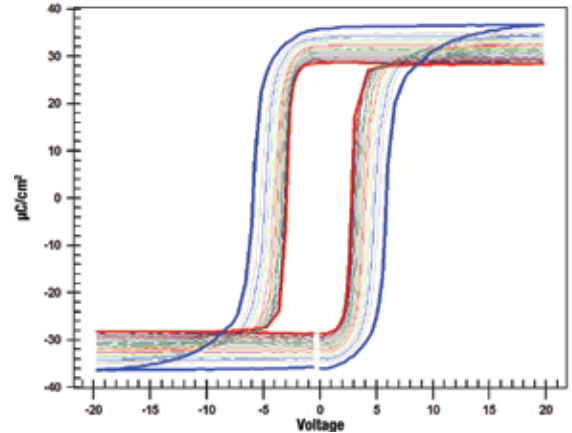

Remanent hysteresis vs. temperature—40,000 μm² 20/80 PZT measured in a Lake Shore CRX-4K probe station

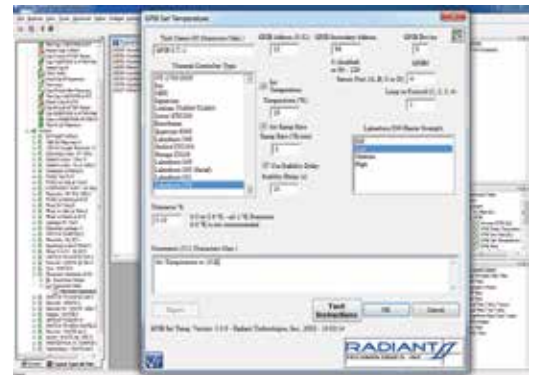

Vision™ data acquisition software enables plotting of multiple temperature measurements as well as custom programming to create your own test profile

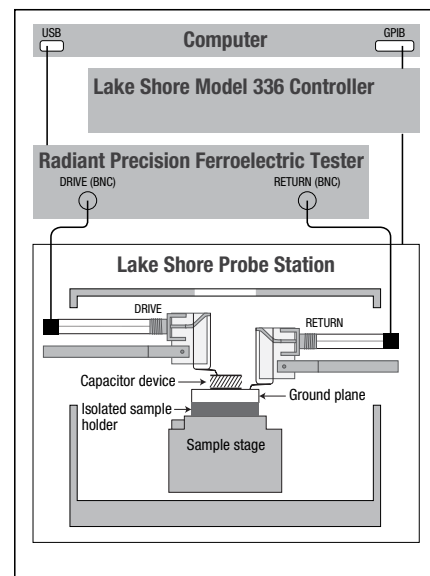

Lake Shore cryogenic chamber and Radiant's test system easily interface. Vision™ software controls the Lake Shore unit via the Lake Shore Model 336 temperature controller.

The accuracy of your sample temperature is key

Cryogenic measurements of devices in conventional cryostats typically require time-consuming and destructive wiring of an on-wafer device. That isn't the case with cryogenic probe stations. These platforms enable visualization and electrical interrogation of multiple wafer-level devices using positionable probes, accelerating characterization efforts. The tradeoff for optical access to and flexible probing of the device under test lies in the heat loads from thermal radiation and probe arm heat conduction via the probe arms. Because of these loads, as well as the thermal resistance between the device and sample stage, the actual temperature of the device can deviate from the sample stage sensor — leading to inaccurate measurements.

To minimize this effect, the probe station should have radiation shields to reduce the thermal radiation on the sample and the probes should be thermally anchored at or near the sample stage (see the next page for how our stations are designed this way). Below, we examine the role of probe arm thermal anchoring in relationship to device temperature, specifically when attempting to quickly evaluate superconducting circuits, a common application for cryogenic measurements of electronic devices.

Determining conductive heat transfer in a probe station using Cernox® and niobium wire reference measurements

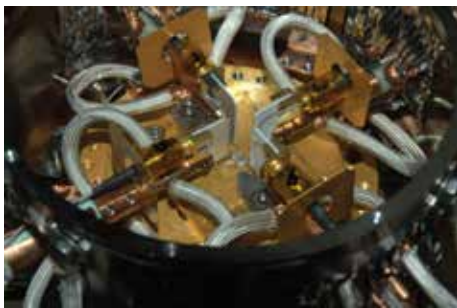

Four point probing of a Cernox reference device using a CRX-4K probe station

Experimental setup

To investigate the role of probe arm thermal anchoring on the device temperature in a cryogenic measurement, a Lake Shore CRX-4K probe station with a fixed 1 W sample stage cooling capacity was chosen as the test platform. For simulating a device under test, a calibrated Cernox® sensor was soldered onto a sapphire substrate, with

its underside coated with a thin layer of Apiezon® N grease and clamped to a 32 mm (1.25 in) grounded sample holder. Tungsten tips (25 µm diameter) on four probe arms were landed on the contact pads of the sensor, and the device temperature was obtained with our Model 336 temperature controller using a four-point probing measurement of sensor resistance. Additional temperature sensors within each of the four arms and one bolted to the underside of the sample stage were used to monitor arm and stage temperatures.

Results

Table 1 summarizes the device, stage, and arm temperatures for three common probe arm thermal anchoring configurations. In the recommended configuration, the arm is anchored to the radiation shield and the probe is anchored to the sample stage (as shown in the diagram on the next page). The second configuration relies solely on thermally anchoring both the arm and the probes to the shield, and the final configuration consists of four unanchored arms and the shielding removed.

Table 1 – Configuration dependent device temperature

Probing configuration	Sample stage temp (K)	Mean arm temp (K)	Device temp (K)
Arms anchored to radiation shield, probes to sample stage	4.87	9.21	7.57
Arms anchored to radiation shield	3.80	34.94	12.13
Arms not anchored, no radiation shield	6.46	271.7	41.16

In the first configuration, the thermal load on the station's cooling stage is increased by anchoring the probes to the sample stage, resulting in a higher sample stage temperature than in the second configuration with the probes anchored to the radiation shield. However, the lower sample stage temperature does not translate into a lower device temperature as the extra

conductive heat load from the probes is not compensated by the additional cooling through the device substrate. Despite the relatively small impact on stage temperature by removing the radiation shield and probe/probe arm thermal anchors, the third configuration causes a substantial increase in heat load to the device, driving up the device temperature by more than 30 K.

Discussion

Using well-anchored probes and probe arms, we demonstrate the ability to rapidly evaluate superconducting circuits. For this measurement, a small wire was cut from a 99.8% pure niobium foil (Alfa-Aesar®) and affixed to a sapphire plate with a thin layer of cyanoacrylate adhesive. The wire was then thinned to increase the contrast in resistance between normal and superconducting states; the thinned niobium wire has a 272 mΩ resistance at room temperature. The sapphire substrate was mounted in an identical fashion to the Cernox reference chip, then cooled to cryogenic temperatures in the station. After landing four probes directly on the niobium wire, the wire resistance was monitored as a function of stage temperature with our Model 370 AC resistance bridge equipped with a 3708 pre-amplifier. At each stage temperature setpoint, the system was allowed to stabilize for 5 min prior to acquiring a device resistance.

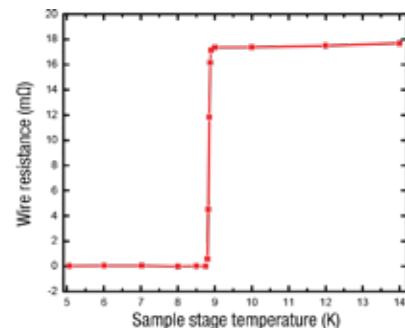

Superconducting transition in a probed niobium wire

The figure at left shows the wire resistance as a function of stage temperature, indicating a sharp decrease in the wire resistance at stage temperatures below 8.90 K, which we attribute to the onset of superconductivity in the probed wire. Below 8.75 K, the wire resistance drops below the measurement accuracy of the experimental setup (<40 µΩ).

Conclusion

By probing a calibrated Cernox sensor and a niobium whisker, we found that conductive heat transfer from the probes can impart a significant thermal load on a device under test, and thermal anchoring is critical for managing the heat transfer and achieving suitable device temperatures. We demonstrated that in a probe station configuration with properly thermally anchored probes and effective radiation shielding, the thermal gradient between device under test and the sample stage can be minimized.

How our stations keep heat from reaching the sample

Lake Shore's probe stations take thermal management to the next level, providing a measurement platform you can really trust.

Thermal probe anchoring Lake Shore probe stations include special thermal anchoring to throttle unwanted heat sources. In probe stations without comprehensive thermal anchoring, the device under test may be much warmer than the sample stage itself (and of unknown temperature). Reporting device temperatures based only on a sample stage sensor where heat loads are not controlled can lead to erroneous results. Precise device characterization requires a good understanding of the device's actual temperature. To avoid injecting unwanted heat into the sample device via the probe arms, the arms and probes must be thermally anchored.

Temperature sensors Lake Shore probes are cooled to the sample stage temperature to minimize heat load to the device under test. Lake Shore sensors on the sample stage, probe arm, and radiation shield provide an accurate thermal profile of the test environment.

Compensating probe Thermal management of the arm means that compensation must also be made at the probe to offset any arm movement during variable temperature experiments. Without a compensating probe, significant ramping of sample stage temperatures may result in contact quality changes during device measurements, possibly shifting the tip enough to leave its contact pad.

Use the Cernox® reference kit to predict accurate sample stage temperature

Good science demands known experimental conditions. In some cases, sample temperature can vary widely from the set sample stage temperature. The reference Cernox substrate probing kit can take care of that. It has a calibrated Cernox sensor chip mounted to a sapphire substrate with landing pads so that the temperature can be read using four probes. This simulates the thermal loading of a sample during probing, allowing you to accurately measure sample stage temperature. The kit includes necessary adapters and cables to connect either BNC or triaxial probes to a Model 336 input.

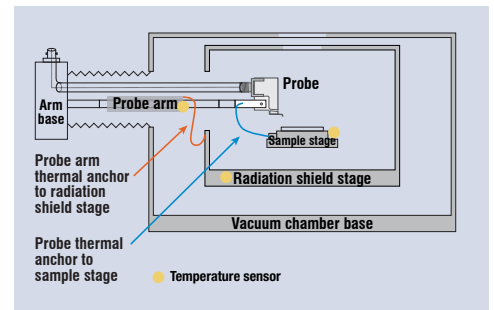

The thermal anchors in Lake Shore probe stations (shown above in the TTPX) increase sample temperature accuracy

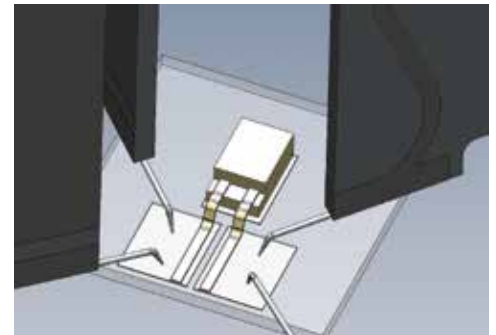

Probe tips landed on the measurement pads of the Cernox reference substrate

Get the MeasureReady 155 precision I/V source

Designed for demanding scientific and engineering applications where a low-noise source of current or voltage is required, this precision current and voltage source provides high-quality excitation for cryogenic probing. The MeasureReady 155 source operates as either a current or voltage source and provides DC and AC output. Exceptional DC noise levels are achieved without external filtering while maintaining bandwidth up to 100 kHz, providing a solid foundation for researchers performing I-V curve, Hall effect, resistance, and other fundamental measurements of novel materials and early-stage devices.

In addition to high-accuracy device testing, the source is particularly ideal for:

- Precision DC I-V and C-V curve measurements of novel materials
- Characterizing new heterostructures where low-noise bias voltages/currents are required
- Providing very low power excitation of sensitive materials like organics
- Controlled characterization of low resistance and superconducting materials

Go to www.lakeshore.com/155 for more information



Intuitive touchscreen features make it as easy to use as your smartphone!

Systems overview

Lake Shore's family of cryogenic probe stations includes entry-level models and advanced feature models. Choose from conventional liquid cryogen cooling models (shown in blue) or convenient cryogen-free cooling (shown in orange). Equivalent models in cryogenic and cryogen-free configurations are joined by a dotted line.

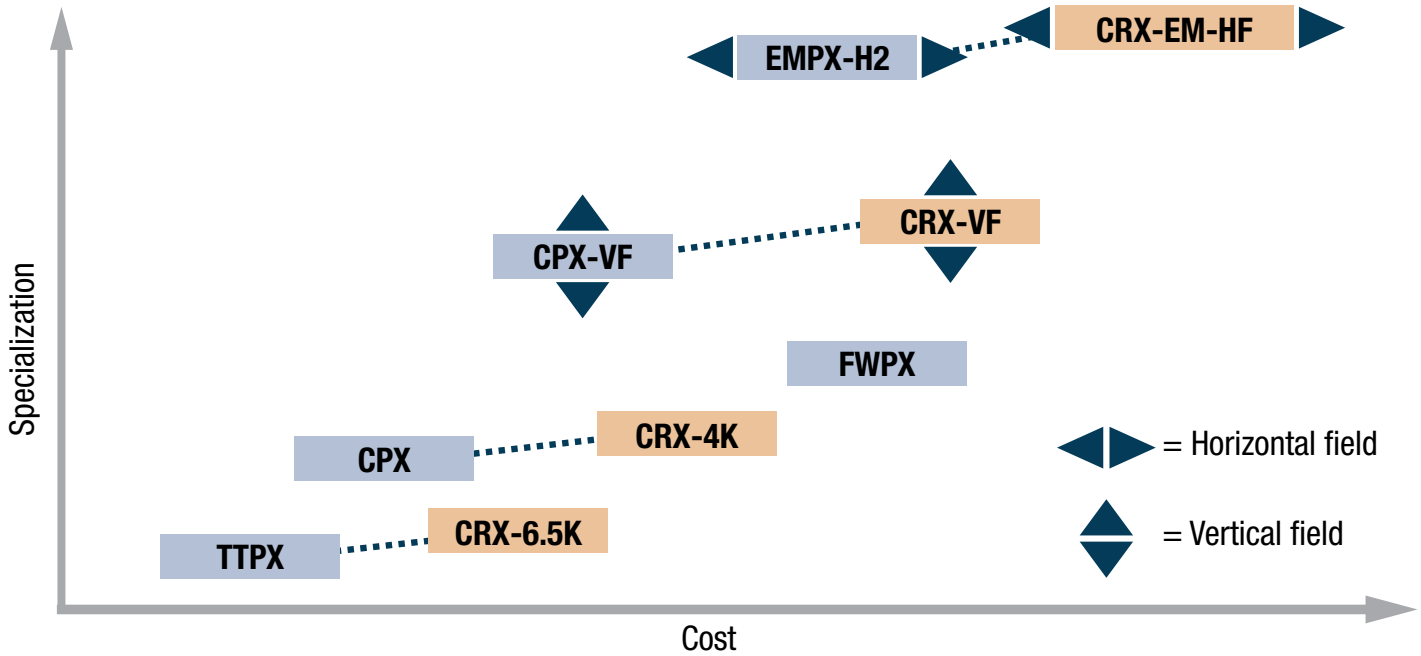

Probe station features by model

Lake Shore's probe station family features many configuration options to cover the requirements of a broad range of applications. Use the table below to identify any specific features needed and the probe station models that best meet these needs. The icons below are depicted for reference in the specification pages for each model, starting on page 30.

	Configurations — must be ordered with the station										Options — may be added in the field		Add at any time
	Cryogen-free	Magnetic field	Pneumatic vibration isolation	Stand	12:1 microscope	High vacuum	Load-lock ¹	VLT Very low temperature operation	Backside optical access	360° sample stage rotation	±5° sample stage rotation	HT High temperature operation	LT Low temperature operation
TTPX*			✓	✓	✓				✓		to 675 K	to 3.2 K	Up to ~0.19 T
CPX			✓	included	✓	✓	✓	to 1.6 K		■		to 1.9 K	Up to ~0.19 T
CPX-VF		±2.5 T vertical	✓	included	✓	✓	✓			■		to 1.9 K	
EMPX-H2		±0.6 T horizontal		included					✓			to 3.2 K	
FWPX			included	included						■		to 3.5 K	
CRX-6.5K	■			included	✓						to 675 K		Up to ~0.19 T
CRX-4K	■			included	✓						to 675 K		Up to ~0.19 T
CRX-VF	■	±2.5 T vertical		included	✓	✓	✓						
CRX-EM-HF	■	±0.6 T horizontal		included	✓				✓				

■ = feature inherent to system ✓ = feature available blank cell = feature not available

*The TTPX is available in a fully specified, preconfigured tabletop model with four-arm triaxial configuration (PS-100). For details, see page 31.

¹As a field-installable option to the load-lock, a suitcase for controlled sample transport is also available; see page 26.

Cryogen or cryogen free: which one is right for you?

For users seeking alternatives to traditional ('wet') cryogenic probe stations, Lake Shore offers 'dry' platforms: closed-cycle refrigeration (CCR) based stations that provide efficient temperature operation and control while eliminating the operating expense of liquid cryogenics. If you are concerned about price volatility in the liquid helium (LHe) supply market, a CCR-based station may be right for you.

Initial cost/operating cost comparison

Liquid cryogen-cooled models offer a lower initial platform cost. Operating costs are largely dependent upon LHe costs, which vary by region and often by season.

Cryogen-free models offer the convenience of closed cycle refrigeration, eliminating ongoing cost of liquid cryogenics. They can often pay for themselves in under three years, depending on prevailing LHe costs.

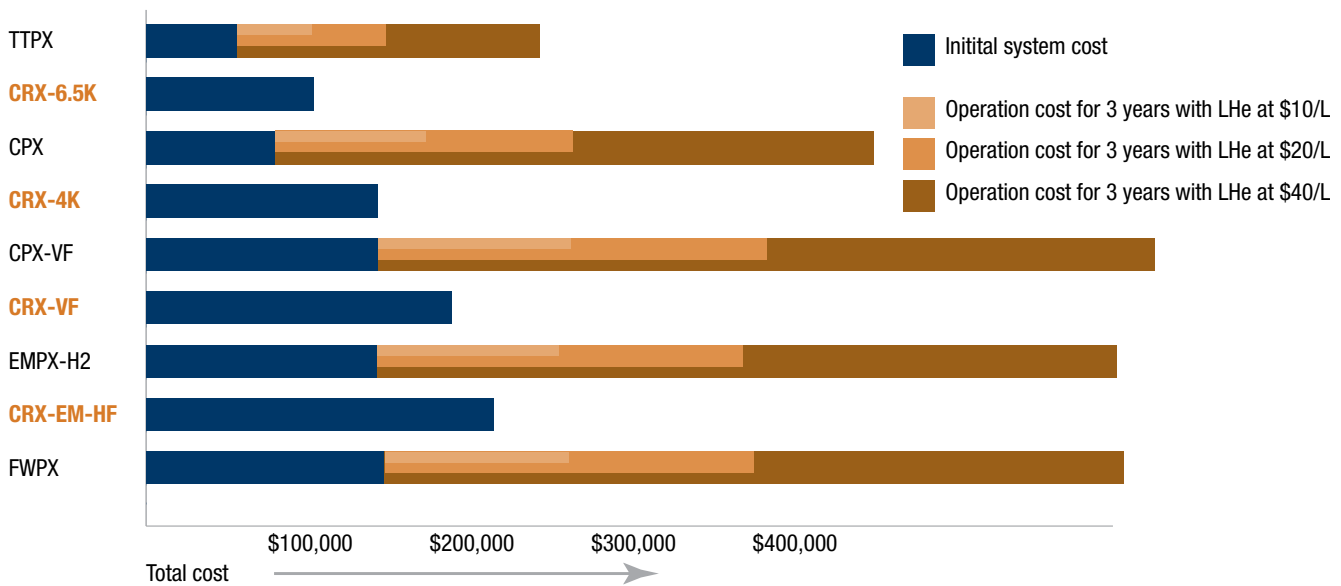

Assuming 2 cooldowns per week at a measurement length of 8 hours for 50 weeks out of the year in a typically-configured 4-arm probe station

Cryogen-free conversion path also available

If you already own a Lake Shore liquid-cooled cryogenic probe station, we offer a convenient path to convert to dry operation. By doing so, you can preserve your original investment while eliminating the need to purchase additional LHe in the future.

Our CCR upgrade allows you to easily upgrade from a cryogenic probe station to a cryogen-free probe station. The program includes an on-site exchange of the base flow probe station for a brand-new base CCR station. The upgraded station will use the original vision system, instrumentation, and probing options (such as probes, cables, and sample holders) as the original probe station.

Upgrade path for Lake Shore probe stations:

Existing probe station	with CCR upgrade, becomes
TTPX	CRX-6.5K
CPX	CRX-4K
CPX-VF	CRX-VF
EMPX(-H2)	CRX-EM-HF

Probing configurations

Flexible, expandable probing

This comprehensive line of standard micro-manipulated probe arms and accessories to meet a variety of scientific needs. Specific needs of DC, RF, microwave, and optical probing can be accommodated.

- All probes capable of operation over the full sample stage temperature, vacuum and magnetic field range of each probe station model
- For magnetic field probe stations, configurations will be non-magnetic
- One sensor is installed wired to a 6-pin feedthrough in arm location #1 standard for all probe station models. Optional sensors can be ordered (PA-SEN) with the purchase of additional probe arms (PS-PAB-XX).



The ZN50 probe base incorporates a pair of copper braids that anchor to the sample stage to dynamically cool/heat the probe to the sample temperature

Probing configurations and their uses

General purpose DC	Small signal/low noise DC measurements
High impedance DC	High impedance/low current leakage measurements
RF up to 1 GHz	Typical kHz and MHz RF measurements with banded operation up to 1 GHz; can be upgraded to RF/microwave 40 GHz with purchase of a GSG probe
RF/microwave up to 40 GHz	Measurements with up to 40 GHz compatible measurement equipment; compatible with DC/RF probes if voltage biasing or lower frequency measurements are needed that do not dictate GSG probing
RF/microwave up to 67 GHz	Measurements with 50 and 67 GHz compatible measurement equipment
Fiber optic probe	Interrogation of samples with optical stimulus, light collection from device

Probing configuration hardware

	Feedthrough	Probe	Internal cable	Planarization	Customer specifies when ordering
General purpose DC ZN50C-G	2-lug BNC	ZN50R or ZN50R-CVT	Miniature cryogenic coaxial with grounded shield	no	Probe tip material and radius, variable or fixed temperature
High impedance DC ZN50C-T	3-lug triaxial	ZN50R or ZN50R-CVT	Miniature cryogenic coaxial with shield to triaxial inner guard	no	Probe tip material and radius, variable or fixed temperature
RF up to 1 GHz HMWC-XX-00K(-NM)	2.92 mm (K-connector)	ZN50R or ZN50R-CVT	Semi-rigid coaxial, 2.92 mm with grounded shield	no	Probe tip material and radius, variable or fixed temperature
RF/microwave up to 40 GHz HMWC-XX-00K(-NM)	2.92 mm (K-connector)	40 GHz ground-signal-ground (GSG)	Semi-rigid coaxial, 2.92 mm with grounded shield	±5°	GSG pitch spacing
RF/microwave up to 67 GHz HMWC-XX-185(-NM)	1.85 mm (Z-connector)	67 GHz ground-signal-ground (GSG)	Semi-rigid coaxial, 1.85 mm with grounded shield	±5°	GSG pitch spacing
Fiber optic PS-FOAP-XX	See fiber optics—p. 21	Non-contact optical probe	Fiber optic	±5°	Fiber wavelength

Probing configuration specifications

	Operation frequency	Electrical isolation*	Capacitance	Impedance	S11/S22** (reflection)	S12/S21** (transmission)
General purpose DC	DC to 50 MHz	>100 MΩ	<100 pF	50 Ω	NA	NA
High impedance DC	DC to 50 MHz	>100 GΩ***	<100 pF	NA	NA	NA
RF up to 1 GHz	Up to 1 GHz	>10 MΩ	not specified	50 Ω	<-20 dB	<±1 dB
RF/microwave up to 40 GHz	Up to 40 GHz	>1 MΩ	not specified	50 Ω	<-20 dB	<±1 dB
RF/microwave up to 67 GHz	Up to 67 GHz	>1 MΩ	not specified	50 Ω	<-20 dB	<±1 dB
Fiber optic	See fiber optics—p. 21	NA	NA	NA	NA	NA

* Isolation measured at 100 V potential between conductive surfaces

** S21 > -10 dB up to 1 GHz, except for a (-40 dB) spike between 400 MHz depending on probe model and placement; S11 < -3 dB up to 1 GHz

*** Specified isolation will result in typical leakage currents of <100 fA in a well-designed guarded measurement system

Probe positioning

	X axis	Y axis	Z axis
Travel	51 mm (2 in)	25 mm (1 in)	18 mm (0.7 in)
Translation scale	20 μm	10 μm	10 μm

ZN50R DC/RF probes

Robust and versatile ZN50R probes are ideal for DC biasing, low/high frequency measurements, low noise shielded, and low-leakage guarded measurements. The ZN50 probe mount incorporates a pair of copper braids (not shown below) that anchor to the sample stage to cool the probe. An SMA connector is mounted directly to the alumina ceramic blade with a 50 Ω stripline routed to the probe contact.

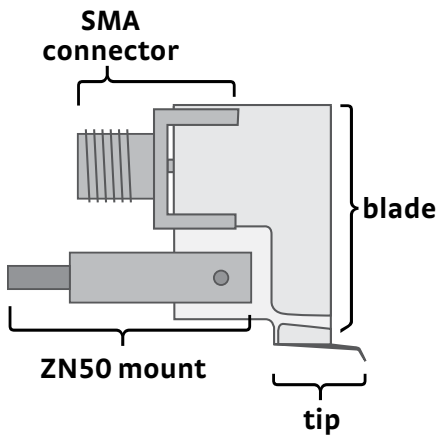

Probe model	Tip material	Tip radius (μm)
ZN50R-03-W	Tungsten	3
ZN50R-10-W		10
ZN50R-25-W		25
ZN50R-03-P7	Paliney 7	3
ZN50R-10-P7		10
ZN50R-25-P7		25
ZN50R-03-BECU	BeCu	3
ZN50R-10-BECU		10
ZN50R-25-BECU		25
ZN50R-100-BECU		100
ZN50R-200-BECU		200

Maximum frequency is 50 MHz with ZN50C-G or ZN50C-T cable.

Maximum frequency is 1 GHz with HMWC-07-00K cable.

Probe tip material	Description	Application	Conductivity	Contact resistance	Lifetime
Tungsten (W)	General purpose; durable	Good for varied surfaces; piercing oxide layers	Good	Low	Best
Beryllium copper (BeCu)	General purpose; low contact resistance	Typical gold contact landing pads	Better	Lower	Good
Paliney 7 (P7—PdAu alloy)	Specialized; low contact resistance	Delicate landing pads; minimizes scrubbing	Best	Lowest	Good

For more than 25 years, the ZN50R probe has been the cryogenic probe industry standard. Originally designed by Eric Swartz of Desert Cryogenics, the ZN50R probe design is optimized for performance from 4 K up to 675 K. Simple needle probes common in room temperature probe stations transition from the signal cable directly to the probe tip with no mechanism for blocking heat flowing along with the electrical signal. Through a novel design, the ZN50R probe solves this dilemma. The probe transitions the signal from the signal cable to a temperature stable ceramic “blade” that is cooled by the probe mount prior to transitioning to the probe tip. The ceramic material is specifically chosen for its temperature and electrical stability. This design provides key thermal cooling of the probe tip and blocks unwanted heat to the sample.

See a video on how to land a DC/RF probe at www.lakeshore.com/video

ZN50R-CVT DC/RF flexible probes

Developed in collaboration with TOYO Corporation of Japan, the patented Lake Shore Model ZN50R-CVT automatically compensates for probe arm temperature expansion of thermally anchored probes, significantly improving measurement reliability and enabling measurement automation over wide temperature ranges.

Probe model	Tip material	Tip radius (μm)
ZN50R-CVT-10-W	Tungsten	10
ZN50R-CVT-25-W		25
ZN50R-CVT-25-W-AU	Gold-coated tungsten*	25
ZN50R-CVT-25-BECU	BeCu	25

*Gold coated tungsten probes are best for soft contact material such as gold, silver, and tin.
Maximum frequency is 50 MHz with ZN50C-G or ZN50C-T cable.
Maximum frequency is 1 GHz with HMWC-07-00K cable.

The operational temperature range for keeping the ZN50R-CVT probe tip landed on a sample is defined as starting at the lowest desired temperature and warming the sample stage through the range. The starting temperature may be anywhere in the probe station's overall sample stage operating limits. The ZN50R-CVT probe's ability to keep the tip stable while landed on a sample is dependent on both the probe tip (material/radius) and on the probe station model. Composition of the landing pad is also critical to the probe performance. Specifications are given for gold plated copper. Harder or softer pads may affect temperature range.

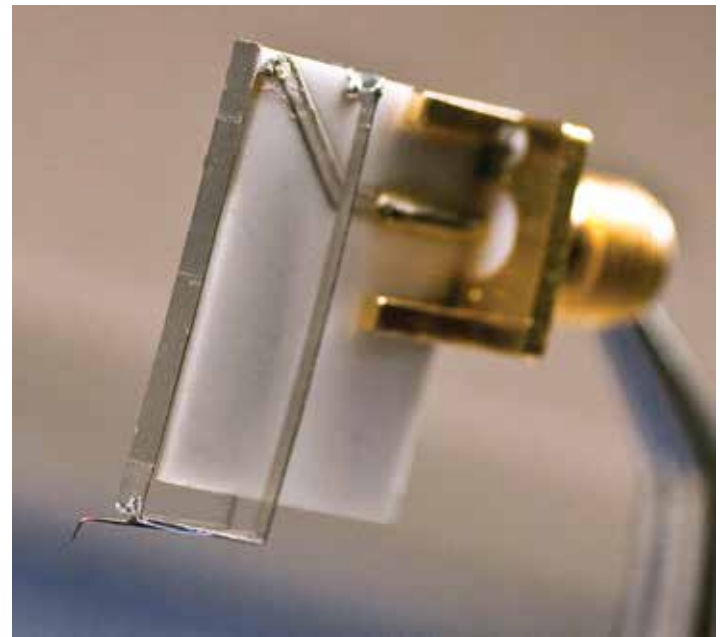

Integrated flexible member compensates for thermal expansion in the probe arm that occurs during normal operation when the sample stage temperature is changed

Every Lake Shore probe station ships with a probe starter kit that includes two ZN50R-CVT-25-W continuously variable tungsten tip probes, two ZN50R-25-W tungsten tip probes, and two ZN50R-25-BECU beryllium copper tip probes.

Temperature range per probe station model

	CPX, CPX-VF, CRX-VF	TTPX, EMPX-H2, FWPX, CRX-6.5K, CRX-4K, CRX-EM-HF
ZN50R-CVT-10-W	Δ200 K	Δ100 K
ZN50R-CVT-25-W	Δ400 K	Δ150 K
ZN50R-CVT-25-W-AU	Δ400 K	Δ150 K
ZN50R-CVT-25-BECU	Δ200 K	Δ100 K

See a video on how to land a CVT probe at www.lakeshore.com/video

Adjusting for probe travel while making measurements easier

With probe arms thermally anchored to the sample stage, a standard probe tip may move as much as 400 μm as the sample stage warms from 4.2 K to room temperature. This prevents you from making automated variable temperature measurements, as probes have to be lifted and re-landed for any significant temperature transition.



Stable tip position The patented Lake Shore CVT (continuously variable temperature) probe design absorbs probe arm movement caused by thermal expansion and contraction. The result is a stable probe tip landing position throughout variable temperature cycling.

Continuous measurements CVT probes allow you to perform continuous variable temperature measurements, which means faster and more automated experiments. You spend less time adjusting probe positions and more time conducting research. Retrofittable onto existing platforms, CVT probes enhance the overall functionality of your Lake Shore probe station by making many of your measurements easier and more convenient to perform, as well as enabling new measurement applications.

Increased efficiency plus new measurement types

Fast and convenient The ZN50R-CVT probes allow you to take continuously variable temperature measurements without lifting and repositioning your probes each time you make changes to sample stage temperature. Configure your measurement, program the sample stage temperature rate of change in your temperature controller, and go.

Increase measurement functionality In addition to improved efficiency and faster results, measurement uncertainty is greatly reduced by eliminating the variability of repeated contact landings. Even experienced users with good technique cannot totally eliminate contact resistance variation on every probe landing. Measurements including Hall effect, gated Hall, I-V, AHE, MR, DLTS, C-V, photoluminescence, and Seebeck effect are much easier and more convenient to perform.

Patented CVT tip measurement results

The figure below demonstrates the real-world measurement performance of the ZN50R-CVT probes. Hall mobility versus temperature was derived, comparing the ZN50R-CVT probes to Lake Shore standard ZN50R probes. Measurements were taken on a Lake Shore CPX-VF vertical field probe station. The ZN50R probes were lifted during temperature changes and re-landed once the temperature settled, requiring fourteen different operator interventions. The ZN50R-CVT probes were landed at 20 K and left on the sample through the temperature range of 20 K to 300 K with no operator intervention. For both experiments, temperature was ramped in point-by-point mode: the setpoint was changed, temperature allowed to settle, and measurements were taken.

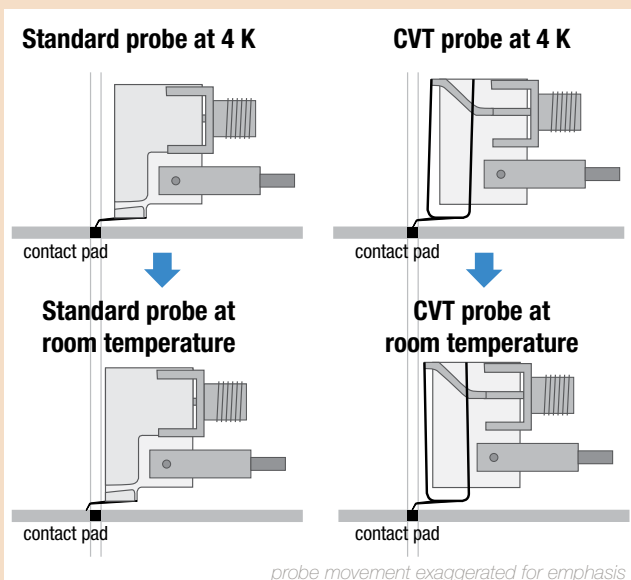

In a comparison between standard ZN50R probes and the CVT probes, you can see that the standard probes would need to be repositioned before the arms expand enough to move them off the landing position. The CVT probes flex and maintain contact with the desired location.

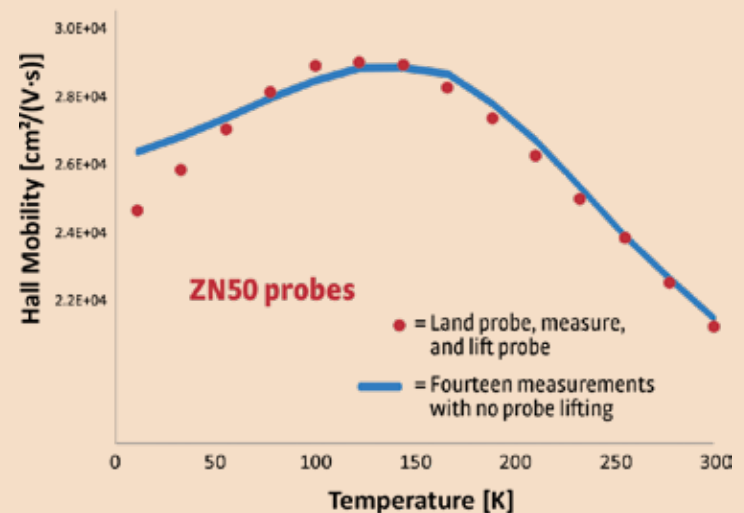

With patented ZN50R-CVT probes you don't have to constantly lift and re-land during measurements

See a video on how to land a CVT probe at www.lakeshore.com/video

Parametric probe kits

Compatible with all stations except for the TTPX and CRX-6.5K when they have the high temperature option installed.

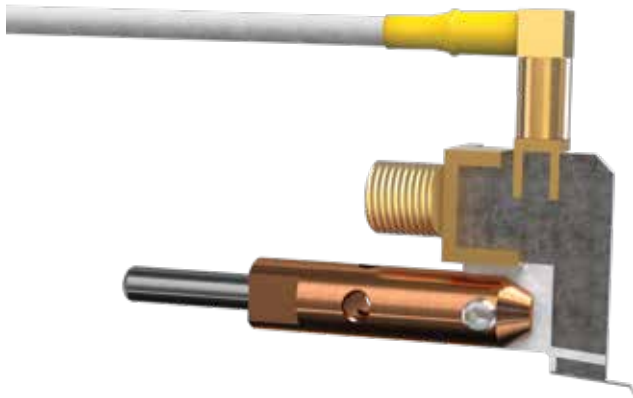

C-V measurement kit with parametric probes

What is included:

- (4) ZN50R probes with dual connectors and probe tips, which can be specified as 10 and 25 μm tungsten or 5 μm gold-coated tungsten
- (1) C-V cable
- (2) Triaxial-BNC adapter

Wafer-level capacitance-voltage (or C-V) measurements assess a range of key semiconductor parameters. The Lake Shore C-V measurement kit enables temperature-dependent, wafer-level C-V measurements using a variety of instrumentation including LCR meters and auto-balancing, bridge-type C-V meters. The C-V measurement kit includes special dual-connector probes with specified tip configurations, cabling necessary to establish a shielded, two-terminal (S-2T) configuration, and a pair of triaxial to coaxial adapters.

The S-2T configuration ties together the shields of the two probes near the device inside the probe station. This creates an efficient current return path in the shield, minimizing errors associated with the cabling and increasing the overall accuracy of the capacitance measurement.

The special dual-connector probes for C-V measurements are drop-in replacements for standard Lake Shore ZN50R probes. After mounting the probe, the standard signal cables are first connected to the SMA jack of both probes then the shorting cable is connected to the SSMB jacks of the probes. When installing the shorting cable, the probe arm should be supported from below to avoid forcing the probe tip into the sample holder. To prevent probe damage when removing the shorting cable, a small flathead screwdriver should be used to pry the shorting cable connectors from the probe jack.

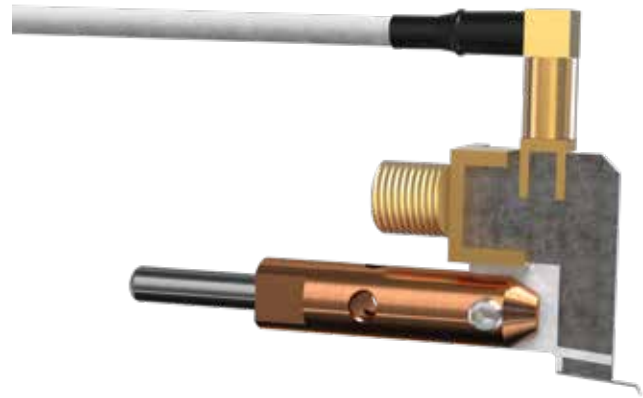

Quasi-Kelvin measurement kit with parametric probes

What is included:

- (4) ZN50R probes with dual connectors and probe tips, which can be specified as 10 and 25 μm tungsten or 5 μm gold-coated tungsten
- (2) Q-K cable
- (2) FT-TRIAX

Four-point measurements (Kelvin connection) are typically carried out in a cryogenic probe station by using four separate probe arms and probes—with one pair of arms tied to a force circuit and the second pair to a sense circuit. With Lake Shore's Quasi-Kelvin measurement kit, two connectors on each probe allow the force-sense connection to be configured using only two probe arms (limited to non-temperature sensor arms). In this way, the cable resistance is removed and low resistance measurements can be carried out even on devices with pads that can only accommodate a single probe.

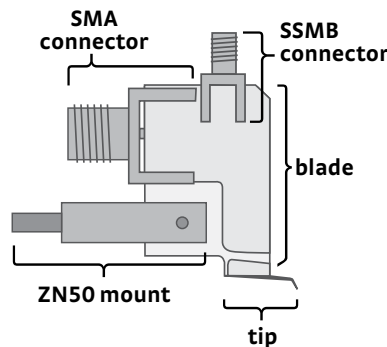

This kit includes two sets of special dual-connector probes, cabling, and vacuum feedthroughs to adapt a second probe connection through the side port on each of two standard probe arms. The special dual-connector probes used in the Quasi-Kelvin kit are drop-in replacements for standard Lake Shore ZN50R probes. After mounting the probe blade, the standard signal cables are first connected to the SMA jack of both probes, then the second top-mounted cable is connected to the SSMB jacks of the probes. When installing the SSMB cable, the probe arm should be supported from below to avoid forcing the probe tip into the sample holder. To prevent probe damage when removing the SSMB cable, a small flathead screwdriver should be used to pry the SSMB connectors from the probe jack.

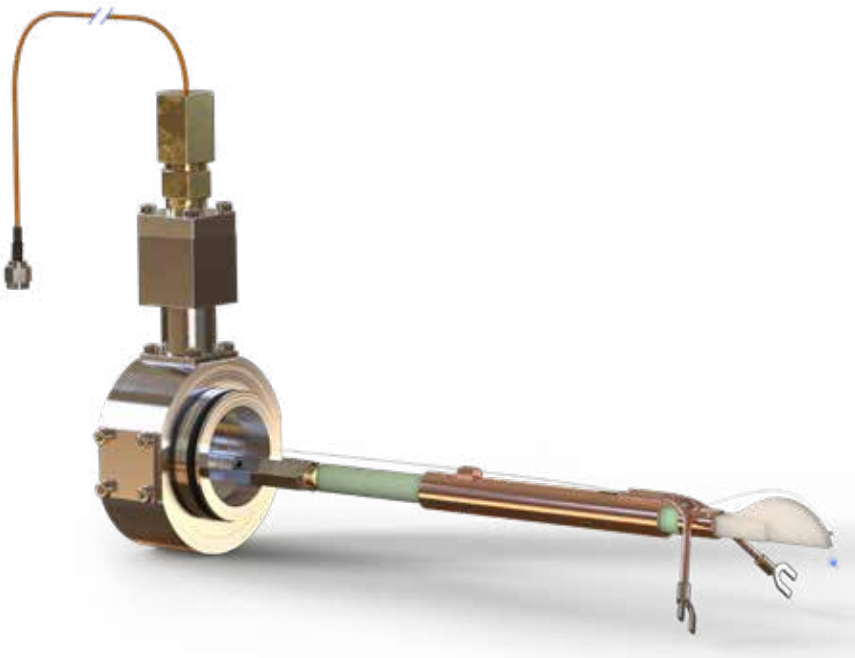

Standard fiber optic probe configurations

Designed for simultaneous illumination of or collection from an electrically-probed wafer-level device, the fiber optic probe arm features a continuous, vacuum-sealed length of fiber from connector to probe end for maximal optical throughput. Outside the vacuum chamber, there is 2.0 m of jacketed fiber terminated with either an SMA 905 or FC connector. Inside the probe station, a 0.4 m long coated fiber (with no jacket) terminates with a flat cleaved end. The cleaved end of the fiber is threaded into a fiber holder specially designed to reduce fiber breakage with inadvertent fiber/substrate touches. If the cleaved end is damaged or dirty, the fiber end can be stripped and re-cleaved.

	Wavelength (nm)	Core/cladding diameter (µm)	Connector type	Connector polish	Numerical aperture
Single mode (SM)	1290 to 1650	9/125	FC	Flat	0.14
Step index multimode IRVIS	400 to 2100	200/240	SMA	Flat	0.22
Step index multimode UVVIS	200 to 900	100/140	SMA	Flat	0.22

Single-mode—for illumination of a device from a coherent source such as a fiber-pigtailed laser diode. This fiber is typically customized for different wavelengths or with an APC connector polish (to match the source). Single-mode, polarization maintaining fibers are available for applications with a coherent, polarized source (a ferrule probe holder is used to adjust incident polarization).

Multimode IRVIS—can be used with coherent and incoherent (such as an LED) sources for illumination of a device at visible and IR wavelengths as well as collection of light from a device. This fiber is commonly customized with smaller core sizes, a 0.37 numerical aperture, or with an FC connector. Mid-IR are available upon request.

Multimode UVVIS—often used to collect light from wide-band gap devices or illuminating devices with a UV light source. This fiber can be customized with smaller core sizes, a 0.12 numerical aperture, or with an FC connector.

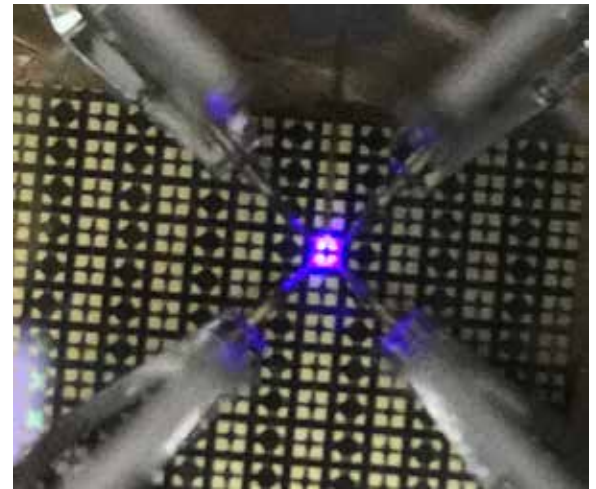

Customizations

- Fiber lengths
- Lensed fibers for focusing
- Ferruled fiber termination for 90° illumination
- Fiber arrays

Contact your Lake Shore representative for more details and to discuss your measurement needs.

Accessories (coming soon)



FC mating sleeve



SMA mating sleeve



Fiber cleaving tool

GSG microwave probes

Coplanar waveguide probe with ground-signal-ground (GSG) contact geometry. User-specified pitch (spacing). Optimized low thermal conductivity coaxial leading to low thermal conductivity tips. The integrated probe and mount includes a pair of copper braids that anchor to the sample stage to cool the probe. Limited to 475 K. A separate theta planarization module with $\pm 5^\circ$ rotation mechanism is provided.

Probe model	Connector type	Maximum frequency (GHz)	Pitch (μm)
GSG-050-40A	K	40	50
GSG-100-40A			100
GSG-150-40A			150
GSG-200-40A			200
GSG-250-40A			250
GSG-050-67A	1.85 mm	67	50
GSG-100-67A			100
GSG-150-67A			150
GSG-200-67A			200
GSG-250-67A			250

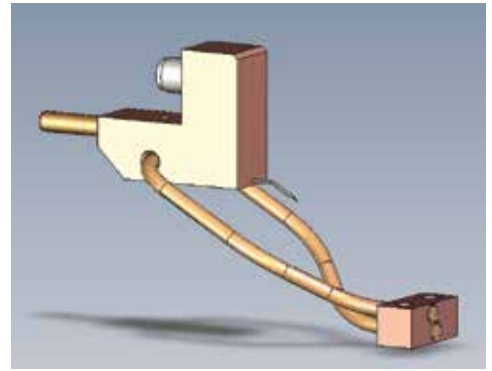

See a video on how to land a GSG probe at www.lakeshore.com/video

Sample holders

Grounded sample holder

Direct contact to the sample stage to minimize thermal gradient to sample; electrically grounded to station chassis



Coaxial sample holder

Electrically isolated sample surface with external connection for backside bias of the sample in chamber base with BNC feedthrough



Triaxial sample holder

Electrically isolated sample surface with electrically isolated guard layer between sample surface and ground; external connection for sample surface and guard in chamber base with triaxial feedthrough

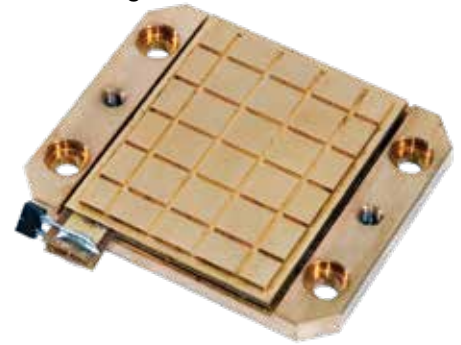

Optical access sample holder (-0, TTPX only)

Any configuration sample holder with a 5 mm hole in the center for direct line of sight to backside of sample



Ring magnet sample holder kit

The ring magnet sample holder kit provides a convenient, low-cost way to perform device testing under limited magnetic field conditions in the PS-100, TTPX, CPX, CRX-4K, and CRX-6.5K probe stations. (It is not compatible with probe stations using a low temperature option.) The kit includes a set of 4 ring magnets, 3 matched spacers, and a special, grounded sample holder to mount the magnets in one of four possible configurations.

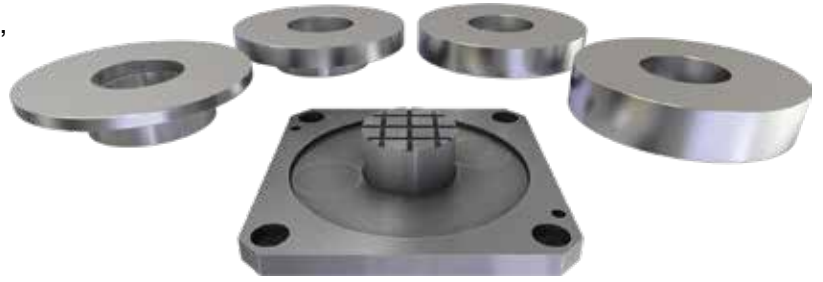

The magnets are positioned 1 mm above the top of the sample holder, creating nominal fields of 0.19 T, 0.177 T, 0.144 T, and 0.085 T at the sample holder elevation. The actual magnetic field obtained will depend on the magnet temperature. Standard operating temperature ranges for the probe station apply.

Sample holder configurations

	Sample holder type	Feedthrough required	TTPX, PS-100	CPX, CRX-6.5K, CRX-4K	CPX-VF, CRX-VF	EMPX-H2, CRX-EM-HF	FWPX	
Included with station	Grounded	None	Ø32 mm (1.25 in)	Ø32 mm (1.25 in)	Ø32 mm (1.25 in)	Ø25 mm (1 in)	Ø102 mm (4 in)	
Optional	Grounded		None	Ø51 mm (2 in)	Ø51 mm (2 in)	Ø51 mm (2 in)	Ø25 mm (1 in)	Ø102 mm (4 in)
	Coaxial	FT-BNC						
	Triaxial	FT-TRIAX						
-Optical (TTPX only) —require FT-OPTIC	Ring magnet	None	Ø17 mm (0.68 in)	Ø17 mm (0.68 in)	NA	NA	NA	
	Grounded-0		Ø32 mm (1.25 in) or Ø51 mm (2 in)					
	Coaxial-0			FT-BNC				
Triaxial-0	FT-TRIAX							

Sample holder specifications

	Electrical isolation*	Temperature difference**
Grounded	NA	0.1 K to 0.2 K
Coaxial	>100 MΩ	~1 K
Triaxial	>100 GΩ	~1 to 2 K

* Isolation measured at 100 V potential between conductive surfaces

** Temperature difference between the top of the sample holder and the sample stage temperature sensor. Additional temperature difference can be expected between the sample and sample holder, depending on mounting technique and experimental heat load.

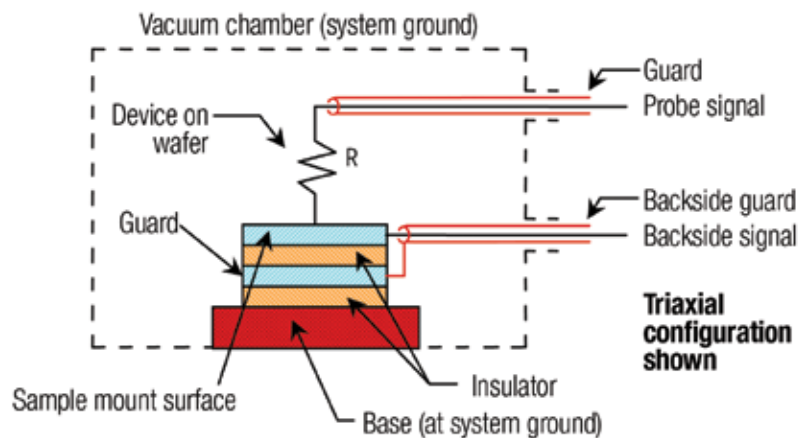

Feedthroughs

FT-BNC	2-lug BNC feedthrough installed and wired for coaxial sample holders
FT-TRIAX	3-lug triaxial feedthrough installed and wired for triaxial sample holders

Optical access kit

FT-OPTIC	Optical access kit—includes window, window holder, tower, and related components
-----------------	--

Vision system



The probe station's vision system is critical for distinguishing characteristics of the sample and properly landing probes. The standard vision system implements 7:1 optics with a high sensitivity, high definition camera and high resolution monitor. The HD camera is specifically chosen for low light sensitivity to minimize the lighting required for high image quality. The choice of an appropriate lighting type is especially important for sample visualization because it strongly influences the behavior of the vision system. Therefore, Lake Shore includes both coaxial light and ring light illumination standard with the vision system.

The 1951 USAF glass slide resolution target images shown to the right demonstrate the smallest feature resolved for both the standard and optional vision system. Optical analysis of the images show the improved resolving power of the optional 12:1 vision system. Based on the optical analysis, the smallest feature that can be visualized in each probe station model is summarized to the right. The FWPX probe station has a longer working distance than the other stations, requiring an alternative lens in the optics.

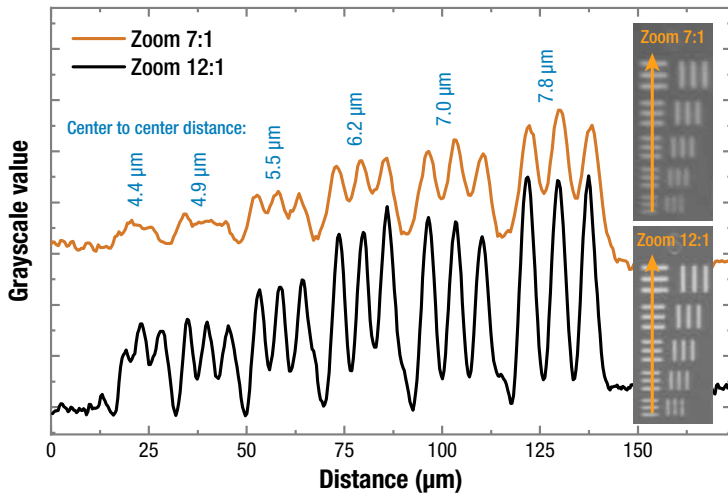

Probe station model	Standard 7:1 smallest visualized feature	Optional 12:1 smallest visualized feature
TTPX	2.8 µm	<2.5 µm
CPX	2.8 µm	<2.5 µm
CPX-VF	2.8 µm	<2.5 µm
EMPX-H2	2.8 µm	<2.5 µm
FWPX	6.2 µm	—
CRX-6.5K	2.8 µm	<2.5 µm
CRX-4K	2.8 µm	<2.5 µm
CRX-VF	2.8 µm	<2.5 µm
CRX-EM-HF	2.8 µm	<2.5 µm

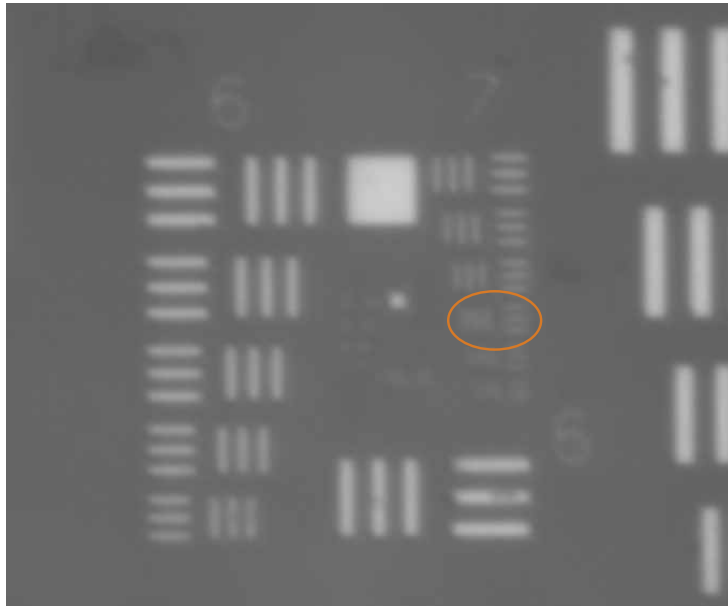

Left: smallest feature visualized (approximately 3 µm) obtained with standard 7:1 microscope and coaxial light on a CPX-VF probe station

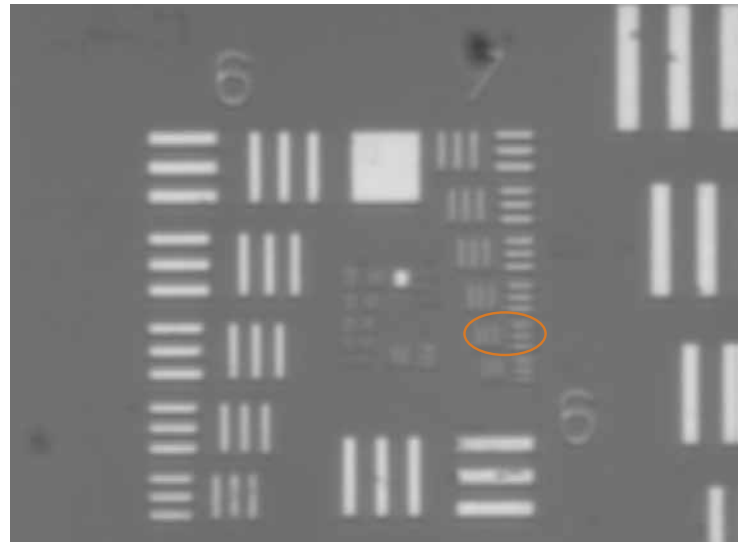

Right: smallest feature visualized (approximately 2.5 µm) obtained with a 12:1 microscope option and coaxial light on a CPX-VF probe station

Options for every application

Installed options

Unless otherwise specified, these options must be configured at the time of probe station purchase.

Temperature

VLT Very low temperature CPX

Extends the minimum sample temperature of the CPX probe station to 1.6 K base temperature by lowering the pressure inside the sample stage heat exchanger. Limits high end temperature of probe station to 420 K. The PS-VLT-CPX includes a SH-1.00-G grounded sample holder, 4 K shield, rotary vane pump, manual valve control, and connection adapters. The modified sample stage is optimized for cooling 25 mm (1 in) samples. Additional sample holders for the VLT operation are sold separately. 3-phase 208 V 50/60 Hz operation. 50 Hz operation may increase base temperature.

Vibration

Pneumatic vibration isolation system CPX, CPX-VF, TTPX

For vibration sensitive applications, the PS-PVIS (PS-TTVIS for the TTPX) configuration is recommended when probing extremely fine detail, when making measurements that are very sensitive to mechanical noise, or when there are likely to be outside vibration sources near the probe station. The option adds active pneumatic vibration isolation to the integrated stand and requires a regulated source of 40 psi compressed air or nitrogen.

Function

Heavy duty welded steel stand TTPX

The PS-STAND-TTPX provides a stable platform for the TTPX.

12:1 microscope upgrade TTPX, CPX, CPX-VF, CRX-4K, CRX-6.5K, CRX-VF, CRX-EM-HF

Upgrades the probe station vision system to 12:1 microscope for higher magnification. See the Vision System page for additional details.

360° sample stage rotation EMPX-H2, CRX-EM-HF

Provides 360° rotation of the sample stage. The PS-360-EMPX is recommended for measurements that require changing the sample alignment relative to the magnetic field. The rotation stage is also useful for aligning GSG probe tips for microwave measurements. Limits the overall temperature range to 8 K to 420 K. The thermal gradient between the top of the rotation stage and the sample stage temperature sensor is <2 K over the full temperature range. Standard sample holders can be used when the rotation stage is removed. The rotation stage requires configuration of the sample cooling assembly to accommodate the rotation controls. (Cannot be used in conjunction with the high temperature stage.)



Load-lock and sample suitcase CPX, CPX-VF, CRX-VF

The load lock assembly (PS-LL-CPX) allows samples to be exchanged under controlled environmental conditions without warming the radiation shields or breaking vacuum, significantly improving efficiency and throughput by reducing cycle time to roughly 1 h when used on the CPX or CPX-VF and about 2 h on the CRX-VF. This option's overall temperature range is <10 K to 420 K. It includes an electrically isolated adapter for the sample stage, two transfer sample holders, and modified radiation shields that provide load lock access. The electrical isolation is compatible with FT-TRIAx and FT-BNC feedthroughs.

Available for use with the load lock is a suitcase (PS-SC-CPX), which enables quick sample transfers between controlled environments and features a vacuum flange adaptable for various standard glove box fittings. A sample is loaded into the suitcase's sample carriage, and once the suitcase is mounted on the underside of the load lock chamber, the sample can be shuttled to the cold stage with ease. This mechanism protects the active material surfaces or delicate organic materials from atmospheric contamination—a crucial capability in a number of material characterization applications.

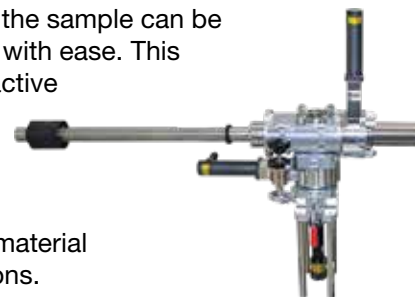

Field installable options

These options can be ordered at any time and either configured with a probe station or installed in the field.

Temperature

HT High temperature

TTPX, CRX-6.5K, CRX-4K

Extends the maximum sample temperature using a sample stage with integrated thermal standoffs, calibrated temperature sensor, and heater. The temperature range of the PS-HTSTAGE option is from 20 K to 675 K and can accommodate 50 mm (2 in) diameter samples; it reduces z-axis travel to 11 mm. Standard sample holders can be used when the high-temperature stage is removed. There are simple steps in the operation manual to reconfigure an existing heater output to drive the stage. Requires manual switching of the 100 W radiation shield heater for closed-loop control. The PS-HTSTAGE is not compatible with RF, MCW, parametric probes, FT-OPTIC optical access kit, or the ability to backside bias the sample.



LT Low temperature

TTPX, CPX, CPX-VF, FWPX, EMPX-H2

Extends the minimum sample temperature by lowering the base pressure inside the sample stage heat exchanger (see individual model specifications). The PS-LT option includes system modifications, a stainless steel bellows and a DS402 rotary vane pump with oil mist eliminator. Single phase worldwide 50/60 Hz operation. 50 Hz operation may increase base temperature.



Vacuum

High vacuum kit

CPX, CPX-VF, CRX-VF (FWPX—consult Lake Shore)

Lowers the ultimate base pressure up to two decades and reduces pump down time. Critical for samples sensitive to contamination or condensation, like in high Z and low current applications, the PS-HV-CPX option ensures that condensation does not accumulate on the sample during cooldown. A modification to the station chamber port allows an ISO100 gate valve and integrated vibration isolator to mount the ISO100 turbo pump directly to the chamber. Includes dry scroll backing pump, full range gauge mounted to vacuum chamber and turbo controller with gauge readout integrated into the electronics console.



Compact turbo pumping system

All probe stations

Evacuates the probe station vacuum chamber. The TPS-FRG includes a V-81 turbo pump (NW 40 inlet) with oil free dry scroll backing pump, FRG-700 full range gauge, controller, and interface cable to USB port. Full range gauge allows measurement of pressure from atmosphere to 10^{-8} Torr. The included interface cable allows connection to a standard USB computer port for vacuum pressure logging; includes an Agilent 24 month warranty. Requires the PS-TP-KIT.



Turbo pumping kit

All probe stations

Connects any NW 40 inlet turbo pumping station to a probe station. The PS-TP-KIT includes a 1 m NW 40 bellows, a tee for inline gauge mounting, and all necessary clamps/fittings; it also includes NW 25 and NW 16 adaptors for transfer line maintenance evacuation.

Field installable options

These options can be ordered at any time and either configured with a probe station or installed in the field.

Vacuum, continued

Pump line vibration isolators

All probe stations

Minimize vibration from a pump to a probe station. The PS-PLVI-40 is used for turbo pumping stations, and includes NW 40 fittings, 1 m stainless steel bellows, clamps, and rings. The PS-PLVI-25 minimizes vibration from a rotary vane pump or a backing pump, and is recommended for use with the PS-LT low temperature options or with the PS-HV-CPX high vacuum option. It includes NW 25 fittings, 1 m stainless steel bellows, clamps, and rings. Both options require one bag of cement.



Probing

Cernox® reference substrate

All probe stations

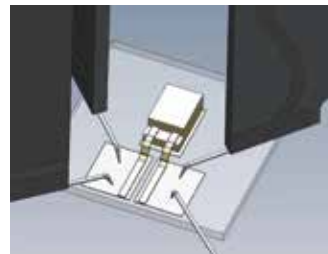

Simulates the thermal loading of a sample during probing. The PS-REF-CRX consists of a calibrated CX-1050-SD-HT-1.4M sensor chip mounted to a 10 mm × 10 mm × 0.45 mm thick sapphire substrate with landing pads. There are no leads to the sensor;

temperature is read using four ZN50R probes. Kit includes temperature cable and adapters to connect four BNC or triaxial configured probe arms to the temperature sensor input on the Model 336. Also includes sample clamps and additional probe arm shields to further minimize radiation on the sample. The temperature range is 2 K to 420 K.

Microwave probe calibration substrates

All probe stations

Calibrate GSG probes with the CS-5 and CS-15 substrates. Calibrations supported are SOLT (short-open-load-through), LRL (line-reflective-line), LRM (line-reflective-match). Pitch range for the CS-5 is 75 to 250 μm and for the CS-15 is 40 to 150 μm.

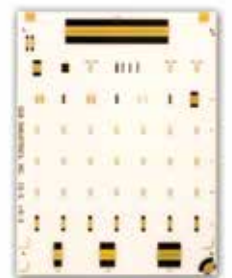

Function

Backside optical access

TTPX

Provides direct, line of sight, optical access to the back (bottom) side of the sample when used with an optical access sample holder (sold separately). The FT-OPTIC option is beneficial when measuring samples that are optically active on the side opposite the one being electrically probed. The kit includes a 25 mm (1 in) quartz viewport and related components to mount on the bottom of the vacuum chamber. The opening in the sample stage and optical sample holders is 5.08 mm (0.2 in). The working distance between the viewport and sample is approximately 147 mm (5.79 in). The optical access is configured at Lake Shore when ordered with the probe station, but it is easy to install in the field when ordered separately. Lake Shore offers the choice of several compatible optical access sample holders.

Dewar

TTPX, CPX, CPX-VF, FWPX, EMPX-H2

The 1220-50 nitrogen laboratory storage Dewar has 50 L liquid capacity and a 12.7 mm (0.5 in) top withdraw port that is compatible with the probe station transfer line. Constructed of durable stainless steel, the Dewar includes a pressure gauge, gas port, gas valve, and 68.9 kPa (10 psi) pressure relief valve for safe and convenient operation.

Nitrogen transfer line

TTPX, CPX, CPX-VF, FWPX, EMPX-H2

The PS-TLF-LNA high flow capacity transfer line (for all stations listed above except the FWPX) is 500 mm (20 in) shorter than the standard transfer line for a better fit with the 1220-50 Dewar. The PS-TLF-LNB is specially adapted for use with the FWPX only.

Chillers

EMPX-H2, CRX-6.5K, CRX-4K, CRX-VF, CRX-EM-HF

For recommended chiller models, visit www.lakeshore.com.

TTPX

Tabletop probe station



- Entry-level system
- Compact table-top design
- Affordable
- Rapid cooldown and warmup
- Backside optical access

The TTPX probe station is an affordable, entry-level probe station capable of making a wide variety of non-destructive, standard electrical device measurements. The compact table-top design is perfect for academic and laboratory research settings. The TTPX provides efficient cryogenic temperature operation and control with a continuous refrigeration system using either liquid helium or liquid nitrogen.

The TTPX operates over a temperature range of 4.2 K to 420 K with options to extend as low as 3.2 K or to a higher range of 20 K to 675 K. This model accommodates full and partial wafers up to 51 mm (2 in) in diameter. A wide selection of probes, cables, sample holders, and options makes it possible to meet specific measurement applications.

The TTPX is Lake Shore's premium design for electro-optical materials characterization with the backside optical access option and compatible optical sample holders. I-V, C-V, and microwave measurements are standard options on the TTPX. Its versatility and affordability make the TTPX the tool of choice for many researchers around the world.

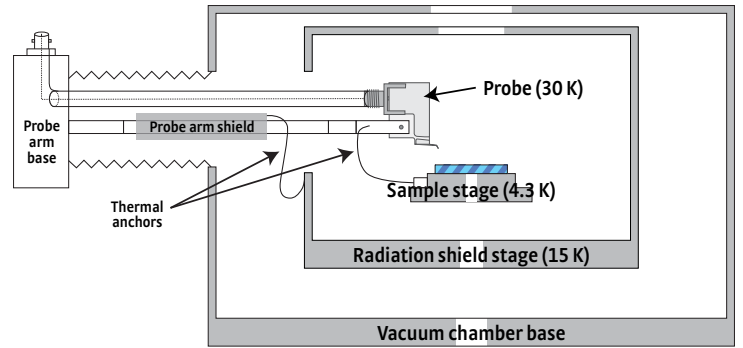

Description and specifications

Sample cooling assembly

Type: 2-stage flow cryostat (sample + radiation shield)
 Radiation shielding: Radiation shield with top viewport surrounds sample
 Cooling source: Liquid helium (LHe) or liquid nitrogen (LN₂)

Magnetic field: Ring magnet kit—see page 22

Temperature

Base temperature	Control range	Configuration
4.3 K	4.4 K to 420 K	2 probe arms installed
4.325 K	4.4 K to 420 K	4 probe arms installed
4.35 K	4.4 K to 420 K	6 probe arms installed
3.2 K	3.3 K to 420 K	with PS-LT option
20 K	20 K to 675 K	with PS-HTSTAGE option (not compatible with backside biasing of the sample)

Control stability

Sample stage temperature	Helium stability	Nitrogen stability
Base temperature (no heater control)	±15 mK	±20 mK
<10 K	±50 mK	—
10 K to 100 K	±20 mK	±50 mK
100 K to 250 K	±15 mK	±50 mK
251 K to 350 K	±15 mK	±100 mK
351 K to 420 K	±50 mK	±100 mK
421 K to 675 K	±50 mK	±100 mK

Vacuum

	Standard TPS-FRG
Pump down time	15 min (to reach $<1 \times 10^{-3}$ Torr)
Room temperature	$<5 \times 10^{-4}$ Torr
Helium base temperature	$<1 \times 10^{-5}$ Torr
Maximum temperature	$<5 \times 10^{-3}$ Torr

Cycle time (LHe): 2 h
 Vacuum pump down: 15 min
 Station cooldown: 45 min
 Station warmup: 60 min

Vibration at sample:

	Standard	PS-TTVIS option
X axis		
Y axis	<300 nm (11.8 µin)	<30 nm (1.18 µin)
Z axis		

Sample

Maximum sample size:	51 mm (2 in) diameter
Sample backside optical access:	5 mm (0.2 in) diameter
Sample rotation:	Not an option

Probing

Maximum probes:	6
Probe arm sensor:	Included for monitoring probe temperature
Cooled probe mounts:	<35 K with sample at base temperature
Probe mount:	Thermally anchored to sample stage
Probe arm:	Thermally anchored to radiation shield
DC/RF probes:	Electrical isolation >100 GΩ for low leakage measurements
Microwave probes:	Frequency range DC up to 67 GHz
Fiber optic probes:	Available for electro-optical measurements
Probe landing:	All probes can land at single point in a 25 mm (1 in) diameter circle

Load lock: Not an option

High vacuum: Not an option

Cryogen consumption

Room to base temperature (total):	3.5 liquid L helium; 2.5 liquid L nitrogen
Helium at 5 K:	3 liquid L/h
Nitrogen at 80 K:	<0.5 liquid L/h

Station details

Temperature equipment

Sample stage sensor/heater power:	DT-670-CU-HT calibrated silicon diode/50 W
Radiation shield sensor/heater power:	DT-670C-CU silicon diode/100 W
Probe arm:	DT-670C-SD silicon diode (on one probe arm)/no active control

Temperature controller:	Model 336
Helium transfer line:	Helium/nitrogen transfer line with flow control 12.7 mm (0.5 in) top port withdrawal

Included sample holder: Removable SH-1.25-G, 31.8 mm (1.25 in) maximum sample size, grounded

Station footprint: 654 mm (25.8 in) width × 676 mm (26.6 in) depth

Vacuum chamber

Material:	Electroless nickel-plated aluminum
Overall size:	203 mm (8 in) outer diameter × 132 mm (5.2 in) tall
Chamber access:	152 mm (6 in) diameter opening
Viewport:	63.5 mm (2.50 in) diameter fused quartz
Viewing area:	54.0 mm (2.13 in) diameter
Pump port:	NW 25 with included vacuum isolation valve
Gauge port:	Not an option
Gas port:	0.25 in NPT with valve
Over pressure safety:	3.5 kPa (0.5 psi) pressure relief valve

Radiation shielding

Material:	Electroless nickel-plated aluminum
Sample access:	122 mm (4.8 in) diameter lid
Viewport:	50 mm (1.97 in) diameter IR absorbing window
Viewing area:	50 mm (1.97 in) diameter

Included kits

Tool kit:	Included tools for standard operation
Spares kit:	Included kit for common consumable items
Probe starter kit:	ZN50R-25-W (qty 2), ZN50R-25-BECU (qty 2), and ZN50R-CVT-25-W (qty 2) for training







Utilities

1-phase voltage:	100/120/220/240 VAC (+5%, -10%), 50/60 Hz
1-phase power:	1.7 kVA recommended
3-phase voltage:	not required
3-phase power:	not required
Cooling water:	not required

Approval All instruments CE marked

Optional configurations

See pages 26–29 for option descriptions

-  **Optical access (FT-OPTIC)**
-  **Vibration isolation (PS-TTVIS)**
-  **Stand (PS-STAND)**
-  **LT Low temperature (PS-LT-CPX)**
-  **HT High temperature (PS-HTSTAGE)**
-  **12:1 microscope (PS-Z12)**

Options

See page 26 for description

-  **Ring magnet kit (PS-RING-MAG-KIT)**

Want a preconfigured TTPX? Order a four-arm PS-100 and get it shipped to you fast

This model offers versatile testing in a fully specified system—ideal for labs with limited funding. Plus, because it's a preconfigured probe station, it can typically be in your lab worldwide in less than a month from the time it's ordered. Just add cryogen and a vacuum pump.



The PS-100 comes preconfigured for sensitive, high-impedance DC measurements for use in a variety of applications. It features a four-arm triaxial configuration for four-point probing and operates over a 4.2 K to 475 K temperature range. High-precision, micro-manipulated stages ensure accurate probe tip placement, and it holds samples up to 32 mm (1.25 in) in diameter.

In addition to four probe holders and a probe starter kit, the PS-100 includes a Model 336 temperature controller and accessories for easy setup. When your needs change later, simply add other TTPX options.

For more information, go to www.lakeshore.com.

CPX

High performance probe station



- Lake Shore's most versatile probe station
- Numerous options and configurations available
- Multiple radiation shields for best low temperature performance
- Minimizes sample condensation during cooldown
- Customizable for sample transfer with no exposure to atmosphere
- Customizable to accommodate a 4 in wafer

With a modular design to meet the needs of a breadth of experiments, the CPX is Lake Shore's most versatile, high performance cryogenic probe station. Various options and configurations on the CPX enable the researcher to conduct exacting, challenging test measurements. The CPX has multiple radiation shields to provide Lake Shore's best low temperature performance with configurations enabling sample temperatures as low as 1.6 K. Multiple temperature sensors throughout the station ensure accurate, repeated measurements.

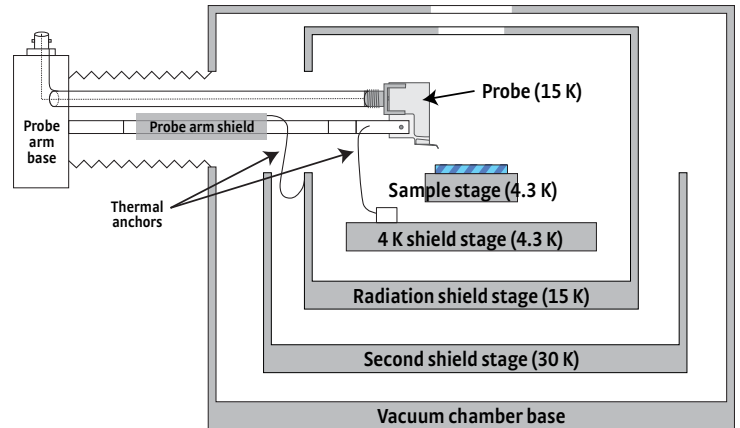

Description and specification

Sample cooling assembly

Type: 1 + 3-stage split flow cryostat (sample + 3 radiation shields); dual exhaust ports with independent flow control of sample and shields
 Radiation shielding: Inner 4 K (partial) radiation shield; main radiation shield with top viewport surrounds sample; outer second (partial) radiation shield
 Cooling source: Liquid helium (LHe) or liquid nitrogen (LN₂)

Magnetic field: Ring magnet kit—see page 22

Temperature¹

Base temperature	Control range	Configuration
4.3 K	4.4 K to 420 K	Up to 6 probe arms installed
1.9 K	2 K to 420 K	with PS-LT option
1.6 K	1.65 K to 420 K	with PS-VLT-CPX option
10 K	10 K to 420 K	with PS-LL-CPX option

Control stability

Sample stage temperature	Helium stability	Nitrogen stability
Base temperature (no heater control)	±15 mK	±20 mK
<10 K	±50 mK	—
10 K to 100 K	±20 mK	±50 mK
100 K to 250 K	±15 mK	±50 mK
251 K to 350 K	±15 mK	±100 mK
351 K to 420 K	±50 mK	±100 mK

Due to the split flow design, the sample stays warm while the shields cool, which, along with the high vacuum option, minimizes sample condensation during cooldown—a key requirement for measuring hydrophilic organic materials. Ideal applications include research in organics and microwave measurements. Vacuum load-locks are configurable for conducting high-throughput measurements. In addition, the CPX can be configured to enable controlled sample transport under vacuum to the chamber. The CPX accommodates 51 mm (2 in) diameter wafers (up to 102 mm [4 in] optional). The system operates with either liquid helium or liquid nitrogen.

Vacuum

	Standard TPS-FRG	PS-HV-CPX option
Pump down time	30 min (to reach $<1 \times 10^{-3}$ Torr)	10 min (to reach $<1 \times 10^{-3}$ Torr)
Room temperature	$<5 \times 10^{-4}$ Torr	$<5 \times 10^{-6}$ Torr
Helium base temperature	$<1 \times 10^{-5}$ Torr	$<5 \times 10^{-7}$ Torr
Maximum temperature	$<5 \times 10^{-5}$ Torr	$<5 \times 10^{-7}$ Torr

Cycle time (He):	3 h
Pump down time:	0.5 h
Station cooldown:	1.25 h
Station warmup:	2 h
Load-lock sample exchange:	1 h with PS-LL-CPX option

Vibration at sample

	Standard	PS-PVIS option
X axis	<300 nm (11.8 μ m)	<30 nm (1.18 μ m)
Y axis		
Z axis		

Sample

Maximum sample size:	51 mm (2 in) diameter 25.4 mm (1 in) diameter with PS-VLT-CPX option 25.4 mm (1 in) diameter with PS-LL-CPX option
----------------------	--

Sample backside optical access:	Not an option
Sample rotation:	$\pm 5^\circ$ in-plane rotation

Probing

Maximum probes:	6
Probe arm sensor:	Included for monitoring probe temperature
Cooled probe mounts:	<20 K with sample at base temperature
Probe mount:	Thermally anchored to sample stage or 4 K shield
Probe arm:	Thermally anchored to radiation shield
DC/RF probes:	Electrical isolation >100 G Ω for low leakage measurements
Microwave probes:	Frequency range DC up to 67 GHz for RF measurements
Fiber optic probes:	Available for electro-optical measurements
Probe landing:	All probes can land at single point in a 25 mm (1 in) diameter circle

Cryogen consumption²

Room to base temperature (total):	10 to 15 liquid L helium; 4 to 5 liquid L nitrogen
Helium at 5 K:	1 liquid L/h
Nitrogen at 80 K:	<0.5 liquid L/h

¹ Base temperature assumes heat load for probes thermally anchored as listed in probing section

² Assumes maximum number of probe arms installed

Station details

Temperature equipment

Sample stage sensor/heater power:	DT-670-CU-HT calibrated silicon diode/50 W
(PS-VLT sensor optimized for <4 K):	CX-1050-CU-HT-1.4M calibrated Cernox®/50 W
4 K radiation shield sensor/heater power:	DT-670C-CU silicon diode/100 W
Radiation shield sensor/heater power:	DT-670C-CU silicon diode/100 W
2nd radiation shield sensor/heater power:	DT-670C-CU silicon diode/50 W
Probe arm:	DT-670C-SD silicon diode (on one probe arm)/no active control

Electronics console:	
Temperature controllers:	Two Model 336s
Helium transfer line:	Large bore helium/nitrogen transfer line with flow control 12.7 mm (0.5 in) top port withdrawal

Included sample holder: Removable SH-1.25-G, 31.8 mm (1.25 in) maximum sample size, grounded

Station footprint: 800 mm (31.5 in) width \times 670 mm (26.4 in) depth (does not include instrument console)

Vacuum chamber

Material:	Electroless nickel-plated aluminum
Overall size:	280 mm (11 in) outer diameter \times 343 mm (13.5 in) tall
Chamber access:	229 mm (9 in) diameter opening
Viewport:	63.5 mm (2.50 in) diameter fused quartz
Viewing area:	54.0 mm (2.13 in) diameter
Pump port:	NW 40 with included vacuum isolation valve
Gauge port:	NW 25 (two ports)
Gas port:	0.25 in NPT with valve
Over pressure safety:	3.5 kPa (0.5 psi) pressure relief valve

Radiation shielding

Material:	Electroless nickel-plated aluminum
Sample access:	167 mm (6.6 in) diameter lid
Viewport:	50 mm (1.97 in) diameter IR absorbing window
Viewing area:	50 mm (1.97 in) diameter

Included kits

Tool kit:	Included tools for standard operation
Spares kit:	Included kit for common consumable items
Probe starter kit:	ZN50R-25-W (qty 2), ZN50R-25-BECU (qty 2), and ZN50R-CVT-25-W (qty 2) for training

Utilities







1-phase voltage:	100/120/220/240 VAC (+5%, -10%), 50/60 Hz
1-phase power:	2 kVA recommended
3-phase voltage:	Not required
3-phase power:	Not required
Cooling water:	Not required

Approval

All instruments CE marked

Optional configurations

See pages 26–29 for option descriptions

-  **Load lock (PS-LL-CPX)**
-  **High vacuum (PS-HV-CPX)**
-  **Low temperature (PS-LT-CPX)**
-  **Very low temperature (PS-VLT-CPX)**
-  **Vibration isolation (PS-PVIS)**
-  **12:1 microscope (PS-Z12)**

Options

See page 26 for description

-  **Ring magnet kit (PS-RING-MAG-KIT)**

CPX-VF

Superconducting magnet-based vertical field probe station

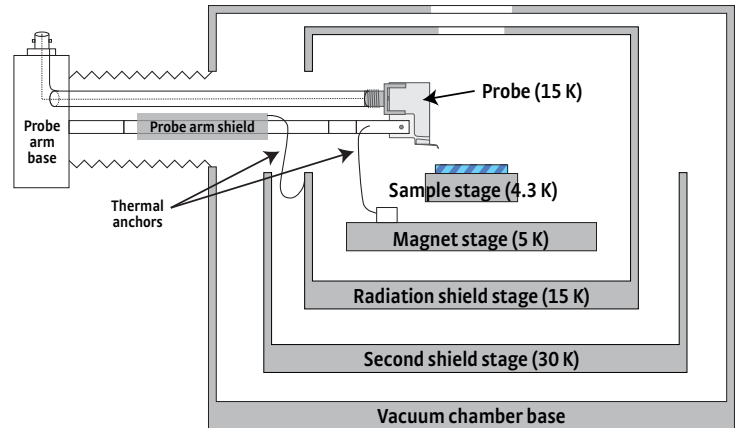

- Standard probing plus out-of-plane vertical field superconducting magnetic measurements
- Multiple radiation shields for best low temperature performance
- Minimizes sample condensation during cooldown
- True 90° probing
- Customizable for Hall measurements
- Customizable up to 3 T with specialized probes

The Lake Shore CPX-VF probe station enhances the standard probe station capabilities with the addition of a ± 2.5 T vertical field superconducting magnet. It can do all the standard C-V, I-V, microwave, and electro-optical probing of the CPX, plus out-of-plane vertical field superconducting magnetic measurements. Researchers can use it for performing Hall effect measurements and testing magneto-transport parameters. The CPX-VF is one of Lake Shore's premium probe stations for combining microwave measurements with magnetic field.

Description and specification

Sample cooling assembly

Type: 1 + 3-stage split flow cryostat (sample + magnet + 2 radiation shields); dual exhaust ports with independent flow control of sample and magnet

Radiation shielding: Magnet radiation shield; main radiation shield with top viewport surrounds sample; outer second (partial) radiation shield

Cooling source: Liquid helium (LHe)

Magnetic field

Magnet type: Superconducting solenoid
 Field orientation: Vertical (perpendicular to the sample plane)
 Field control: Current control
 Field capability: ± 25 kOe (± 2.5 T)
 Field homogeneity: 0.5% over 10 mm diameter; 1.0% over 25 mm diameter
 Landed probe tip movement: $< 5 \mu\text{m}$ full field ramp

Temperature¹

Base temperature	Control range	Configuration
4.3 K	4.4 K to 420 K	Up to 6 probe arms installed
1.9 K	2 K to 420 K	with PS-LT option

Control stability

Sample stage temperature	Helium stability
Base temperature (no heater control)	± 15 mK
< 10 K	± 50 mK
10 K to 100 K	± 20 mK
100 K to 250 K	± 15 mK
251 K to 350 K	± 15 mK
351 K to 420 K	± 50 mK

The CPX-VF is designed to enable true 90° wafer probing on wafers up to 51 mm (2 in) in diameter. The sample can be maintained at elevated temperature during cooldown reducing the potential for condensation, a critical requirement for measuring organic materials. The continuous refrigeration station uses liquid helium and can be operated with liquid nitrogen; however, the superconducting magnet requires liquid helium to operate. The CPX-VF operates over a temperature range of 4.2 K to 420 K with the option to extend the base temperature to 2 K.

Vacuum

	Standard TPS-FRG	PS-HV-CPX option
Pump down time	30 min (to reach $<1 \times 10^{-3}$ Torr)	10 min (to reach $<1 \times 10^{-3}$ Torr)
Room temperature	$<5 \times 10^{-4}$ Torr	$<5 \times 10^{-6}$ Torr
Helium base temperature	$<1 \times 10^{-5}$ Torr	$<5 \times 10^{-7}$ Torr
Maximum temperature	$<5 \times 10^{-5}$ Torr	$<5 \times 10^{-7}$ Torr

Cycle time (LHe):	4 h
Pump down time:	0.5 h
Station cooldown:	2 h
Station warmup:	1.5 h

Vibration at sample

	Standard	PS-PVIS option
X axis	<300 nm (11.8 μ m)	<30 nm (1.18 μ m)
Y axis		
Z axis		

Sample

Maximum sample size:	51 mm (2 in) diameter
Sample backside optical access:	Not an option
Sample rotation:	$\pm 5^\circ$ in-plane rotation

Probing

Maximum probes:	6
Probe arm sensor:	Included for monitoring probe temperature
Cooled probe mounts:	<20 K with sample at base temperature
Probe mount:	Thermally anchored to magnet radiation shield
Probe arm:	Thermally anchored to radiation shield
DC/RF probes:	Electrical isolation >100 G Ω for low leakage measurements
Microwave probes:	Frequency range DC up to 67 GHz for RF measurements
Fiber optic probes:	Available for electro-optical measurements
Probe landing:	All probes can land at single point in a 25 mm (1 in) diameter circle

Cryogen consumption²

Room to base temperature (total):	15 to 20 liquid L helium
Helium at 5 K:	1 to 2 liquid L/h

¹ Base temperature assumes heat load for probes thermally anchored as listed in probing section

² Assumes maximum number of probe arms installed

Station details

Temperature equipment

Sample stage sensor/heater power:	CX-1050-CU-HT-1.4M calibrated Cernox®/50 W
Magnet stage sensor/heater power:	CX-1030-CU calibrated Cernox®/100 W
Radiation shield sensor/heater power:	DT-670C-CU silicon diode/100 W
2nd radiation shield sensor/heater power:	DT-670C-CU silicon diode/50 W
Probe arm:	DT-670C-SD silicon diode (on one probe arm)/no active control

Electronics console:	
Temperature controllers:	Two Model 336s
Magnet power supply:	Model 625
Helium transfer line:	Large bore helium/nitrogen transfer line with flow control 12.7 mm (0.5 in) top port withdrawal

Included sample holder:	Removable SH-1.25-G, 31.8 mm (1.25 in) maximum sample size, grounded
--------------------------------	--

Station footprint:	800 mm (31.5 in) width \times 670 mm (26.4 in) depth (does not include instrument console)
---------------------------	--

Vacuum chamber

Material:	Electroless nickel-plated aluminum
Overall size:	280 mm (11 in) outer diameter \times 343 mm (13.5 in) tall
Chamber access:	229 mm (9 in) diameter opening
Viewport:	63.5 mm (2.50 in) diameter fused quartz
Viewing area:	54.0 mm (2.13 in) diameter
Pump port:	NW 40 with included vacuum isolation valve
Gauge port:	NW 25 (two ports)
Gas port:	0.25 in NPT with valve
Over pressure safety:	3.5 kPa (0.5 psi) pressure relief valve

Radiation shielding

Material:	Electroless nickel-plated aluminum
Sample access:	194 mm (7.6 in) diameter lid
Viewport:	50 mm (1.97 in) diameter IR absorbing window
Viewing area:	50 mm (1.97 in) diameter

Included kits

Tool kit:	Included tools for standard operation
Spares kit:	Included kit for common consumable items
Probe starter kit:	ZN50R-25-W (qty 2), ZN50R-25-BECU (qty 2), and ZN50R-CVT-25-W (qty 2) for training





Utilities

1-phase voltage:	100/120/220/240 VAC (+5%, -10%), 50/60 Hz
1-phase power:	2 kVA recommended
3-phase voltage:	Not required
3-phase power:	Not required
Cooling water:	Not required

Approval	All instruments CE marked
-----------------	---------------------------

Optional configurations

See pages 26–29 for option descriptions

-  **Load lock (PS-LL-CPX)**
-  **Vibration isolation (PS-PVIS)**
-  **12:1 microscope (PS-Z12)**
-  **High vacuum (PS-HV-CPX)**
-  **Low temperature (PS-LT-CPX)**

EMPX-H2

Electromagnet-based horizontal field probe station



- Standard probing plus in-plane horizontal field electromagnetic measurements
- Generate full field without cryogen or cooldown
- Probes configured at 30° angles to accommodate electromagnet

The Lake Shore EMPX-H2 probe station enhances standard probe station capabilities with the addition of a ± 0.6 T horizontal field electromagnet. All standard C-V, I-V, microwave, and electro-optical probing, plus in-plane horizontal field electromagnetic measurements can be performed on this versatile station. Researchers can use it for testing magneto-transport parameters. The EMPX-H2 is Lake Shore's premier probe station for vector-dependent magneto-transport measurements.

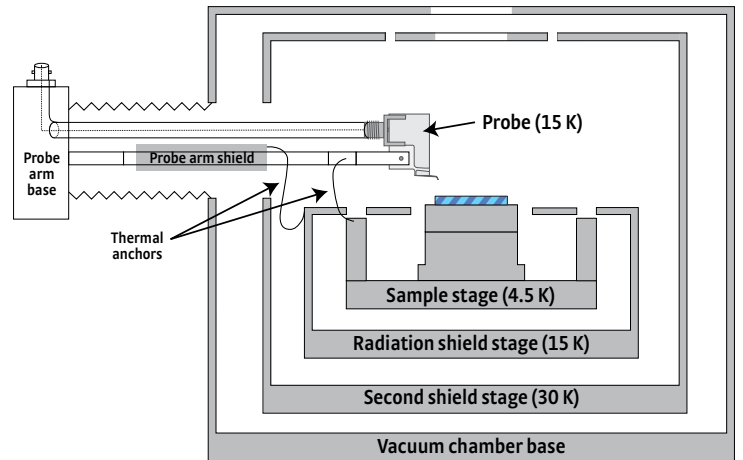

Description and specification

Sample cooling assembly

Type: 3-stage flow cryostat (sample + 2 radiation shields)
 Radiation shielding: Partial inner radiation shield; second radiation shield with top viewport surrounds sample
 Cooling source: Liquid helium (LHe) or liquid nitrogen (LN₂)

Magnetic field

Magnet type: Electromagnet
 Field orientation: Horizontal (parallel to the sample plane)
 Field control: Hall probe installed in station for closed loop control
 Field capability: ± 6.0 kOe (± 0.6 T)
 Field homogeneity: 0.6% over 10 mm diameter; 2.6% over 25 mm diameter
 Landed probe tip movement: < 5 μ m full field ramp

Temperature¹

Base temperature	Control range	Configuration
4.5 K	5 K to 420 K	Up to 4 probe arms installed
3.2 K	3.3 K to 420 K	with PS-LT option

Control stability

Sample stage temperature	Helium stability	Nitrogen stability
Base temperature (no heater control)	± 20 mK	± 50 mK
< 10 K	± 50 mK	—
10 K to 100 K	± 50 mK	± 100 mK
100 K to 250 K	± 50 mK	± 100 mK
251 K to 420 K	± 50 mK	± 100 mK

To maximize magnetic field at the sample, the EMPX-H2 probes are configured at 30° angles for probing wafers up to 25 mm (1 in) in diameter. A 360° sample stage rotation option allows measurement of angular-dependent and anisotropic magneto-transport properties. The EMPX-H2 operates over a temperature range of 4.5 K to 420 K, with options to extend the base temperature to 3.2 K. The continuous refrigeration EMPX-H2 can be operated with liquid helium or liquid nitrogen for cooling.

Vacuum

	Standard TPS-FRG
Pump down time	30 min (to reach $<1 \times 10^{-3}$ Torr)
Room temperature	$<5 \times 10^{-4}$ Torr
Helium base temperature	$<1 \times 10^{-5}$ Torr
Maximum temperature	$<5 \times 10^{-3}$ Torr

Cycle time:	3 h
Pump down time:	0.5 h
Station cooldown:	1.25 h
Station warmup:	1.25 h

Vibration at sample: <300 nm standard

Sample

Maximum sample size:	25.4 mm (1 in) diameter
Sample backside optical access:	Not an option
Sample rotation:	Optional 360° rotation stage (PS-360-EMPX)

Probing

Maximum probes:	4 (see orientation diagram)
Probe arm sensor:	Included for monitoring probe temperature
Cooled probe mounts:	<20 K with sample at base temperature
Probe mount:	Thermally anchored to sample stage
Probe arm:	Thermally anchored to radiation shield
DC/RF probes:	Electrical isolation >100 GΩ for low leakage measurements
Microwave probes:	Frequency range DC up to 67 GHz for RF measurements
Fiber optic probes:	Available for electro-optical measurements
Probe landing:	All probes can land at single point in a 25 mm (1 in) diameter circle

Cryogen consumption²

Room to base temperature (total):	10 liquid L helium; 5 liquid L nitrogen
Helium at 5 K:	1 to 2 liquid L/h
Nitrogen at 80 K:	<0.5 liquid L/h

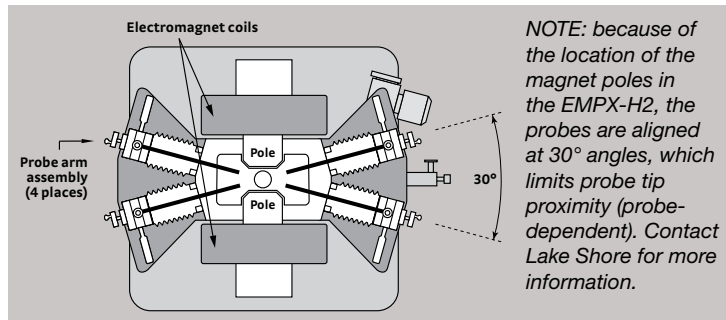

¹ Base temperature assumes heat load for probes thermally anchored as listed in probing section

² Assumes maximum number of probe arms installed

Station details

Temperature equipment

Sample stage sensor/heater power:	CX-1050-CU-HT-1.4M/100 W
Radiation shield sensor/heater power:	DT-670C-CU silicon diode/100 W
Second rad shield sensor/heater power:	DT-670C-CU silicon diode/100 W
Probe arm:	DT-670C-SD silicon diode (on one probe arm)/no active control

Electronics console:

Temperature controller:	Model 336
Warm-up amplifier:	Model 142
Gaussmeter:	Model 475
Magnet power supply:	Model 643
Helium transfer line:	Large bore helium/nitrogen transfer line with flow control 12.7 mm (0.5 in) top port withdrawal

Included sample holder:

Removable SH-1.00-G-EM, 25.4 mm (1 in) maximum sample size, grounded

Station footprint:

914 mm (36 in) width × 660 mm (26 in) depth (does not include console)

Vacuum chamber

Material:	Electroless nickel-plated aluminum
Overall size:	191 mm (7.5 in) × 340 mm (13.4 in) × 292 mm (11.5 in) tall
Chamber access:	133.4 mm (5.25 in) × 243.2 mm (9.58 in) opening
Viewport:	63.5 mm (2.50 in) diameter fused quartz
Viewing area:	54.0 mm (2.13 in) diameter
Pump port:	NW 40 with included vacuum isolation valve
Gauge port:	NW 25
Gas port:	0.25 in NPT with valve
Over pressure safety:	3.5 kPa (0.5 psi) pressure relief valve

Radiation shielding

Material:	Electroless nickel-plated aluminum
Sample access:	59 mm (2.3 in) × 157 mm (6.2 in)
Viewport:	50 mm (1.97 in) diameter IR absorbing window
Viewing area:	50 mm (1.97 in) diameter

Included kits

Tool kit:	Included tools for standard operation
Spares kit:	Included kit for common consumable items
Probe starter kit:	ZN50R-25-W (qty 2), ZN50R-25-BECU (qty 2), and ZN50R-CVT-25-W (qty 2) for training

Utilities



1-phase voltage:	100/120/220/240 VAC (+5%, -10%), 50/60 Hz
1-phase power:	2 kVA recommended
3-phase voltage (EM):	200/208, 220/230, 380, 400/415 VAC (±10%), 50/60 Hz
3-phase power (EM):	5.5 kVA max 50/60 Hz
Cooling water power dissipation (EM):	5 kW max, 50/60 Hz

Approval

All instruments CE marked

Optional configurations

See pages 26–29 for option descriptions

-  **360° sample rotation (PS-360-EMPX)**
-  **LT Low temperature (PS-LT-CPX)**

FWPX

Large-size wafer probe station



- Largest wafer sample size: 4 in
- Sample translation for rapid probing
- Customizable to accept 6 in wafers

Lake Shore's FWPX probe station is designed for researchers who require large-size wafer probing. The FWPX accommodates wafers up to 102 mm (4 in) in diameter and can be modified to accept up to 152 mm (6 in) wafers. This general-purpose probe station is designed for researchers or engineers conducting material characterization tests over large samples. It is also an effective unit for measuring organic materials.

The FWPX employs a continuous refrigeration system using either liquid helium or liquid nitrogen for wafer cooling. It operates over a temperature range of 4.5 K to 420 K with the option to extend the base temperature to 3.5 K. I-V, C-V, and microwave measurements are standard. The station is configurable with up to six thermally anchored micro-manipulated probe arms and is optimally designed for electro-optical testing.

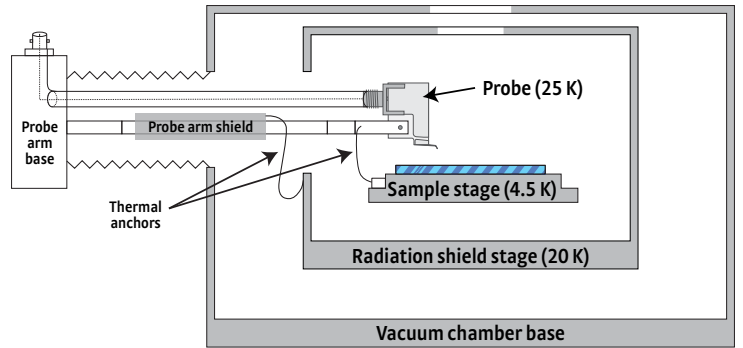

Description and specification

Sample cooling assembly

Type: 2-stage flow cryostat (sample + radiation shield)
 Radiation shielding: Radiation shield with top viewport surrounds sample
 Cooling source: Liquid helium (LHe) or liquid nitrogen (LN₂)

Magnetic field: Not an option

Temperature¹

Base temperature	Control range	Configuration
4.5 K	5 K to 420 K	Up to 6 probe arms installed
3.5 K	4 K to 420 K	with PS-LT option

Control stability

Sample stage temperature	Helium stability	Nitrogen stability
Base temperature (no heater control)	±20 mK	±20 mK
<10 K	±50 mK	—
10 K to 100 K	±20 mK	±50 mK
100 K to 250 K	±20 mK	±50 mK
251 K to 350 K	±20 mK	±100 mK
351 K to 420 K	±50 mK	±100 mK

Vacuum

	Standard TPS-FRG
Pump down time	30 min (to reach $<1 \times 10^{-3}$ Torr)
Room temperature	$<5 \times 10^{-4}$ Torr
Helium base temperature	$<1 \times 10^{-5}$ Torr
Maximum temperature	$<5 \times 10^{-3}$ Torr

Cycle time (LHe):	3.5 h
Vacuum pump down:	0.5 h
Station cooldown:	1.5 h
Station warmup:	1.5 h

Vibration at sample: <30 nm standard

Sample

Maximum sample size:	102 mm (4 in) diameter
Sample backside optical access:	Not an option
Sample rotation:	$\pm 5^\circ$ in-plane rotation
Sample translation:	Translation in x- and y-axis for full 102 mm (4 in) wafer probing

Probing

Maximum probes:	6
Probe arm sensor:	Included for monitoring probe temperature
Cooled probe mounts:	<30 K with sample at base temperature
Probe mount:	Thermally anchored to sample stage
Probe arm:	Thermally anchored to radiation shield
DC/RF probes:	Electrical isolation >100 G Ω for low leakage measurements
Microwave probes:	Frequency range DC up to 67 GHz for RF measurements
Fiber optic probes:	Available for electro-optical measurements
Probe landing:	All probes can land at single point in 51 mm (2 in) diameter circle

Cryogen consumption²

Room to base temperature (total):	10 liquid L helium; 6 liquid L nitrogen
Helium at 5 K:	<5 liquid L/h
Nitrogen at 80 K:	<0.5 liquid L/h

¹ Base temperature assumes heat load for probes thermally anchored as listed in probing section

² Assumes maximum number of probe arms installed

Station details

Temperature equipment

Sample stage sensor/heater power:	DT-670-CU-HT calibrated silicon diode/100 W
Radiation shield sensor/heater power:	DT-670C-CU silicon diode/100 W
Probe arm:	DT-670C-SD silicon diode (on one probe arm)/no active control

Electronics console:

Temperature controllers:	Two Model 336s
Helium transfer line:	Large bore S-style helium/nitrogen transfer line with flow control 12.7 mm (0.5 in) top port withdrawal

Included sample holder:

Removable SH-4.00-G, 102 mm (4 in) maximum sample size, grounded

Station footprint:

1067 mm (42 in) width \times 851 mm (33.5 in) depth (does not include console)

Vacuum chamber

Material:	Electroless nickel-plated aluminum
Overall size:	406 mm (16 in) outer diameter \times 178 mm (7 in) tall
Chamber access:	330 mm (13 in) diameter opening
Viewport:	102 mm (4.0 in) diameter fused quartz
Viewing area:	91 mm (3.6 in) diameter
Pump port:	NW 40 with included vacuum isolation valve
Gauge port:	NW 25
Gas port:	0.25 in NPT with valve
Over pressure safety:	3.5 kPa (0.5 psi) pressure relief valve

Radiation shielding

Material:	Electroless nickel-plated aluminum
Sample access:	180 mm (7.1 in) diameter lid
Viewport:	159 mm (6.25 in) diameter IR absorbing window
Viewing area:	152 mm (6.0 in) diameter

Included kits:

Tool kit:	Included tools for standard operation
Spares kit:	Included kit for common consumable items
Probe starter kit:	ZN50R-25-W (qty 2), ZN50R-25-BECU (qty 2), and ZN50R-CVT-25-W (qty 2) for training

Utilities:

1-phase voltage:	100/120/220/240 VAC (+5%, -10%), 50/60 Hz
1-phase power:	2 kVA recommended
3-phase voltage:	Not required
3-phase power:	Not required
Cooling water:	Not required

Approval

All instruments CE marked

Optional configurations

See pages 26–29 for option descriptions

LT Low temperature (PS-LT-CPX)

CRX-6.5K

Affordable cryogen-free probe station



- Cryogen-free operation
- Push-button operation and allows unsupervised cooldown
- Affordability

The CRX-6.5K provides a low-cost, general-purpose solution for those looking for the convenience of cryogen-free operation and the dependable measurement performance of a Lake Shore product. Using a self-contained closed cycle refrigerator (CCR), the station cools down to cryogenic temperatures unassisted, eliminating the need for monitoring by the researcher. Its versatility and affordability make the CRX-6.5K the tool of choice for many researchers worldwide.

I-V, C-V, and microwave measurements are standard on the CRX-6.5K. The 2-stage CCR allows the sample to be maintained at elevated temperature during cooldown, reducing the potential for condensation, a critical requirement for measuring organic materials.

The CRX-6.5K operates over a temperature range of 8 K to 350 K with the option to extend to a higher range of 20 K to 675 K. This model accommodates full and partial wafers up to 51 mm (2 in) in diameter. A wide selection of probes, cables, sample holders, and options makes it possible to meet specific measurement applications.

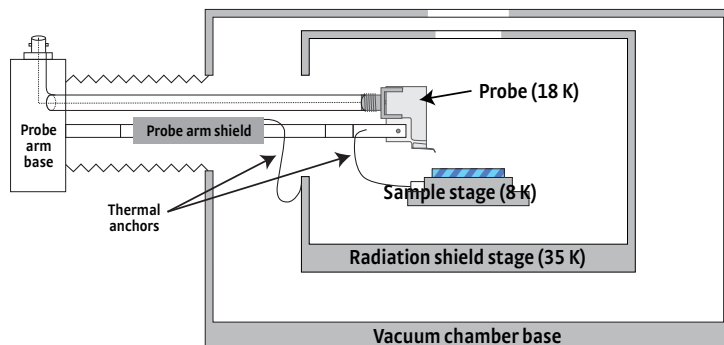

Description and specification

Sample cooling assembly

Type: 2-stage (sample + radiation shield)
Radiation shielding: Radiation shield with top viewport surrounds sample
Cooling source: 2-stage closed cycle refrigerator (CCR) with 3 W cooling power at 10 K

Magnetic field: Ring magnet kit—see page 22

Temperature¹

Base temperature	Control range	Configuration
8 K	8.5 K to 350 K	2 probe arms installed
9 K	9.5 K to 350 K	4 probe arms installed
10 K	10.5 K to 350 K	6 probe arms installed
20 K	20 K to 675 K	with PS-HTSTAGE option (not compatible with backside biasing of the sample)

Control stability

Sample stage temperature	Stability
Base temperature (no heater control)	Not specified
<10 K	±25 mK
11 K to 350 K	±10 mK
351 K to 675 K	±50 mK

Vacuum

Room temperature:	$<5 \times 10^{-4}$ Torr
Helium base temperature:	$<1 \times 10^{-5}$ Torr
Maximum temperature (shields cold):	$<5 \times 10^{-5}$ Torr

Cycle time:	6.25 h
Pump down time:	0.5 h
Station cooldown:	3.5 h
Station warmup:	2.25 h

Vibration at sample: $<2 \mu\text{m}$

Sample

Maximum sample size:	51 mm (2 in) diameter
Sample backside optical access:	Not an option
Sample rotation:	Not an option

Probing

Maximum probes:	6
Probe arm sensor:	Included for monitoring probe temperature
Cooled probe mounts:	<20 K with sample at base temperature
Probe mount:	Thermally anchored to sample stage
Probe arm:	Thermally anchored to radiation shield
DC/RF probes:	Electrical isolation $>100 \text{ G}\Omega$ for low leakage measurements
Microwave probes:	Frequency range DC up to 67 GHz for RF measurements
Fiber optic probes:	Available for electro-optical measurements
Probe landing:	All probes can land at single point in a 25 mm (1 in) diameter circle

Optics package

Maximum magnification:	8 \times
Minimum resolution:	4 μm
Light source:	Dual coaxial and ring light illumination

Cryogen consumption

Room to base temperature (total):	Not required
Helium at 5 K:	Not required

¹ Base temperature assumes heat load for probes thermally anchored as listed in probing section

Station details

Temperature equipment

Sample stage sensor/heater power:	DT-670-CU-HT calibrated silicon diode/100 W
Radiation shield sensor/heater power:	DT-670C-CU silicon diode/50 W
CCR 2nd stage sensor/heater power:	DT-670A-CU silicon diode/50 W installed but not actively monitored
CCR 1st stage sensor/heater power:	DT-670C-CU silicon diode/100 W
Probe arm:	DT-670C-SD silicon diode (on one probe arm)/no active control
Temperature controller:	Model 336
Helium transfer line:	Not required

Included sample holder: Removable SH-1.25-G, 31.8 mm (1.25 in) maximum sample size, grounded

Station footprint: 654 mm (25.8 in) width \times 676 mm (26.6 in) depth (does not include CCR compressor)

Vacuum chamber

Material:	Electroless nickel-plated aluminum
Overall size:	203 mm (8 in) outer diameter \times 132 mm (5.2 in) tall
Chamber access:	152 mm (6 in) diameter opening
Viewport:	63.5 mm (2.50 in) diameter fused quartz
Viewing area:	54.0 mm (2.13 in) diameter
Pump port:	NW 25 with included vacuum isolation valve
Gauge port:	NW 25
Gas port:	0.25 in NPT with valve
Over pressure safety:	3.5 kPa (0.5 psi) pressure relief valve

Radiation shielding

Material:	Electroless nickel-plated aluminum
Sample access:	132 mm (5.2 in) diameter lid
Viewport:	50 mm (1.97 in) diameter IR absorbing window
Viewing area:	50 mm (1.97 in) diameter

Included kits

Tool kit:	Included tools for standard operation
Spares kit:	Included kit for common consumable items
Probe starter kit:	ZN50R-25-W (qty 2), ZN50R-25-BECU (qty 2), and ZN50R-CVT-25-W (qty 2) for training

Utilities

1-phase voltage:	100/120/220/240 VAC (+5%, -10%), 50/60 Hz
1-phase power:	1.5 kVA recommended
1-phase voltage (CCR):	208/230 V (+5%), 60 Hz or 200/230/240 (+5%), 50 Hz (2 pole, 3 wire single phase plus ground, 20 A)
1-phase power (CCR):	3.0 kW, 15.5 A full load at 208 V, 60 Hz; 2.6 kW, 13 A full load at 200 V, 50 Hz
Cooling water power dissipation (CCR):	3.2 kW 50/60 Hz

Approval All instruments CE marked

Optional configurations

See pages 26–29 for option descriptions

HT High temperature (PS-HTSTAGE)

 **12:1 microscope (PS-Z12)**

Options

See page 26 for description

 **Ring magnet kit (PS-RING-MAG-KIT)**

CRX-4K

High performance closed cycle refrigerator-based probe station



- Cryogen-free operation
- Allows unsupervised cool down
- Low temperature operation
- Minimizes sample condensation during cooldown
- Customizable to accommodate a 102 mm (4 in) wafer

Designed for versatility and high performance, the CRX-4K is our premium cryogen-free closed cycle refrigerant probe station. This system is the solution for those looking for the convenience of cryogen-free operation and the exceptional measurement performance of a Lake Shore product. Using a self-contained closed cycle refrigerator (CCR), the station cools down to cryogenic temperatures unassisted, eliminating the need for monitoring by the researcher. Various options and configurations on the CRX-4K enable the researcher to conduct exacting, challenging test measurements. The CRX-4K provides Lake Shore's best low-temperature cryogen-free performance, with configurations enabling sample temperatures as low as 4.5 K. Multiple temperature sensors throughout the station ensure accurate, repeated measurements.

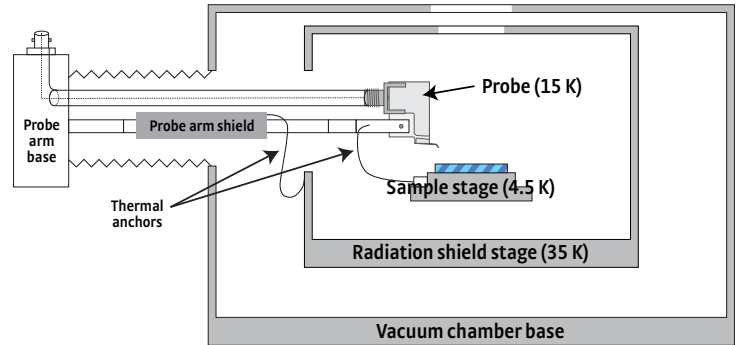

Description and specification

Sample cooling assembly

Type: 2-stage (sample + radiation shield)
 Radiation shielding: Radiation shield with top viewport surrounds sample
 Cooling source: 2-stage closed cycle refrigerator (CCR) with 1 W cooling power at 4.2 K

Magnetic field: Ring magnet kit—see page 22

Temperature¹

Base temperature	Control range	Configuration
4.5 K	5 K to 350 K	2 probe arms installed
5.5 K	6 K to 350 K	4 probe arms installed
6.0 K	6.5 K to 350 K	6 probe arms installed
20 K	20 K to 675 K	with PS-HTSTAGE option (not compatible with backside biasing of the sample)

Control stability

Sample stage temperature	Stability
Base temperature (no heater control)	Not specified
<10 K	±50 mK
10 K to 100 K	±10 mK
100 K to 250 K	±10 mK
251 K to 350 K	±20 mK
351 K to 675 K	±50 mK

The 2-stage CCR allows the sample to be maintained at elevated temperature during cooldown, reducing the potential for condensation, a critical requirement for measuring organic materials. The CRX-4K is designed to accommodate wafers as large as 102 mm (4 in) in diameter, with 51 mm (2 in) diameter probable regions.

Vacuum

	Standard TPS-FRG
Pump down time	30 min (to reach $<1 \times 10^{-3}$ Torr)
Room temperature	$<5 \times 10^{-4}$ Torr
Helium base temperature	$<1 \times 10^{-5}$ Torr
Maximum temperature	$<1 \times 10^{-9}$ Torr

Cycle time:	4 h
Pump down time:	0.5 h
Station cooldown:	2 h
Station warmup:	1.5 h

Vibration at sample: $<1 \mu\text{m}$

Sample

Maximum sample size:	51 mm (2 in) diameter
Sample backside optical access:	Not an option
Sample rotation:	Not an option

Probing

Maximum probes:	6
Probe arm sensor:	Included for monitoring probe temperature
Cooled probe mounts:	<20 K with sample at base temperature
Probe mount:	Thermally anchored to sample stage
Probe arm:	Thermally anchored to radiation shield
DC/RF probes:	Electrical isolation >100 G Ω for low leakage measurements
Microwave probes:	Frequency range DC up to 67 GHz for RF measurements
Fiber optic probes:	Available for electro-optical measurements
Probe landing:	All probes can land at single point in a 25 mm (1 in) diameter circle

Cryogen consumption

Room to base temperature (total):	Not required
Helium at 5 K:	Not required

¹ Base temperature assumes heat load for probes thermally anchored as listed in probing section

Station details

Temperature equipment

Sample stage sensor/heater power:	DT-670-CU-HT calibrated silicon diode/100 W
Radiation shield sensor/heater power:	DT-670C-CU silicon diode/50 W
CCR 2nd stage sensor/heater power:	DT-670A-CU silicon diode/50 W
CCR 1st stage sensor/heater power:	DT-670C-CU silicon diode/100 W
Probe arm:	DT-670C-SD silicon diode (on one probe arm)/no active control

Electronics console:	
Temperature controllers:	Two Model 336s
Helium transfer line:	Not required

Included sample holder: Removable SH-1.25-G, 31.8 mm (1.25 in) maximum sample size, grounded

Station footprint: 800 mm (31.5 in) width \times 670 mm (26.4 in) depth (does not include console or CCR compressor)

Vacuum chamber

Material:	Electroless nickel-plated aluminum
Overall size:	280 mm (11 in) outer diameter \times 140 mm (5.5 in) tall
Chamber access:	229 mm (9 in) diameter opening
Viewport:	63.5 mm (2.50 in) diameter fused quartz
Viewing area:	54.0 mm (2.13 in) diameter
Pump port:	NW 40 with included vacuum isolation valve
Gauge port:	NW 25
Gas port:	0.25 in NPT with valve
Over pressure safety:	3.5 kPa (0.5 psi) pressure relief valve

Radiation shielding

Material:	Electroless nickel-plated aluminum
Sample access:	132 mm (5.2 in) diameter lid
Viewport:	50 mm (1.97 in) diameter IR absorbing window
Viewing area:	50 mm (1.97 in) diameter

Included kits

Tool kit:	Included tools for standard operation
Spares kit:	Included kit for common consumable items
Probe starter kit:	ZN50R-25-W (qty 2), ZN50R-25-BECU (qty 2), and ZN50R-CVT-25-W (qty 2) for training

Utilities

1-phase voltage:	100/120/220/240 VAC (+5%, -10%), 50/60 Hz
1-phase power:	2 kVA recommended
3-phase voltage (CCR):	200 VAC (50/60 Hz) or 380/400/415 VAC 50 Hz or 480 VAC 60 Hz
3-phase power (CCR):	6.6 to 6.9 kW at 50 Hz/ 7.5 to 7.8 kW at 60 Hz
Cooling water power dissipation (CCR):	8.5 kW max; 6.9 kW steady state at 50 Hz; 9.0 kW max; 7.8 kW steady state at 60 Hz

Approval All instruments CE marked

Optional configurations

See pages 26–29 for option descriptions

HT High temperature (PS-HTSTAGE)

 12:1 microscope (PS-Z12)

Options

See page 26 for description

 Ring magnet kit (PS-RING-MAG-KIT)

CRX-VF



Cryogen-free vertical field superconducting magnet probe station

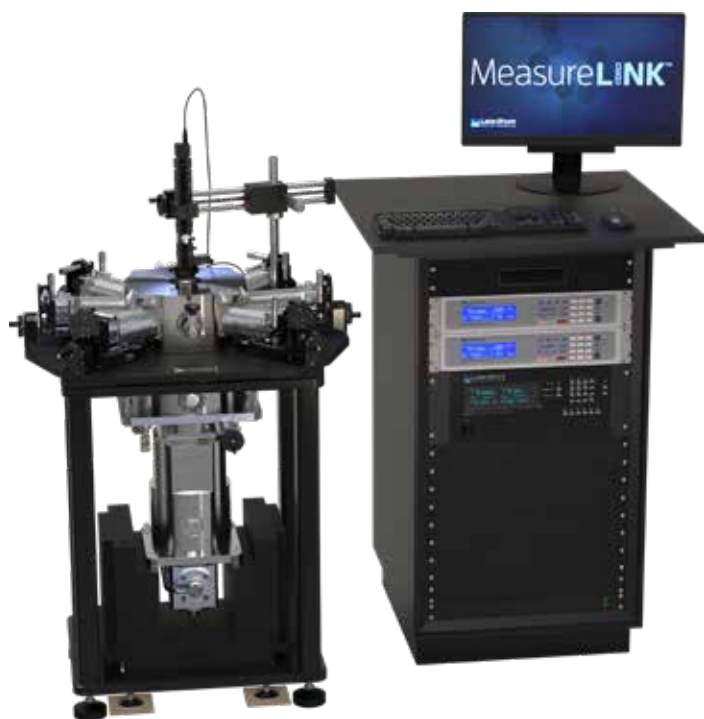

- Cryogen-free operation
- Allows unsupervised cooldown
- Standard probing plus out-of-plane vertical field superconducting magnetic measurements
- True 90° probing
- Customizable up to 3 T with specialized probes
- Version with integrated Hall measurement capabilities available (8425)

The CRX-VF is a cryogen-free, closed-cycle refrigerator probe station enhanced with a ± 2.5 T vertical field superconducting magnet. It performs C-V, I-V, microwave, and electro-optical probing, plus out-of-plane vertical field superconducting magnetic measurements. Researchers can use the CRX-VF for performing Hall effect measurements and testing magneto-transport parameters. It is designed to enable true 90° wafer probing on wafers up to 51 mm (2 in) in diameter. The sample is maintained at elevated temperature during cooldown, reducing the potential for condensation, a critical requirement for measuring organic materials.

Using a self-contained closed cycle refrigerator (CCR), the CRX-VF cools down to cryogenic temperatures unassisted, eliminating the need for monitoring by the researcher. It operates over a standard range of 10 K to 420 K. This station is the solution for those looking for the convenience of cryogen-free operation and the dependable measurement performance of a Lake Shore product.

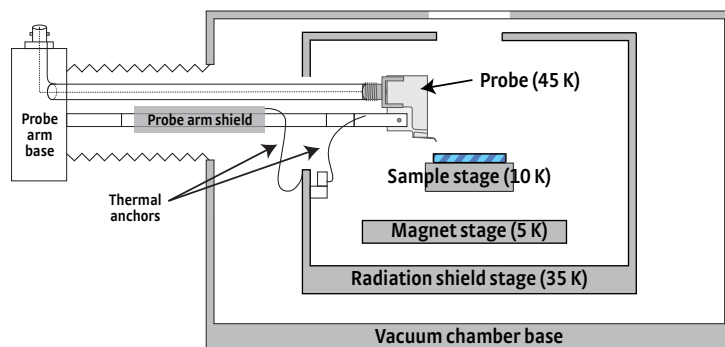

Description and specification

Sample cooling assembly

Type: 3-stage (sample + magnet + radiation shield)
 Radiation shielding: Magnet radiation shield; main radiation shield with top viewport surrounds sample
 Cooling source: 2-stage closed cycle refrigerator (CCR) with 1 W cooling power at 4.2 K

Magnetic field

Magnet type: Superconducting solenoid
 Field orientation: Vertical (perpendicular to the sample plane)
 Field control: Current control
 Field capability: ± 25 kOe (± 2.5 T) maximum
 Field homogeneity: 0.5% over 10 mm diameter; 1.0% over 25 mm diameter
 Landed probe tip movement: $< 5 \mu\text{m}$ full field ramp

Temperature

Magnetic field	Temperature range	Configuration
± 2.5 T	10 K	Up to 6 probe arms installed
± 2 T	10 K to 400 K	
± 1 T	400 K to 420 K	

Control stability

Sample stage temperature	Stability
Base temperature (no heater control)	Not specified
< 10 K	± 50 mK
10 K to 100 K	± 10 mK
100 K to 250 K	± 10 mK
251 K to 350 K	± 10 mK
351 K to 420 K	± 10 mK

Vacuum

	Standard TPS-FRG	PS-HV-CPX option
Pump down time	90 min (to reach $< 1 \times 10^{-3}$ Torr)	30 min (to reach $< 1 \times 10^{-3}$ Torr)
Room temperature	$< 5 \times 10^{-4}$ Torr	$< 5 \times 10^{-6}$ Torr
Base temperature	$< 1 \times 10^{-5}$ Torr	$< 5 \times 10^{-7}$ Torr
Maximum temperature	$< 1 \times 10^{-5}$ Torr	$< 5 \times 10^{-7}$ Torr

Cycle time: 8.5 h
 Pump down time: 1.5 h
 Station cooldown: 5 h
 Station warmup: 2 h

Vibration at sample: <1 μm

Sample

Maximum sample size: 51 mm (2 in) diameter
Sample backside optical access: Not an option
Sample rotation: Not an option

Probing

Maximum probes: 6
Probe arm sensor: Included for monitoring probe temperature
Cooled probe mounts: <50 K with sample at base temperature
Probe mount: Thermally anchored to radiation shield
Probe arm: Thermally anchored to radiation shield
DC/RF probes: Electrical isolation >100 G Ω for low leakage measurements
Microwave probes: Frequency range DC up to 67 GHz for RF measurements
Fiber optic probes: Available for electro-optical measurements
Probe landing: All probes can land at single point in a 25 mm (1 in) diameter circle

Cryogen consumption

Room to base temperature (total): Not required
Helium at 5 K: Not required

Need a CRX-VF probe station that includes advanced Hall measurement capabilities?

Add our optional PS-HM-8425 package to bring all of the DC Hall measurement capabilities of our 8400 Series Hall system to your CRX-VF station.



It includes all the instrumentation and data acquisition/analysis software for facilitating Hall voltage, Hall coefficient, Hall mobility, resistance, I-V curve, and other measurements.

Identify carriers of materials by their excitation energies and gain an understanding of dominating mechanisms, whether for Hall bar geometries or for performing gated Hall bar measurements. Use it, for instance, to measure multilayer Hall structures as part of device development.

Perform non-destructive Hall measurements of wafer-scale materials at DC fields to 2 T and variable temperatures from 10 K to 400 K within the tightly controlled CRX-VF vacuum environment—ideal for probing minute Hall structures that are prone to contamination, reactive to air, or might require initial warming to drive out moisture.

For more information, including specifications, see the PS-HM-8425 webpage at www.lakeshore.com.

Station details

Temperature equipment

Sample stage sensor/heater power: TG-120-CU-HT calibrated GaAs/50 W
Magnet stage sensor/heater power: CX-1030-CU calibrated Cernox[®]/100 W
Radiation shield sensor/heater power: DT-670C-CU silicon diode/50 W
CCR 2nd stage sensor/heater power: DT-670A-CU silicon diode/no active control
CCR 1st stage sensor/heater power: DT-670C-CU silicon diode/100 W
Probe arm: DT-670C-SD silicon diode (on one probe arm)/no active control

Electronics console:
Temperature controllers: Two Model 336s
Magnet power supply: Model 625
Helium transfer line: Not required

Included sample holder: Removable SH-1.25-G, 31.8 mm (1.25 in) maximum sample size, grounded

Station footprint: 800 mm (31.5 in) width \times 670 mm (26.4 in) depth (does not include console or CCR compressor)

Vacuum chamber

Material: Electroless nickel-plated aluminum
Overall size: 280 mm (11 in) outer diameter \times 270 mm (10.6 in) tall
Chamber access: 229 mm (9 in) diameter opening
Viewport: 63.5 mm (2.50 in) diameter fused quartz
Viewing area: 54.0 mm (2.13 in) diameter
Pump port: NW 40 with included vacuum isolation valve
Gauge port: NW 25
Gas port: 0.25 in NPT with valve
Over pressure safety: 3.5 kPa (0.5 psi) pressure relief valve

Radiation shielding

Material: Electroless nickel-plated aluminum
Sample access: 203 mm (8 in) diameter lid
Viewport: 50 mm (1.97 in) diameter IR absorbing window
Viewing area: 50 mm (1.97 in) diameter

Included kits

Tool kit: Included tools for standard operation
Spares kit: Included kit for common consumable items
Probe starter kit: ZN50R-25-W (qty 2), ZN50R-25-BECU (qty 2), and ZN50R-CVT-25-W (qty 2) for training

Utilities

1-phase voltage: 100/120/220/240 VAC (+5%, -10%), 50/60 Hz
1-phase power: 2 kVA recommended
3-phase voltage (CCR): 200 VAC (50/60 Hz) or 380/400/415 VAC 50 Hz or 480 VAC 60 Hz
3-phase power (CCR): 6.6 to 6.9 kW at 50 Hz/7.5 to 7.8 kW at 60 Hz
Cooling water power dissipation (CCR): 8.5 kW max; 6.9 kW steady state at 50 Hz; 9.0 kW max; 7.8 kW steady state at 60 Hz

Approval All instruments CE marked

Optional configurations

See pages 26–29 for option descriptions

 **Load lock (PS-LL-CPX)**

 **12:1 microscope (PS-Z12)**

 **High vacuum (PS-HV-CPX)**

CRX-EM-HF

Cryogen-free horizontal field electromagnet probe station

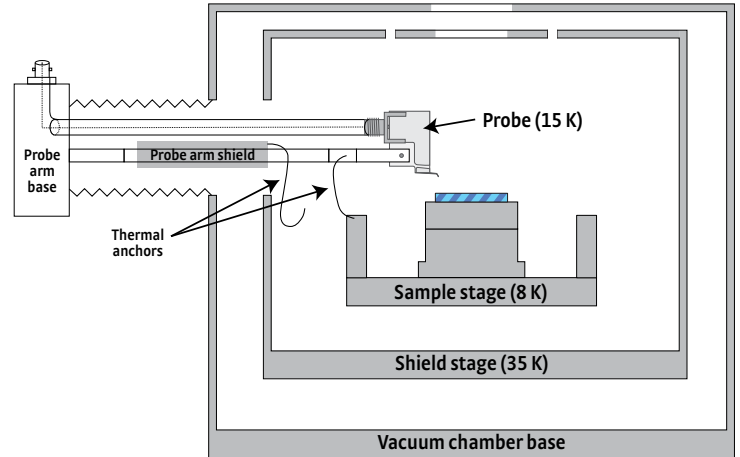

- Cryogen-free operation
- Allows unsupervised cool down
- Standard probing plus in-plane horizontal field electromagnetic measurements
- Generate full field without cooldown
- Probes configured at 30° angles to accommodate electromagnet
- Optional 360° rotation

The Lake Shore CRX-EM-HF probe station is a cryogen-free closed cycle refrigerant probe station with a ± 0.6 T horizontal, in-plane electromagnet. All standard C-V, I-V, microwave, and electro-optical probing, plus in-plane horizontal field electromagnetic measurements can be performed on this versatile probe station. Researchers can use the CRX-EM-HF for testing magneto-transport parameters. It is Lake Shore's premier cryogen-free probe station for vector-dependent magneto-transport measurements. To maximize magnetic field at the sample, the CRX-EM-HF has its probes configured at 30° angles for probing wafers up to 25 mm (1 in) in diameter.

Description and specification

Sample cooling assembly

Type: 2-stage (sample + radiation shield)
 Radiation shielding: Radiation shield with top viewport surrounds sample
 Cooling source: 2-stage closed cycle refrigerator (CCR) with 1 W cooling power at 4.2 K

Magnetic field

Magnet type: Electromagnet
 Field orientation: Horizontal (parallel to the sample plane)
 Field control: Hall probe installed in station for closed loop control
 Field capability: ± 6 kOe (± 0.6 T)
 Field homogeneity: 0.6% over 10 mm diameter; 2.6% over 25 mm diameter
 Landed probe tip movement: < 5 μ m full field ramp

Temperature¹

Base temperature	Control range	Configuration
8 K	10 K to 420 K	Up to 4 probe arms installed

Control stability

Sample stage temperature	Stability
Base temperature (no heater control)	Not specified
< 10 K	± 50 mK
10 K to 100 K	± 20 mK
101 K to 250 K	± 20 mK
251 K to 350 K	± 20 mK
351 K to 420 K	± 50 mK

Using a self-contained closed cycle refrigerator (CCR), the CRX-EM-HF cools down to cryogenic temperatures unassisted, eliminating the need for monitoring by the researcher. A 360° sample stage rotation option allows measurement of angular-dependent and anisotropic magneto-transport properties.

Vacuum

	Standard TPS-FRG
Pump down time	30 min (to reach $<1 \times 10^{-3}$ Torr)
Room temperature	$<5 \times 10^{-4}$ Torr
Helium base temperature	$<1 \times 10^{-5}$ Torr
Maximum temperature	$<5 \times 10^{-4}$ Torr

Cycle time: 4.5 h
Pump down time: 0.5 h
Station cooldown: 2.25 h
Station warmup: 1.75 h

Vibration at sample: $<1 \mu\text{m}$

Sample

Maximum sample size: 25.4 mm (1 in) diameter
Sample backside optical access: Not an option
Sample rotation: Optional 360° rotation stage (PS-360-EMPX)

Probing

Maximum probes: 4 (see orientation diagram)
Adjacent probe proximity: Due to the orientation of the probe arms, adjacent probes have minimum landing distance. Contact Lake Shore for additional information.
Probe arm sensor: Included for monitoring probe temperature
Cooled probe mounts: <20 K with sample at base temperature
Probe mount: Thermally anchored to sample stage
Probe arm: Thermally anchored to radiation shield
DC/RF probes: Electrical isolation >100 GΩ for low leakage measurements
Microwave probes: Frequency range DC up to 67 GHz for RF measurements
Fiber optic probes: Available for electro-optical measurements
Probe landing: All probes can land at single point in a 25 mm (1 in) diameter circle

Cryogen consumption

Room to base temperature (total): Not required
Helium at 5 K: Not required

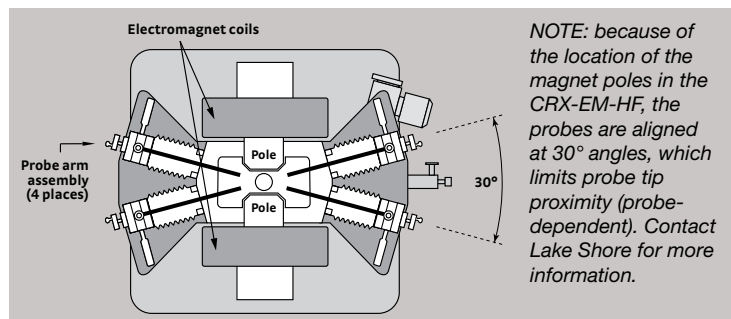

¹ Base temperature assumes heat load for probes thermally anchored as listed in probing section

Station details

Temperature equipment

Sample stage sensor/heater power: CX-1050-CU-HT-1.4M/100 W
Radiation shield sensor/heater power: DT-670C-CU silicon diode/50 W
CCR 2nd stage sensor/heater power: DT-670A-CU silicon diode/50 W
CCR 1st stage sensor/heater power: DT-670C-CU silicon diode/100 W
Probe arm: DT-670C-SD silicon diode (on one probe arm)/no active control

Electronics console:
Temperature controllers: Two Model 336
Gaussmeter: Model 475
Magnet power supply: Model 643
Helium transfer line: Not required

Included sample holder: Removable SH-1.00-G-EM, 25.4 mm (1 in) maximum sample size, grounded

Station footprint: 911 mm (36 in) width × 660 mm (26 in) depth (does not include console or CCR compressor)

Vacuum chamber

Material: Electroless nickel-plated aluminum
Overall size: 191 mm (7.5 in) × 340 mm (13.4 in) × 213 mm (8.4 in) tall
Chamber access: 133.4 mm (5.25 in) × 243.2 mm (9.58 in) opening
Viewport: 63.5 mm (2.50 in) diameter fused quartz
Viewing area: 54.0 mm (2.13 in) diameter
Pump port: NW 40 with included vacuum isolation valve
Gauge port: NW 25
Gas port: 0.25 in NPT with valve
Over pressure safety: 3.5 kPa (0.5 psi) pressure relief valve

Radiation shielding

Material: Electroless nickel-plated aluminum
Sample access: 59 mm (2.3 in) × 157 mm (6.2 in)
Viewport: 50 mm (1.97 in) diameter IR absorbing window
Viewing area: 50 mm (1.97 in) diameter

Included kits

Tool kit: Included tools for standard operation
Spares kit: Included kit for common consumable items
Probe starter kit: ZN50R-25-W (qty 2), ZN50R-25-BECU (qty 2), and ZN50R-CVT-25-W (qty 2) for training



Utilities

1-phase voltage: 100/120/220/240 VAC (+5%, -10%), 50/60 Hz
1-phase power: 2 kVA recommended
3-phase voltage (CCR): 200 VAC (50/60 Hz) or 380/400/415 VAC 50 Hz or 480 VAC 60 Hz
3-phase power (CCR): 6.6 to 6.9 kW at 50 Hz; 7.5 to 7.8 kW at 60 Hz
Cooling water power dissipation (CCR): 8.5 kW max, 6.9 kW steady state at 50 Hz; 9.0 kW max, 7.8 kW steady state at 60 Hz
3-phase voltage (EM): 200/208, 220/230, 380, 400/415 VAC (±10%), 50/60 Hz
3-phase power (EM): 5.5 kVA max, 50/60 Hz
Cooling water power dissipation (EM): 5 kW max, 50/60 Hz

Approval All instruments CE marked

Optional configurations

See pages 26–29 for option descriptions

-  **12:1 microscope (PS-Z12)**
-  **360° sample rotation (PS-360-EMPX)**

Ordering information

Probe stations

TTPX	Up to 6 micro-manipulated stage 51 mm (2 in) wafer probe station
PS-100	Preconfigured 4 micro-manipulated stage TTPX probe station
CPX	Up to 6 micro-manipulated stage 51 mm (2 in) wafer configurable probe station
CPX-VF	Up to 6 micro-manipulated stage superconducting vertical field 51 mm (2 in) wafer configurable station NOTE: Available with integrated Hall measurement as custom order
EMPX-H2	Up to 4 micro-manipulated stage electromagnet horizontal field 25 mm (1 in) wafer probe station
FWPX	Up to 6 micro-manipulated stage full 102 mm (4 in) wafer probe station
CRX-6.5K	Up to 6 micro-manipulated stage low cost CCR-based, cryogen-free 51 mm (2 in) wafer probe station
CRX-4K	Up to 6 micro-manipulated stage CCR-based, cryogen-free 51 mm (2 in) wafer probe station
CRX-VF	Up to 6 micro-manipulated stage CCR-based, cryogen-free superconducting vertical field 51 mm (2 in) wafer configurable probe station; NOTE: Available with integrated Hall measurement (see PS-HM-8425 at right)
CRX-EM-HF	Up to 4 micro-manipulated stage CCR-based, cryogen-free electromagnet horizontal field 25 mm (1 in) wafer probe station

Installation and service

PS-TRAINING-3	Three days on-site operational training/verification for the Model CRX-VF—price includes travel time and expenses
PS-TRAINING	Two days on-site operational training/verification—price includes travel time and expenses
PS-TRAINING-1	Additional operational training/verification days

Micro-manipulated stages

MMS-XX	Micro-manipulated stage with thermal radiation shields, stainless steel welded bellows, and feedthrough ports—includes probe arm and base; probes, probe tips, and cables sold separately.
---------------	--

Hall measurement package for CRX-VF probe station

PS-HM-8425	Hall measurement package for CRX-VF (factory installed); enables Hall measurements over 10 K to 400 K temperature range, 2 T field over entire range, and resistance measurement capability 0.5 mΩ to 10 MΩ; includes PC with 8400 Series system software, Model 776 switch matrix, Model 142 power amplifier, KI6220 current source, KI2182A voltmeter, software keys, and 7 ZN50R-CVT-25-W-AU probes; must specify single phase (100, 120, 220 CE, 240 CE VAC) line voltage at time of order. Factory or field-installed.
-------------------	---

Sample measurement options

84-HBM	Hall bar measurement; 6 total arms required for Hall bar measurement; option provides 2 additional MMS-09 probe arms, each with cabling and probe mount; software is already enabled
84032P	Gate bias voltage measurement; includes KI6487 voltage source and SH-2.00-T-VF triaxial sample holder. For field installed add -FI.
84031	High resistance measurement from 10 kΩ up to 100 GΩ; includes software, KI6514 electrometer/ammeter, cables, and rack mount kit. For field-installed add -FI.
750QMSA	QMSA® software for advanced mobility spectrum/multi-carrier analysis
PS-HV-CPX	High vacuum kit; lowers base pressure and eliminates condensation; includes HVAC port, vacuum pump kit, and gauge
PS-Z12	12:1 microscope upgrade

Also available (consult Lake Shore for details):

Optical excitation with topside illumination of sample using UV/IR Recirculating chillers

Installation and service

HMS-TRAINING	Two days on-site training on use of system capabilities by an application specialist—price includes travel time and expenses
PS-TRAINING	Two days on-site operational training/verification—price includes travel time and expenses

Also available: Hall measurement for the CPX-VF probe station.

Each probe station comes with expanded probe starter kit comprising (2) ZN50R-CVT-25-W, (2) ZN50R-25-W, and (2) ZN50R-25-BECU probes*. For additional probes as well as DC/RF cables and more specialized probes, see the selection below.

ZN50R DC/RF probe holder

ZN50-XXX	ZN50R/ZN50R-CVT probe holder
-----------------	------------------------------

ZN50R probes (alumina ceramic blade)

ZN50R-03-W	3 μm radius, tungsten
ZN50R-10-W	10 μm radius, tungsten
ZN50R-25-W	25 μm radius, tungsten
ZN50R-03-P7	3 μm radius, Paliney 7
ZN50R-10-P7	10 μm radius, Paliney 7
ZN50R-25-P7	25 μm radius, Paliney 7
ZN50R-03-BECU	3 μm radius, beryllium copper
ZN50R-10-BECU	10 μm radius, beryllium copper
ZN50R-25-BECU	25 μm radius, beryllium copper
ZN50R-100-BECU	100 μm radius, beryllium copper
ZN50R-200-BECU	200 μm radius, beryllium copper

ZN50R CVT DC/RF probes (interchangeable with ZN50R probes)

ZN50R-CVT-25-W	25 μm tip radius, tungsten
ZN50R-CVT-25-W-AU	25 μm tip radius, gold-coated tungsten
ZN50R-CVT-10-W	10 μm tip radius, tungsten
ZN50R-CVT-25-BECU	25 μm tip radius, beryllium copper

ZN50R DC/RF cables (priced per probe arm)

ZN50C-G	Ultra-miniature cryogenic coaxial probe cable with SMA plug at probe end, BNC feedthrough, and grounded shield
ZN50C-T	Ultra-miniature cryogenic coaxial probe cable with SMA plug at probe end to 3-lug triaxial feedthrough
HMWC-XX-00K(-NM)	(Non-magnetic) hermetic semirigid microwave coaxial probe cable with K (SMA compatible) plug at probe end and K (SMA compatible) socket at feedthrough end

GSG microwave probes

GSG-050-40A-XXX	K connector, 40 GHz, 50 μm pitch
GSG-100-40A-XXX	K connector, 40 GHz, 100 μm pitch
GSG-150-40A-XXX	K connector, 40 GHz, 150 μm pitch
GSG-200-40A-XXX	K connector, 40 GHz, 200 μm pitch
GSG-250-40A-XXX	K connector, 40 GHz, 250 μm pitch
GSG-050-67A-XXX	1.85 mm connector, 67 GHz, 50 μm pitch
GSG-100-67A-XXX	1.85 mm connector, 67 GHz, 100 μm pitch
GSG-150-67A-XXX	1.85 mm connector, 67 GHz, 150 μm pitch
GSG-200-67A-XXX	1.85 mm connector, 67 GHz, 200 μm pitch
GSG-250-67A-XXX	1.85 mm connector, 67 GHz, 250 μm pitch
GSG-TPM	Planarization module with upgraded probe manipulator to accommodate microwave probe rotation mechanism for in situ probe planarization. (Included with each microwave probing configuration ordered with a probe station. When purchasing a GSG probe alone, GSGTPM is not included.)

GSG microwave cables (priced per probe arm)

HMWC-XX-00K(-NM)	Loss-less compression seal; semirigid with Teflon® dielectric (Non-magnetic) hermetic semirigid microwave coaxial probe cable with K (SMA compatible) plug at probe end and K (SMA compatible) socket at feedthrough end (for measurements to 40 GHz)
HMWC-XX-185(-NM)	(Non-magnetic) hermetic semirigid microwave coaxial probe cable with a 1.85 mm plug at probe and socket feedthrough ends (for measurements to 67 GHz)

* Probe contents differ in the PS-HM-8425 package. See description for number and types included.

Use us as a resource!

Our experts can advise you on the optimal system for your application. Get us involved early and benefit from our many years of experience.

Sample holders

Not all sample holders are compatible with every system. Each sample holder also has a system-dependent upper temperature limit (see sample holder section). Coaxial sample holders require FT-BNC; triaxial holders require FT-TRIAX.

SH-0.50-T	Triaxial sample holder for up to 13 mm (0.5 in) diameter samples
SH-1.00-G	Grounded sample holder for up to 25 mm (1 in) diameter samples
SH-1.00-C	Coaxial sample holder for up to 25 mm (1 in) diameter samples
SH-1.00-T	Triaxial sample holder for up to 25 mm (1 in) diameter samples
SH-1.00-G-EM	Grounded sample holder for up to 25 mm (1 in) diameter samples
SH-1.00-C-EM	Coaxial sample holder for up to 25 mm (1 in) diameter samples
SH-1.00-T-EM	Triaxial sample holder for up to 25 mm (1 in) diameter samples
SH-1.25-G	Grounded sample holder for up to 32 mm (1.25 in) diameter samples
SH-1.25-C	Coaxial sample holder for up to 32 mm (1.25 in) diameter samples
SH-1.25-C-VF	Coaxial sample holder for up to 32 mm (1.25 in) diameter samples
SH-1.25-T	Triaxial sample holder for up to 32 mm (1.25 in) diameter samples
SH-1.25-T-VF	Triaxial sample holder for up to 32 mm (1.25 in) diameter samples
SH-2.00-G	Grounded sample holder for up to 51 mm (2 in) diameter samples
SH-2.00-C	Coaxial sample holder for up to 51 mm (2 in) diameter samples
SH-2.00-C-VF	Coaxial sample holder for up to 51 mm (2 in) diameter samples
SH-2.00-T	Triaxial sample holder for up to 51 mm (2 in) diameter samples
SH-2.00-T-VF	Triaxial sample holder for up to 51 mm (2 in) diameter samples
SH-4.00-4G	Grounded holder for up to 102 mm (4 in) diameter samples
SH-4.00-4C	Coaxial holder for up to 102 mm (4 in) diameter samples
SH-4.00-4T	Triaxial holder for up to 102 mm (4 in) diameter samples
PS-RING-MAG-KIT	Set of 4 ring magnets with special grounded sample holder to create four different vertical B field conditions. Nominal fields are 1900 G, 1770 G, 1440 G, and 850 G. This option is compatible with the following probe stations: PS-100, TTPX, CPX, CRX-4K, and CRX-6.5K. Not compatible with probe stations using a low temperature option.
FT-BNC	Coaxial feedthrough and coaxial cable, installed and wired
FT-TRIAX	Triaxial feedthrough and coaxial cable, installed and wired

Optical access sample holders (TTPX only)

5 mm (0.2 in) diameter optical access; each requires FT-OPTIC

SH-1.25-G-0	Optical access grounded sample holder for up to 32 mm (1.25 in) diameter samples
SH-1.25-C-0	Optical access coaxial sample holder for up to 32 mm (1.25 in) diameter samples
SH-1.25-T-0	Optical access triaxial sample holder for up to 32 mm (1.25 in) diameter samples
SH-2.00-G-0	Optical access grounded sample holder for up to 51 mm (2 in) diameter samples
SH-2.00-C-0	Optical access coaxial sample holder for up to 51 mm (2 in) diameter samples
SH-2.00-T-0	Optical access triaxial sample holder for up to 51 mm (2 in) diameter samples
FT-OPTIC	Optical access kit—includes window, window holder, tower, and related components

Installed configurations

PS-PVIS	Pneumatic vibration isolation system
PS-STAND-TTPX	Heavy duty welded steel stand
PS-TTVIS	Pneumatic tabletop vibration isolation system
PS-Z12	12:1 microscope upgrade
PS-HV-CPX	High vacuum configuration
PS-LL-CPX	Load-lock assembly
PS-VLT-CPX	1.6 K temperature configuration
PS-360-EMPX	360° sample stage rotation
PS-HTSTAGE	High temperature kit (not compatible with backside sample biasing)

Options and accessories

PS-LT	Low temperature kit
PS-REF-CRX	Cernox® reference substrate
CS-5	50 µm ² calibration substrate
CS-15	25 µm ² calibration substrate
PS-PAB-XX	Spare probe arm and base
PA-SEN	Probe arm sensor configuration; must be configured with arm
GSG-TPM	Probe tip planarization module
TPS-FRG-100/120V	Compact turbo pumping system, 100/120 V
TPS-FRG-220/240V-CE	Compact turbo pumping system, 220/240 V
PS-TP-KIT	Turbo pumping kit
PS-FIBER-HOLDER	Fiber optic probe positioning fixture
PS-PLVI-40	NW 40 pump line vibration isolator
PS-PLVI-25	NW 25 pump line vibration isolator
1220-50	50 L Dewar
PS-TLF-LNA	High flow transfer line for TTPX, CPX, CPX-VF, EMPX-H2
PS-TLF-LNB	High flow transfer line for FWPX
PS-SC-CPX	Suitcase for use with load-lock assembly (PS-LL-CPX)

Parametric probe kits and accessories

PS-PARAMETRIC-KIT-QUASI-K	Quasi-Kelvin measurement kit; requires two probe arms without temperature sensors to implement 4-wire connection; contains four ZN50R probes with dual connectors and specified probe tips, two PS-PARAM-QK-CABLE, and two FT-TRIAX; not compatible with load-lock assembly or high-temperature sample stage options
PS-PARAMETRIC-KIT-CV	C-V measurement kit; contains four ZN50R probes with dual connectors and specified probe tips, one C-V cable and two triaxial-BNC adapters; not compatible with load-lock assembly or high-temperature sample stage options
PS-PARAM-QK-CABLE	Coaxial quasi-Kelvin measurement cable for parametric probes; SMA-SMBB connectors
PS-PARAM-CV-CABLE	Coaxial C-V measurement cable for parametric probes; SMBB-SMBB connectors

ZN50R parametric probes (interchangeable with ZN50R probes)

ZN50R-10-W-PARAM	10 µm tip radius, tungsten, dual connector
ZN50R-25-W-PARAM	25 µm tip radius, tungsten, dual connector
ZN50R-5-W-AU-PARAM	5 µm tip radius, Au coated tungsten, dual connector

Probe arm fiber optic modifications

PS-FOAP-SM	New fiber kit, SM fibers, 1290 to 1650 nm, 9/125 µm, FC connector, flat polish, NA 0.14; includes tower with penetrating feedthrough, fiber, and fiber holder
PS-FOAP-IRVIS	New fiber kit, IRVIS fibers, 400 to 2100 nm, 200/240 µm, SMA connector, flat polish, NA 0.22; includes tower with penetrating feedthrough, fiber, and fiber holder
PS-FOAP-UUVIS	New fiber kit, UUVIS fibers, 200 to 900 nm, 100/140 µm, SMA connector, flat polish, NA 0.22; includes tower with penetrating feedthrough, fiber, and fiber holder

Probe arm replacement fiber kits

PS-FOPH-SM	Replacement fiber kit, SM fibers, 1290 to 1650 nm, 9/125 µm, FC connector, flat polish, NA 0.14; includes tower adapter with penetrating feedthrough for installation of fiber on existing probe arm
PS-FOPH-IRVIS	Replacement fiber kit, IRVIS fibers, 400 to 2100 nm, 200/240 µm, SMA connector, flat polish, NA 0.22; includes tower adapter with penetrating feedthrough for installation of fiber on existing probe arm
PS-FOPH-UUVIS	Replacement fiber kit, UUVIS fibers, 200 to 900 nm, 100/140 µm, SMA connector, flat polish, NA 0.22; includes tower adapter with penetrating feedthrough for installation of fiber on existing probe arm

Non-ferruled fiber optic positioning fixture

PS-FIBER-HOLDER	Fiber optic probe positioning fixture
------------------------	---------------------------------------

Equipment compatibility

Model	TPPX	CPX	CPX-VF	EMPX-H2	FWPX	CRX-6.5K	CRX-4K	CRX-VF	CRX-EM-HF
Configurable probe station models (see pages 30 to 49)									
Cooling method	Flow cryogen	Flow cryogen	Flow cryogen	Flow cryogen	Flow cryogen	CCR	CCR	CCR	CCR
Magnetic field			Vertical	Horizontal				Vertical	Horizontal
Required user-configurable equipment (see pages 16 to 23)									
Maximum number of probe arms	6 (MMS-07)	6 (MMS-09)	6 (MMS-09)	4 (MMS-10)	6 (MMS-13)	6 (MMS-07)	6 (MMS-09)	6 (MMS-09)	4 (MMS-10)
DC/RF probing (see pages 16 to 19)									
50 Ω stripline probe body mount (1 required for each ZN50R probe arm)	ZN50-26U	ZN50-55I	ZN50-55I	ZN50	ZN50-55I	ZN50-26U	ZN50-55I	ZN50-55I	ZN50
ZN50R probes	Alumina ceramic blade, maximum frequency is 50 MHz with ZN50C-G or ZN50C-T cable; maximum frequency is 1 GHz with HMWC-07-00K cable. All ZN50R probes are compatible with all probe stations.								
ZN50R-CVT flexible probes	Continuously variable temperature alumina ceramic flexible blade, maximum frequency is 50 MHz with ZN50C-G or ZN50C-T cable; maximum frequency is 1 GHz with HMWC-07-00K cable. All ZN50R-CVT probes are compatible with all probe stations.								
Planarization module	GSG-TPM—recommended for use with ZN50R-CVT probes								
Shielded ZN50R measurement cable to 50 MHz	ZN50C-G	ZN50C-G	ZN50C-G	ZN50C-G	ZN50C-G	ZN50C-G	ZN50C-G	ZN50C-G	ZN50C-G
Low leakage ZN50R measurement cable to 50 MHz	ZN50C-T	ZN50C-T	ZN50C-T	ZN50C-T	ZN50C-T	ZN50C-T	ZN50C-T	ZN50C-T	ZN50C-T
Microwave measurement cable to 1 GHz ^{††}	HMWC-07-00K	HMWC-09-00K	HMWC-09-00K-NM	HMWC-10-00K-NM	HMWC-13-00K	HMWC-07-00K	HMWC-09-00K	HMWC-09-00K-NM	HMWC-10-00K-NM
Parametric probing (see page 20)									
C-V and quasi-Kelvin probing	10 or 25 μm W or 5 μm Au-W	10 or 25 μm W or 5 μm Au-W	10 or 25 μm W or 5 μm Au-W	10 or 25 μm W or 5 μm Au-W	10 or 25 μm W or 5 μm Au-W	10 or 25 μm W or 5 μm Au-W	10 or 25 μm W or 5 μm Au-W	10 or 25 μm W or 5 μm Au-W	10 or 25 μm W or 5 μm Au-W
Microwave probing (see page 22)									
GSG microwave probes	GSG-XXX-XXA-26U-E	GSG-XXX-XXA-55I-E	GSG-XXX-XXA-55I-E-NM	GSG-XXX-XXA-E-NM	GSG-XXX-XXA-55I-E	GSG-XXX-XXA-26U-E	GSG-XXX-XXA-26U-E	GSG-XXX-XXA-55I-E-NM	GSG-XXX-XXA-E-NM
Planarization module	GSG-TPM—included with each GSG probe ordered with a probe station; when purchasing a GSG probe alone, GSG-TPM is not included								
GSG microwave cable to 40 GHz	HMWC-07-00K	HMWC-09-00K	HMWC-09-00K-NM	HMWC-10-00K-NM	HMWC-13-00K	HMWC-07-00K	HMWC-09-00K	HMWC-09-00K-NM	HMWC-10-00K-NM
GSG microwave cable to 67 GHz	HMWC-07-185	HMWC-09-185	HMWC-09-185-NM	HMWC-10-185-NM	HMWC-13-185	HMWC-07-185	HMWC-09-185	HMWC-09-185-NM	HMWC-10-185-NM
Sample holders (see page 22 to 23)									
Available sample holders (one of the bolded sample holders comes with the station)	SH-1.25-G SH-1.25-I SH-1.25-C* SH-1.25-T** SH-2.00-G SH-2.00-I SH-2.00-C* SH-2.00-T** SH-1.25-G-0† SH-1.25-I-0† SH-1.25-C-0† SH-1.25-T-0† SH-2.00-G-0† SH-2.00-C-0† SH-2.00-T-0† PS-RING-MAG-KIT	SH-0.50-T** SH-1.00-G SH-1.00-I SH-1.00-C* SH-1.00-T** SH-1.25-G SH-1.25-I SH-1.25-C* SH-1.25-T** SH-2.00-G SH-2.00-I SH-2.00-C* SH-2.00-T** PS-RING-MAG-KIT	SH-1.25-G SH-1.25-I SH-1.25-C-VF* SH-1.25-T-VF** SH-2.00-G SH-2.00-I SH-2.00-C-VF* SH-2.00-T-VF**	SH-1.00-G-EM SH-1.00-I-EM SH-1.00-C-EM* SH-1.00-T-EM** (coaxial and triaxial -EM holders cannot be used with the 360°rotation option)	SH-4.00-G SH-4.00-C* SH-4.00-T**	SH-1.25-G SH-1.25-I SH-1.25-C* SH-1.25-T** SH-2.00-G SH-2.00-I SH-2.00-C* SH-2.00-T** PS-RING-MAG-KIT	SH-1.25-G SH-1.25-I SH-1.25-C* SH-1.25-T** SH-2.00-G SH-2.00-I SH-2.00-C* SH-2.00-T** PS-RING-MAG-KIT	SH-1.25-G SH-1.25-I SH-1.25-C-VF* SH-1.25-T-VF** SH-2.00-G SH-2.00-I SH-2.00-C-VF* SH-2.00-T-VF**	SH-1.00-G-EM SH-1.00-I-EM SH-1.00-C-EM* SH-1.00-T-EM** (coaxial and triaxial -EM holders cannot be used with the 360°rotation option)
Feedthrough and cable—coaxial	*FT-BNC—required with coaxial sample holders (or can use FT-TRIAX)								
Feedthrough and cable—triaxial	**FT-TRIAX—required with triaxial sample holders								
Optical access kit	† FT-OPTIC—required with optical access sample holders								

^{††}S21 > -10 dB up to 1 GHz, except for a (-40 dB) spike between 400 MHz and 800 MHz depending on probe model and placement; S11 < 3 dB up to 1 GHz

Model	TTPX	CPX	CPX-VF	EMPX-H2	FWPX	CRX-6.5K	CRX-4K	CRX-VF	CRX-EM-HF
Equipment options (see pages 26 to 29)									
360° sample stage rotation				PS-360-EMPX					PS-360-EMPX
High vacuum		PS-HV-CPX	PS-HV-CPX					PS-HV-CPX	
Hall effect measurement								PS-HM-8425	
Load-lock		PS-LL-CPX	PS-LL-CPX					PS-LL-CPX	
Load-lock suitcase		PS-SC-CPX	PS-SC-CPX					PS-SC-CPX	
Fiber optic probe arm modification	PS-FOAP-SM PS-FOAP-IRVIS PS-FOAP-UVVIS	PS-FOAP-SM PS-FOAP-IRVIS PS-FOAP-UVVIS	PS-FOAP-SM PS-FOAP-IRVIS PS-FOAP-UVVIS	PS-FOAP-SM PS-FOAP-IRVIS PS-FOAP-UVVIS	PS-FOAP-SM PS-FOAP-IRVIS PS-FOAP-UVVIS	PS-FOAP-SM PS-FOAP-IRVIS PS-FOAP-UVVIS	PS-FOAP-SM PS-FOAP-IRVIS PS-FOAP-UVVIS	PS-FOAP-SM PS-FOAP-IRVIS PS-FOAP-UVVIS	PS-FOAP-SM PS-FOAP-IRVIS PS-FOAP-UVVIS
Microscope upgrade	PS-Z12	PS-Z12	PS-Z12			PS-Z12	PS-Z12	PS-Z12	PS-Z12
High temperature sample stage	PS-HTSTAGE (not compatible with backside sample biasing)					PS-HTSTAGE (not compatible with backside sample biasing)	PS-HTSTAGE (not compatible with backside sample biasing)		
Low temperature	PS-LT	PS-LT	PS-LT	PS-LT	PS-LT				
Very low temperature		PS-VLT-CPX							
Vibration isolator—NW25	PS-PLVI-25	PS-PLVI-25	PS-PLVI-25	PS-PLVI-25	PS-PLVI-25			PS-PLVI-25	
Vibration isolator—NW40	PS-PLVI-40	PS-PLVI-40	PS-PLVI-40	PS-PLVI-40	PS-PLVI-40	PS-PLVI-40	PS-PLVI-40	PS-PLVI-40	PS-PLVI-40
Turbo pump, requires turbo pump kit	TPS-FRG-100/120V or TPS-FRG-220/240V-CE	TPS-FRG-100/120V or TPS-FRG-220/240V-CE	TPS-FRG-100/120V or TPS-FRG-220/240V-CE	TPS-FRG-100/120V or TPS-FRG-220/240V-CE	TPS-FRG-100/120V or TPS-FRG-220/240V-CE	TPS-FRG-100/120V or TPS-FRG-220/240V-CE	TPS-FRG-100/120V or TPS-FRG-220/240V-CE	TPS-FRG-100/120V or TPS-FRG-220/240V-CE	TPS-FRG-100/120V or TPS-FRG-220/240V-CE
Turbo pump kit	PS-TP-KIT	PS-TP-KIT	PS-TP-KIT	PS-TP-KIT	PS-TP-KIT	PS-TP-KIT	PS-TP-KIT	PS-TP-KIT	PS-TP-KIT
50 L nitrogen Dewar	1220-50	1220-50	1220-50	1220-50	1220-50				
Transfer line	PS-TLF-LNA	PS-TLF-LNA	PS-TLF-LNA	PS-TLF-LNA	PS-TLF-LNB				
Probe arm sensor, requires purchase of replacement probe arm/base	PA-SEN	PA-SEN	PA-SEN	PA-SEN	PA-SEN	PA-SEN	PA-SEN	PA-SEN	PA-SEN
Replacement probe arm/base	PS-PAB-07	PS-PAB-09	PS-PAB-09	PS-PAB-10	PS-PAB-13	PS-PAB-07	PS-PAB-09	PS-PAB-09	PS-PAB-10
TTPX stand	PS-STAND-TTPX								
Vibration isolation	PS-TTVIS	PS-PVIS	PS-PVIS		Included				
Cernox® reference kit	PS-REF-CRX	PS-REF-CRX	PS-REF-CRX	PS-REF-CRX	PS-REF-CRX	PS-REF-CRX	PS-REF-CRX	PS-REF-CRX	PS-REF-CRX
Calibration substrates	CS-5 CS-15	CS-5 CS-15	CS-5 CS-15	CS-5 CS-15	CS-5 CS-15	CS-5 CS-15	CS-5 CS-15	CS-5 CS-15	CS-5 CS-15
Required installation/training and service									
3-day CRX-VF training								PS-TRAINING-3	
2-day training	PS-TRAINING	PS-TRAINING	PS-TRAINING	PS-TRAINING	PS-TRAINING	PS-TRAINING	PS-TRAINING		PS-TRAINING
Required additional day								PS-TRAINING-1	
Additional day, if necessary	PS-TRAINING-1	PS-TRAINING-1	PS-TRAINING-1	PS-TRAINING-1	PS-TRAINING-1	PS-TRAINING-1	PS-TRAINING-1		PS-TRAINING-1

How to configure a probe station

1 Select the probe station base model

See the systems overview on page 14. More detailed specifications for each system are on pages 30 to 47.

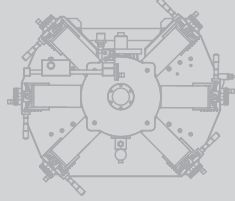

2 Select the desired number of probe arms

Probe stations may be configured with one arm up to the maximum arms available (either 4 or 6, depending on the model).

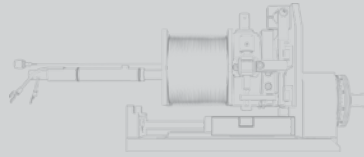

3 Select the required probe and cable types

See the different probing configurations on pages 16 to 21.

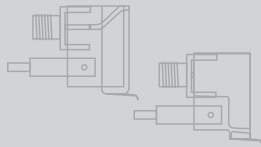

4 Select optional sample holders, if required

Sample holder types are outlined on pages 22 to 23.



5 Select other compatible options and accessories

Both installed and field-installable options are shown on pages 26 to 29.

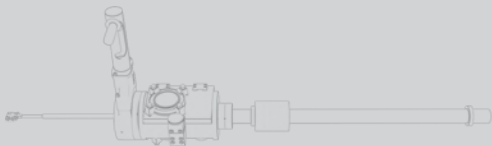

6 Add required training and installation services

Training options are in the ordering information on page 48.



Copyright © Lake Shore Cryotronics, Inc. All rights reserved. Specifications are subject to change.

Lake Shore Cryotronics, the Lake Shore logo, the square graph logomark, and Cernox are registered trademarks of Lake Shore Cryotronics, Inc.

All other trade names referenced are the service marks, trademarks, or registered trademarks of their respective companies.

071124

Lake Shore Cryotronics, Inc.
575 McCorkle Boulevard
Westerville, OH 43082 USA
Tel 614-891-2244
Fax 614-818-1600
e-mail info@lakeshore.com
www.lakeshore.com

