

User's Manual
Model 425
Gaussmeter



Lake Shore Cryotronics, Inc.
575 McCorkle Blvd.
Westerville, Ohio 43082-8888 USA

sales@lakeshore.com
service@lakeshore.com
www.lakeshore.com

Fax: (614) 891-1392
Telephone: (614) 891-2243

Methods and apparatus disclosed and described herein have been developed solely on company funds of Lake Shore Cryotronics, Inc. No government or other contractual support or relationship whatsoever has existed which in any way affects or mitigates proprietary rights of Lake Shore Cryotronics, Inc. in these developments. Methods and apparatus disclosed herein may be subject to U.S. Patents existing or applied for.

Lake Shore Cryotronics, Inc. reserves the right to add, improve, modify, or withdraw functions, design modifications, or products at any time without notice. Lake Shore shall not be liable for errors contained herein or for incidental or consequential damages in connection with furnishing, performance, or use of this material.

Rev. 1.2

P/N 119-053

25 July 2017

LIMITED WARRANTY STATEMENT

WARRANTY PERIOD: THREE (3) YEARS

1. Lake Shore warrants that products manufactured by Lake Shore (the "Product") will be free from defects in materials and workmanship for three years from the date of Purchaser's physical receipt of the Product (the "Warranty Period"). If Lake Shore receives notice of any such defects during the Warranty Period and the defective Product is shipped freight prepaid back to Lake Shore, Lake Shore will, at its option, either repair or replace the Product (if it is so defective) without charge for parts, service labor or associated customary return shipping cost to the Purchaser. Replacement for the Product may be by either new or equivalent in performance to new. Replacement or repaired parts, or a replaced Product, will be warranted for only the unexpired portion of the original warranty or 90 days (whichever is greater)..

2. Lake Shore warrants the Product only if the Product has been sold by an authorized Lake Shore employee, sales representative, dealer or an authorized Lake Shore original equipment manufacturer (OEM).

3. The Product may contain remanufactured parts equivalent to new in performance or may have been subject to incidental use when it is originally sold to the Purchaser.

4. The Warranty Period begins on the date the Product ships from Lake Shore's plant.

5. This limited warranty does not apply to defects in the Product resulting from (a) improper or inadequate installation (unless OT&V services are performed by Lake Shore), maintenance, repair or calibration, (b) fuses, software, power surges, lightning and non-rechargeable batteries, (c) software, interfacing, parts or other supplies not furnished by Lake Shore, (d) unauthorized modification or misuse, (e) operation outside of the published specifications, (f) improper site preparation or site maintenance (g) natural disasters such as flood, fire, wind, or earthquake, or (h) damage during shipment other than original shipment to you if shipped through a Lake Shore carrier.

6. This limited warranty does not cover: (a) regularly scheduled or ordinary and expected recalibrations of the Product; (b) accessories to the Product (such as probe tips and cables, holders, wire, grease, varnish, feed throughs, etc.); (c) consumables used in conjunction with the Product (such as probe tips and cables, probe holders, sample tails, rods and holders, ceramic putty for mounting samples, Hall sample cards, Hall sample enclosures, etc.); or, (d) non-Lake Shore branded Products that are integrated with the Product.

7. To the extent allowed by applicable law, this limited warranty is the only warranty applicable to the Product and replaces all other warranties or conditions, express or implied, including, but not limited to, the implied warranties or conditions of merchantability and fitness for a particular purpose. Specifically, except as provided herein,

Lake Shore undertakes no responsibility that the products will be fit for any particular purpose for which you may be buying the Products. Any implied warranty is limited in duration to the warranty period. No oral or written information, or advice given by the Company, its Agents or Employees, shall create a warranty or in any way increase the scope of this limited warranty. Some countries, states or provinces do not allow limitations on an implied warranty, so the above limitation or exclusion might not apply to you. This warranty gives you specific legal rights and you might also have other rights that vary from country to country, state to state or province to province.

8. Further, with regard to the United Nations Convention for International Sale of Goods (CISG,) if CISG is found to apply in relation to this agreement, which is specifically disclaimed by Lake Shore, then this limited warranty excludes warranties that: (a) the Product is fit for the purpose for which goods of the same description would ordinarily be used, (b) the Product is fit for any particular purpose expressly or impliedly made known to Lake Shore at the time of the conclusion of the contract. (c) the Product is contained or packaged in a manner usual for such goods or in a manner adequate to preserve and protect such goods where it is shipped by someone other than a carrier hired by Lake Shore.

9. Lake Shore disclaims any warranties of technological value or of non-infringement with respect to the Product and Lake Shore shall have no duty to defend, indemnify, or hold harmless you from and against any or all damages or costs incurred by you arising from the infringement of patents or trademarks or violation or copyrights by the Product.

10. THIS WARRANTY IS NOT TRANSFERRABLE. This warranty is not transferrable.

11. Except to the extent prohibited by applicable law, neither Lake Shore nor any of its subsidiaries, affiliates or suppliers will be held liable for direct, special, incidental, consequential or other damages (including lost profit, lost data, or downtime costs) arising out of the use, inability to use or result of use of the product, whether based in warranty, contract, tort or other legal theory, regardless whether or not Lake Shore has been advised of the possibility of such damages. Purchaser's use of the Product is entirely at Purchaser's risk. Some countries, states and provinces do not allow the exclusion of liability for incidental or consequential damages, so the above limitation may not apply to you.

12. This limited warranty gives you specific legal rights, and you may also have other rights that vary within or between jurisdictions where the product is purchased and/or used. Some jurisdictions do not allow limitation in certain warranties, and so the above limitations or exclusions of some warranties stated above may not apply to you.

13. Except to the extent allowed by applicable law, the terms of this limited warranty statement do not exclude, restrict or modify the mandatory statutory rights applicable to the sale of the product to you.

CERTIFICATION

Lake Shore certifies that this product has been inspected and tested in accordance with its published specifications and that this product met its published specifications at the time of shipment. The accuracy and calibration of this product at the time of shipment are traceable to the United States National Institute of Standards and Technology (NIST); formerly known as the National Bureau of Standards (NBS).

FIRMWARE LIMITATIONS

Lake Shore has worked to ensure that the Model 425 firmware is as free of errors as possible, and that the results you obtain from the instrument are accurate and reliable. However, as with any computer-based software, the possibility of errors exists.

In any important research, as when using any laboratory equipment, results should be carefully examined and rechecked before final conclusions are drawn. Neither Lake Shore nor anyone else involved in the creation or production of this firmware can pay for loss of time, inconvenience, loss of use of the product, or property damage caused by this product or its failure to work, or any other incidental or consequential damages. Use of our product implies that you understand the Lake Shore license agreement and statement of limited warranty.

FIRMWARE LICENSE AGREEMENT

The firmware in this instrument is protected by United States copyright law and international treaty provisions. To maintain the warranty, the code contained in the firmware must not be modified. Any changes made to the code is at the user's risk. Lake Shore will assume no responsibility for damage or errors incurred as result of any changes made to the firmware.

FIRMWARE LICENSE AGREEMENT CONTINUED

Under the terms of this agreement you may only use the Model 425 firmware as physically installed in the instrument. Archival copies are strictly forbidden. You may not decompile, disassemble, or reverse engineer the firmware. If you suspect there are problems with the firmware, return the instrument to Lake Shore for repair under the terms of the Limited Warranty specified above. Any unauthorized duplication or use of the Model 425 firmware in whole or in part, in print, or in any other storage and retrieval system is forbidden.

TRADEMARK ACKNOWLEDGMENT

Many manufacturers and sellers claim designations used to distinguish their products as trademarks. Where those designations appear in this manual and Lake Shore was aware of a trademark claim, they appear with initial capital letters and the TM or [®] symbol.

LabVIEW[™] is a trademark of National Instruments.

Microsoft Windows[®], Windows XP[®] and Windows Vista[®] are registered trademarks of Microsoft Corporation in the United States and other countries.

WinZip[™] is a trademark of Nico Mak of Computing, Inc.

Teflon[®] is a registered trademark of E.I. DuPont de Nemours and Co. Manganin[®] is a registered trademark of Isabellenhütte Heuster GmbH & Co.

Copyright 2010-2017 Lake Shore Cryotronics, Inc. All rights reserved. No portion of this manual may be reproduced stored in a retrieval system, or transmitted, in any form or by any means, electronic, mechanical, photocopying, recording, or otherwise, without the express written permission of Lake Shore.



EU DECLARATION OF CONFORMITY



This declaration of conformity is issued under the sole responsibility of the manufacturer.

Manufacturer:

Lake Shore Cryotronics, Inc.
575 McCorkle Boulevard
Westerville, OH 43082
USA

Object of the declaration:

Model(s): 425
Description: Gaussmeter

The object of the declaration described above is in conformity with the relevant Union harmonization legislation:

2014/35/EU Low Voltage Directive
2014/30/EU EMC Directive
2011/65/EU RoHS Directive

References to the relevant harmonized standards used to the specification in relation to which conformity is declared:

EN 61010-1:2010
Overvoltage Category II
Pollution Degree 2

EN 61326-1:2013
Class A
Controlled Electromagnetic Environment

EN 50581:2012

Signed for and on behalf of:

Place, Date:
Westerville, OH USA
21-JUL-2017



Scott Ayer
Director of Quality & Compliance

Table of Contents

Chapter 1 Introduction

1.1	Product Description	1
1.1.1	Throughput	1
1.1.2	DC Measurement Mode	2
1.1.3	AC Measurement Mode	2
1.2	Measurement Features	2
1.3	Instrument Probe Features	2
1.3.1	Probe Field Compensation	2
1.3.2	Probe Information	2
1.3.3	The Probe Connection	2
1.3.4	Extension Cable	3
1.3.5	Hall Effect Generators (Magnetic Field Sensors)	3
1.4	Display and Interface Features	3
1.4.1	Keypad	3
1.4.2	Alarm, Relay and Sort	3
1.4.3	Monitor Output	3
1.4.4	Computer Interface	4
1.4.5	Model 425 Rear Panel	4
1.5	Hall Probe Selection	4
1.6	Model 425 Specifications	4
1.7	Safety Summary and Symbols	5

Chapter 2 Background

2.1	General	7
2.2	Model 425 Overview	7
2.2.1	DC Measurement	7
2.2.2	AC Measurement	7
2.2.3	Monitor Output	8
2.3	Flux Density Overview	8
2.3.1	What is Flux Density?	8
2.3.2	How Flux Density (B) Differs from Magnetic Field Strength (H)	8
2.4	Hall Measurement Theory	9
2.4.1	Active Area	9
2.4.2	Temperature Coefficients	10
2.4.3	Radiation	11
2.5	Probe Considerations	12
2.5.1	Orientation	12
2.5.2	Frequency	12
2.5.3	Gradient	13
2.5.4	Probe Durability	13
2.6	Probe Accuracy Considerations	13
2.6.1	Probe Temperature	13
2.6.2	Probe Orientation	13
2.6.3	Calibration	14
2.6.4	Off-Axis Effects	14
2.6.5	Induced AC Voltage	14
2.7	Cryogenic Measurement Considerations	14
2.7.1	Thermal Stresses	14
2.7.2	Temperature Coefficients	14
2.7.3	Probe Design	15
2.8	Hall Generator	15

Chapter 3 Installation

3.1	General	17
3.2	Inspection and Unpacking	17
3.3	Rear Panel Definition	17
3.4	Line Input Assembly	18
3.4.1	Line Voltage	18
3.4.2	Power Cord	18
3.4.3	Power Switch	19
3.5	Probe Input Connection	19
3.6	Probe Handling and Operation	20
3.6.1	Probe Handling	20
3.6.2	Probe Mounting	20
3.6.3	Probe Operation	21
3.7	Auxiliary I/O Connection	22
3.8	Attaching a Hall Generator to the Model 425	23
3.8.1	Polarity	24

Chapter 4 Operation

4.1	General	25
4.2	Front Panel Description	25
4.2.1	Keypad Definition	25
4.2.2	General Keypad Operation	26
4.3	Display Definition	26
4.3.1	Display Units	27
4.3.2	Display Annunciators	27
4.4	Display Setup	27
4.4.1	Field Units Parameter	27
4.4.2	Display Contrast	27
4.5	DC and RMS Measurement Modes	27
4.5.1	DC Measurement Mode	28
4.5.1.1	Filter	28
4.5.1.2	DC Operation Zero Probe	28
4.5.2	AC Measurement Modes	29
4.5.2.1	Narrow Band Mode	30
4.5.2.2	Wide Band Mode	30
4.5.3	Autorange and Range Selection	30
4.5.4	Max Hold Function	31
4.5.5	Max Reset Function	31
4.5.6	Relative Mode	31
4.6	Locking and Unlocking the Keypad	32

Chapter 5 Advanced Operation

5.1	General	33
5.2	The Alarm and Relay Functions	33
5.2.1	Low and High Alarm Setpoints	33
5.2.2	Magnitude and Algebraic Parameter	33
5.2.3	Inside and Outside Parameter	34
5.2.4	Alarm Sort Parameter	34
5.2.5	Alarm Audible Parameter	34
5.2.6	Relay	34
5.2.7	Alarm and Relay Examples	35
5.2.7.1	Testing and Sorting of Discrete Magnets	35
5.2.7.2	Testing a Magnet Installed in an Assembly	36
5.2.7.3	Monitoring a Static Field	36
5.3	Monitor Output	37
5.4	Probe Management	37
5.4.1	Probe Serial Number	38
5.4.2	Field Compensation	38
5.4.3	Extension Cable	38
5.4.4	Clear Zero Probe Calibration	38
5.5	Hall Generator	39
5.5.1	User Programmable Cable	39
5.5.2	Ohms Measurement Mode	39

Chapter 6 Computer Interface Operation

6.1	General	41
6.2	USB Interface	41
6.2.1	Physical Connection	41
6.2.2	Hardware Support	41
6.2.3	Installing the USB Driver	42
6.2.3.1	Installing the Driver From Windows® Update in Windows Vista® ..	42
6.2.3.2	Installing the Driver From Windows® Update in Windows® XP	42
6.2.3.3	Installing the Driver From the Internet	42
6.2.3.4	Installing the USB Driver from the Included CD-ROM	44
6.2.4	Communication	45
6.2.4.1	Character Format	45
6.2.4.2	Message Strings	45
6.2.5	Message Flow Control	46
6.3	Command Summary	46
6.3.1	Interface Commands	47

Chapter 7 Probes and Accessories

7.1	General	55
7.2	Models	55
7.3	Accessories	55
7.4	Rack Mounting	56
7.5	Probe Accessories	57
7.6	Hall Generator	57

**Chapter 8
Service**

8.1 General	59
8.2 General Troubleshooting	59
8.3 USB Troubleshooting	59
8.3.1 New Installation	59
8.3.2 Existing Installation No Longer Working	59
8.3.3 Intermittent Lockups	60
8.4 Line Voltage	60
8.5 Factory Reset Menu	60
8.5.1 Default Values	60
8.5.2 Product Information	61
8.6 Error Messages	61
8.7 Rear Panel Connector Definitions	61
8.8 Calibration Procedure	63
8.9 Firmware Updates	63
8.9.1 Updating the Firmware	63
8.9.2 Record of Updates Made to the Firmware	63
8.10 Technical Inquiries	63
8.10.1 Contacting Lake Shore	63
8.10.2 Return of Equipment	64
8.10.3 RMA Valid Period	64
8.10.4 Shipping Charges	64
8.10.5 Restocking Fee	64

Chapter 1: Introduction



FIGURE 1-1 Model 425 front view

1.1 Product Description

Features:

- Field ranges from 350 mG to 350 kG
- DC measurement resolution to 4³/₄ digits (1 part of ±35,000)
- Basic DC accuracy of ±0.20%
- DC to 10 kHz AC frequency
- USB interface
- Large liquid crystal display
- Sort function (displays pass/fail message)
- Alarm with relay
- Standard probe included
- Standard and custom probes available

Designed to meet the demanding needs of the permanent magnet industry, the Lake Shore Model 425 gaussmeter provides high end functionality and performance in an affordable desktop instrument. Magnet testing and sorting have never been easier. When used in combination with the built in relay and audible alarm features, the Model 425 takes the guesswork out of pass/fail criteria. Additional features including DC to 10 kHz AC frequency response, max hold and relative measurement make the Model 425 the ideal tool for your manufacturing, quality control and R&D flux density measurement applications. For added functionality and value, the Model 425 also includes a standard Lake Shore Hall probe. Put the Model 425 gaussmeter to use with confidence knowing it's supported by the industry leading experts in magnet measurement instrument, sensor and Hall probe technology.

1.1.1 Throughput

Throughput involves much more than just the update rate of an instrument. An intuitive menu navigation and keypad, along with overall ease of use are equally important. The Model 425 is designed with these qualities in mind. The operation is straightforward, with user display prompts to aid set-up. We understand that time is money! In addition to being user friendly, the automated magnet testing and sorting features of the Model 425 streamline sorting and testing operations. In addition, hot swapping of Hall probes allows you to switch probe types without powering the instrument off and back on. These features support increased productivity, allowing you to spend less time setting up your instrument and more time working on the task at hand.

1.1.2 DC Measurement Mode

Static or slowly changing fields are measured in DC mode. In this mode, the Model 425 uses probe field compensation to correct for probe nonlinearities, resulting in a DC accuracy to $\pm 0.20\%$. Measurement resolution is enhanced with internal filtering, allowing resolution to $4\frac{3}{4}$ digits with reading rates to 30 readings per second over the USB interface.

1.1.3 AC Measurement Mode

In addition to the DC measurement mode, the Model 425 offers an AC measurement mode for measuring periodic AC fields. The instrument provides an overall frequency range of 10 Hz to 10 kHz and is equipped with both narrow and wide band frequency modes. While in narrow band mode, frequencies above 400 Hz are filtered out for improved measurement performance.

1.2 Measurement Features

The Model 425 offers a variety of features to enhance the usability and convenience of the gaussmeter.

Autorange: in addition to manual range selection, the instrument automatically chooses an appropriate range for the measured field. Autorange works in DC and AC measurement modes.

Probe zero: allows you to zero all ranges while in DC mode with the simple push of a key.

Display units: field magnitude can be displayed in units of G, T, Oe, and A/m with resistance in Ω .

Max hold: the instrument stores and displays the captured maximum DC or AC field reading.

Relative reading: the relative mode calculates the difference between a live reading and the relative setpoint to highlight deviation from a known field point. This feature can be used in DC or AC measurement modes.

Instrument calibration: Lake Shore recommends an annual recalibration schedule for all precision gaussmeters. Recalibrations are always available from Lake Shore, but the Model 425 allows you to field calibrate the instrument if necessary. Recalibration requires a computer interface and precision low resistance standards of known value.

1.3 Instrument Probe Features

The Model 425 offers the best measurement performance when used along with Lake Shore Hall probes. Firmware-based features work in tandem with the probe's calibration and programming to ensure accurate, repeatable measurements and ease of setup. Many of the features require probe characteristics that are stored in the probe connector's non-volatile memory.

1.3.1 Probe Field Compensation

The Hall effect devices used in gaussmeter probes produce a near linear response in the presence of a magnetic field. The small nonlinearities present in each individual device can be measured and subtracted from the field reading. Model 425 probes are calibrated in a way to provide the most accurate DC readings.

1.3.2 Probe Information

The gaussmeter reads the probe information on power up or any time the probe is changed to allow hot swapping of probes. Critical probe information can be viewed on the front panel and read over the computer interface to ensure proper system configuration.

1.3.3 The Probe Connection

The Model 425 is only half the magnetic measurement equation. For the complete solution, Lake Shore offers a full complement of standard and custom Hall effect probes in a variety of sizes and sensitivities. One of ten standard Hall probes is included with the Model 425. Refer to page 5 for details on the Hall probes you can choose to receive with the Model 425.

1.3.4 Extension Cable

The complex nature of Hall effect measurements makes it necessary to match extension cables to the probe when longer cables are needed. Keeping probes and their extensions from getting mixed up can become a problem when more than one probe is used. The Model 425 alleviates most of the hassle by allowing you to match probes to extension cables in the field. Stored information can be viewed on the front panel and read over the computer interface to ensure proper mating.

1.3.5 Hall Effect Generators (Magnetic Field Sensors)

The Model 425 will operate with a discrete Hall effect generator when a suitable probe is not available. You can program the nominal sensitivity and serial number into an optional HMCBL blank connector to provide all gaussmeter functions except field compensation. If no sensitivity information is available, the Model 425 reverts to resistance measurement.

1.4 Display and Interface Features

The Model 425 has a 2-line by 20-character liquid crystal display. During normal operation, the display is used to report field readings and give results of other features such as max or relative. When setting the instrument parameters, the display gives you meaningful prompts and feedback to simplify operation.

Following are four examples of the various display configurations:

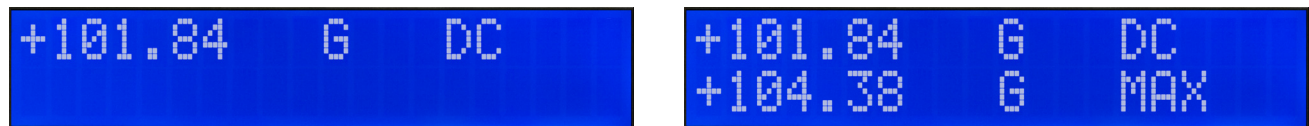

FIGURE 1-2 *Left: Normal reading—the default mode with the display of the live DC field reading; Right: Max DC hold on—the maximum value is shown in the lower display while the upper display contains the live DC field reading;*

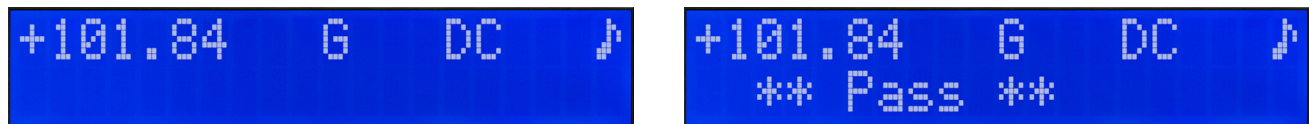

FIGURE 1-3 *Left: Alarm on—the alarm gives an audible and visual indication of when the field value is selectively outside or inside a user specified range; The relay can be associated with the alarm; Right: Sort on—the live reading is shown in the upper display while the lower display contains the pass/fail (repetitive sorting or testing) message. The relay facilitates pass/fail operation*

1.4.1 Keypad

The instrument keypad has 14 keys with individual keys assigned to frequently used features. Menus are reserved for less frequently used setup operations. The keypad can be locked out to prevent unintended changes of instrument setup.

1.4.2 Alarm, Relay and Sort

High and low alarm functions and one relay are included with the instrument, and can be used to automate repetitive magnet testing and sorting operations. Alarm actuators include display annunciator, audible beeper, and a relay. The alarm can be configured to display a pass or fail message and the relay can be configured to activate a mechanism to separate parts that meet pre-set fail criteria. The relay can also be controlled manually for other system needs.

1.4.3 Monitor Output

The monitor output provides an analog representation of the reading that is corrected for probe offset and nominal sensitivity. This feature makes it possible to view the analog signal, which has not been digitally processed. The monitor output can be connected to an oscilloscope or data acquisition system.

1.4.4 Computer Interface

The Model 425 is equipped with a universal serial bus (USB) interface. It emulates an RS-232C serial port at a fixed baud rate of 57,600, but with the physical connections of a USB. In addition to gathering data, nearly every function of the instrument can be controlled through the USB interface. The reading rate over the interface is nominally 30 readings per second. A LabVIEW™ driver is available from the download section of the Lake Shore website at www.lakeshore.com.

1.4.5 Model 425 Rear Panel

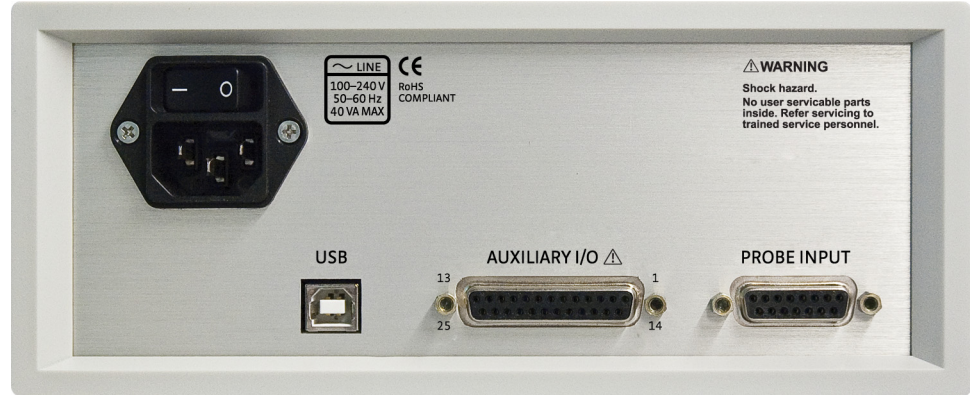

FIGURE 1-4 Model 425 rear panel showing the line input assembly, USB interface, auxiliary I/O and the probe input

1.5 Hall Probe Selection

Full details on Hall probes are provided on our website. Please see: <http://www.lakeshore.com/products/Hall-Probes/>.

1.6 Model 425 Specifications

Full specifications about the Model 425 gaussmeter are provided on our website. Please see: <http://www.lakeshore.com/products/gaussmeters/model-425-gaussmeter/pages/Specifications.aspx>.

1.7 Safety Summary and Symbols

Observe these general safety precautions during all phases of instrument operation, service, and repair. Failure to comply with these precautions or with specific warnings elsewhere in this manual violates safety standards of design, manufacture, and intended instrument use. Lake Shore Cryotronics, Inc. assumes no liability for user failure to comply with these requirements.

The Model 425 protects the operator and surrounding area from electric shock or burn, mechanical hazards, excessive temperature, and spread of fire from the instrument. Environmental conditions outside of the conditions below may pose a hazard to the operator and surrounding area.

- Indoor use
- Altitude to 2000 m
- Temperature for safe operation: 5 °C to 40 °C
- Maximum relative humidity: 80% for temperature up to 31 °C decreasing linearly to 50% at 40 °C
- Environments with conducted RF of 1 V_{rms} or EM fields of 1 V/m can cause a shift in field readings up to 10% and monitor output up to 5%
- Power supply voltage fluctuations not to exceed ±10% of the nominal voltage
- Overvoltage category II
- Pollution degree 2

Ground the Instrument

To minimize shock hazard, the instrument is equipped with a 3-conductor AC power cable. Plug the power cable into an approved 3-contact electrical outlet or use a 3-contact adapter with the grounding wire (green) firmly connected to an electrical ground (safety ground) at the power outlet. The power jack and mating plug of the power cable meet Underwriters Laboratories (UL) and International Electrotechnical Commission (IEC) safety standards.

Ventilation

The instrument has ventilation holes in its side covers. Do not block these holes when the instrument is operating.

Do Not Operate in an Explosive Atmosphere

Do not operate the instrument in the presence of flammable gases or fumes. Operation of any electrical instrument in such an environment constitutes a definite safety hazard.

Keep Away from Live Circuits

Operating personnel must not remove instrument covers. Refer component replacement and internal adjustments to qualified maintenance personnel. Do not replace components with power cable connected. To avoid injuries, always disconnect power and discharge circuits before touching them.

Do Not Substitute Parts or Modify Instrument

Do not install substitute parts or perform any unauthorized modification to the instrument. Return the instrument to an authorized Lake Shore Cryotronics, Inc. representative for service and repair to ensure that safety features are maintained.

Cleaning

Do not submerge instrument. Clean only with a damp cloth and mild detergent. Exterior only.













	Direct current (power line)		Equipment protected throughout by double insulation or reinforces insulation (equivalent to Class II of IEC 536—see Annex H)
	Alternating current (power line)		CAUTION: High voltages; danger of electric shock; background color: yellow; symbol and outline: black
	Alternating or direct current (power line)		CAUTION or WARNING: See instrument documentation; background color: yellow; symbol and outline: black
	Three-phase alternating current (power line)		
	Earth (ground) terminal		
	Protective conductor terminal		
	Frame or chassis terminal		
	On (supply)		
	Off (supply)		

FIGURE 1-5 Safety symbols

Chapter 2: Background

2.1 General

This chapter provides background information related to the Model 425 gaussmeter. It is intended to give insight into the benefits and limitations of the instrument and help apply the features of the Model 425 to a variety of situations. It covers flux density, Hall measurement, and probe operation. For information on how to install the Model 425, please refer to Chapter 3. Instrument operation information is contained in Chapter 4 and Chapter 5.

2.2 Model 425 Overview

The Model 425 gaussmeter is a highly configurable device with many built-in features. It offers a DC mode to measure static or slowly changing fields, two different modes to measure AC fields, narrow band and wide band, and a monitor output. Refer to section 2.2.1 and section 2.2.2 for more information on these modes. To better illustrate the capabilities of the gaussmeter, refer to the Model 425 system block diagram, FIGURE 2-1.

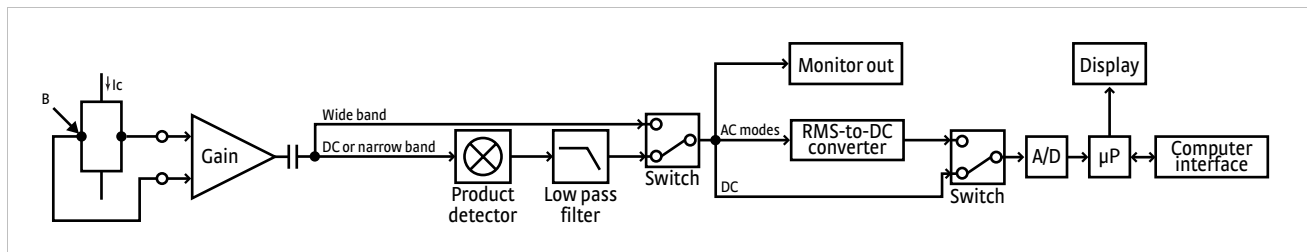

FIGURE 2-1 Model 425 system block diagram

2.2.1 DC Measurement

When in DC mode, the instrument uses a 100 mA, 5.4 kHz square wave excitation current. The voltage that is generated by the Hall sensor goes through an AC coupled programmable gain stage. From there it passes through the product detector for demodulation, a low pass filter, and the A/D converter. The digitized data is then sent to the microprocessor. The monitor output will provide a DC voltage proportional to the measured DC field. Refer to section 4.5.1 for the procedure to set the DC measurement mode. Refer to section 5.3 for information on monitor output.

2.2.2 AC Measurement

Narrow band mode: in this mode, the instrument uses a 100 mA, 5.4 kHz square wave excitation current. This type of excitation provides the benefit of noise cancellation characteristics of the product detector, but it limits the maximum field frequency of the Model 425 to approximately 400 Hz.

The voltage that is generated by the Hall sensor goes through an AC coupled programmable gain stage. From there it passes through the product detector for demodulation, a low-pass filter, and an RMS-to-DC converter, before it is sent into the A/D converter. The digitized data is then sent to the microprocessor. The monitor output will provide an AC voltage proportional to the measured AC field. Refer to section 4.5.2.1 for the procedure to set the narrow band AC measurement mode.

Wide band mode: in this mode, the instrument uses a 100 mA, DC excitation current to drive the Hall sensor. This excitation type provides the greatest frequency range for AC RMS measurements, up to 10 kHz. Since the signal doesn't pass through the product detector and low pass filter, it has a higher noise floor than narrow band mode.

The voltage that is generated by the Hall sensor goes through an AC coupled programmable gain stage and is sent directly to an RMS-to-DC converter. The signal is then sent into the A/D converter. The digitized data is then sent to the microprocessor. The monitor output will provide an unfiltered AC voltage proportional to the measured AC field. Refer to section 4.5.2.2 for the procedure to set the AC wide band mode.

2.2.3 Monitor Output

The Model 425 has a monitor output that provides an analog representation of the reading and is corrected for probe offset and nominal sensitivity. This monitor output makes it possible to view the analog signal, which has not been digitized. The monitor output can be connected to an oscilloscope or data acquisition system for analysis.

2.3 Flux Density Overview

2.3.1 What is Flux Density?

A magnetic field can be envisioned as lines of force measured in maxwells (Mx). In the cgs system, magnetic flux (ϕ) is the Mx, where $1 \text{ Mx} = 1$ line of flux. In the SI system, magnetic flux is the weber (Wb), where: $1 \text{ Wb} = 10^8 \text{ Mx}$.

Flux density is the number of flux lines passing perpendicular through a plane of unit area (A). The symbol for flux density is B, where $B = \phi / A$. The cgs system measures flux density in gauss (G), where $1 \text{ G} = 1 \text{ Mx/cm}^2$. The SI system measures flux density in tesla (T), where $1 \text{ T} = 1 \text{ Wb/m}^2$.

Flux density is important when magnet systems concentrate flux lines into a specific area like the pole pieces of an electromagnet. Forces generated on current carrying wires like those in a motor armature are proportional to flux density. Saturation of magnetic core material is also a function of flux density.



Additional conversion factors can be found in the Appendix.

2.3.2 How Flux Density (B) Differs from Magnetic Field Strength (H)

Flux density is often confused with magnetic field strength. Magnetic field strength is a measure of the force producing flux lines. The symbol for magnetic field strength is H. In the cgs system, it is measured in oersteds (Oe). In the SI system, it is measured in amperes per meter (A/m):

$$1 \text{ Oe} = 79.58 \text{ A/m}$$

Flux density and magnetic field strength are related by the permeability (μ) of the magnetic medium. $B = \mu H$. Permeability is a measure of how well a material makes a path for flux lines.

The confusion of flux density and magnetic field strength is also related to permeability. In the cgs system, the permeability of air (of vacuum) is 1. Therefore, $1 \text{ G} = 1 \text{ Oe}$ or $B = H$ in air. Many people incorrectly assume, therefore, that in the cgs system, $B = H$ at all times. Adding to the confusion, in the SI system, permeability of air is not 1, so B is not equal to H even in air.

2.4 Hall Measurement Theory

The Hall effect is the development of a voltage across a sheet of conductor when current is flowing and the conductor is placed in a magnetic field (FIGURE 2-2).

The Hall effect was discovered by E. H. Hall in 1879 and it remained a laboratory curiosity for nearly 70 years. Finally, development of semiconductors brought Hall generators into the realm of the practical. A Hall generator is a solid state sensor with a conductor that provides an output voltage proportional to magnetic flux density. As implied by its name, this sensor relies on the Hall effect.

Electrons (the majority carrier most often used in practice) drift in the conductor when under the influence of an external driving electric field. When exposed to a magnetic field, these moving charged particles experience a force perpendicular to both the velocity and magnetic field vectors. This force causes the charging of the edges of the conductor, one side positive, the other side negative. This edge charging sets up an electric field which exerts a force on the moving electrons equal and opposite to that caused by the magnetic-field-related Lorentz force. The voltage potential across the width of the conductor is called the Hall voltage. This Hall voltage can be used in practice by attaching two electrical contacts to each of the sides of the conductor.

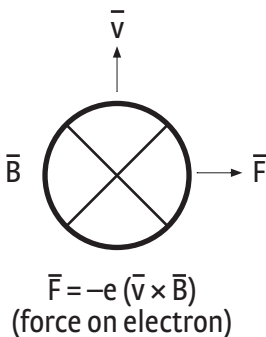

The Hall voltage can be given by the expression:

$$V_H = \gamma_B B \sin \theta$$

where: V_H = Hall voltage (mV)

γ_B = Magnetic sensitivity (mV/kG) (at a fixed current)

B = Magnetic field flux density (kG)

θ = Angle between magnetic flux vector and the plane of Hall generator.

As can be seen from the formula above, the Hall voltage varies with the angle of the sensed magnetic field, reaching a maximum when the field is perpendicular to the plane of the Hall generator.

2.4.1 Active Area

The Hall generator assembly contains the semiconductor material to which the four contacts are made. This entity is normally called a Hall plate. In its simplest form, the Hall plate is a conductor, rectangular in shape, and of fixed length, width, and thickness. Due to the shorting effect of the current supply contacts, most of the sensitivity to magnetic fields is contained in an area approximated by a circle, centered on the Hall plate, the diameter of which is equal to the plate width. This circle is considered an approximation of the active area. FIGURE 2-2 illustrates an image of the approximate active area.

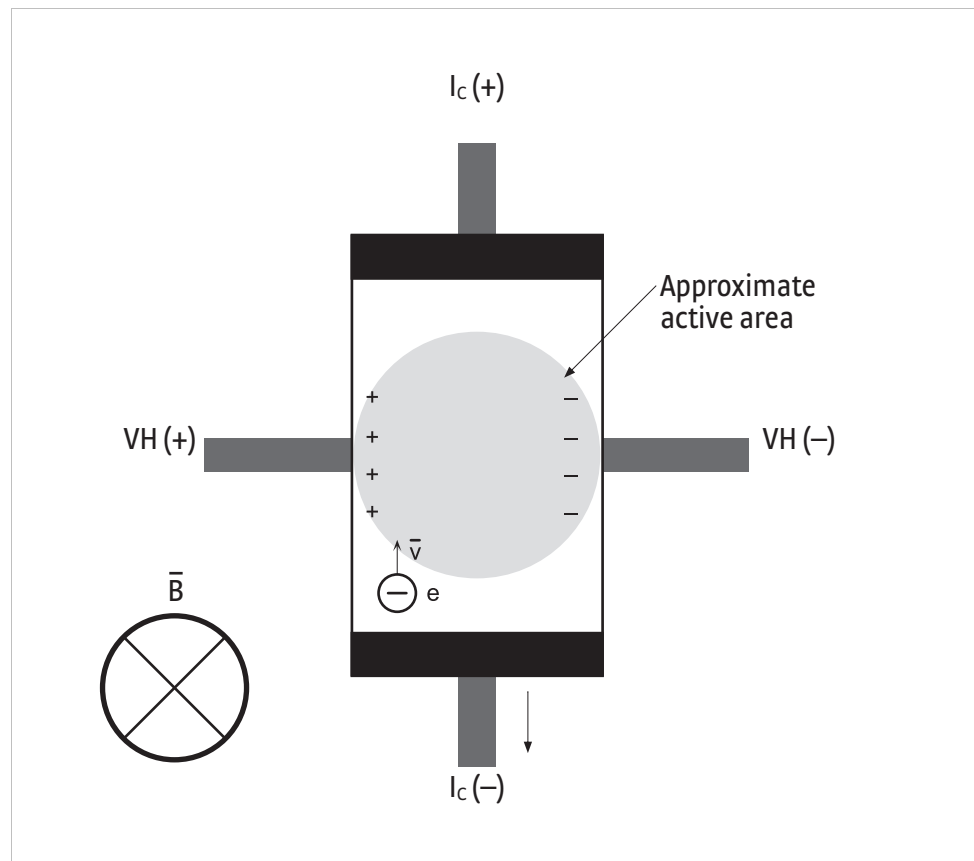

FIGURE 2-2 Approximate active area

2.4.2 Temperature Coefficients

There are two technically different temperature coefficients that always affect a gaussmeter probe: the temperature coefficient of zero and the temperature coefficient of sensitivity (section 2.4.2.1 and section 2.4.2.2). Under normal usage (reading a magnetic field), it is virtually impossible to separate the effect of each.

The Model 425 gaussmeter does not possess circuitry to allow compensation for these temperature errors. Thus, a user operating a probe in a variable temperature environment must be aware that both errors exist and what the maximum effect could be. The temperature coefficients are repeatable for an individual probe. A user can pre-measure the changes and manually correct the data for zero and sensitivity effects, or the combination of both at specific magnetic field values. The Model 425 gaussmeter also has its own temperature coefficients, which are typically less than probe coefficients. These are listed in on our website: <http://www.lakeshore.com/products/gaussmeters/model-425-gaussmeter/pages/Specifications.aspx>.

2.4.2.1 The Temperature Coefficient of Zero

The temperature coefficient of zero is a change in the zero field offset with temperature. This change is always present whether or not a field is measured. However, the temperature error caused by zero change is often the dominant source of error at magnetic field levels <100 G. If you have the ability to zero the gaussmeter at operating temperature, this coefficient is nullified and has no effect on accuracy. If the gaussmeter cannot be zeroed, then the zero change effect is present.

The unit of measure is G/°C. It is generally a fixed number, and can be either a positive or negative value. This error is specific to each probe and can be a fixed magnitude anywhere from the negative maximum to positive maximum value.

Example of zero error: assume that the Model 425 is zeroed at +25 °C and then the temperature rises to +50 °C ($\Delta T = +25$ °C). For an HMMT-6J04-VR, the worst-case zero drift would be $\pm 0.09 \text{ G}/^\circ\text{C} \times 25 \text{ }^\circ\text{C} = \pm 2.25 \text{ G}$ (maximum).



This is the maximum temperature error to be expected. Most Lake Shore probes exhibit lower temperature coefficients.

2.4.2.2 The Temperature Coefficient of Sensitivity (Calibration)

The temperature coefficient of sensitivity is related to a change in the magnetic sensitivity of the Hall device with temperature. This change is present only when a field is measured. The larger the field, the greater the error in G for the same temperature change.

This characteristic is present in all probes and is specified in units of %G/°C. The intrinsic value is always negative for Lake Shore HSE and HST probes, meaning that the sensitivity of the Hall sensor decreases with increased temperature. Therefore, the reading will be lower than the actual magnetic field when the probe is at a temperature higher than room temperature. Lake Shore Hall probes are calibrated at room temperature (25 °C); when they are used in temperatures other than this, temperature coefficient becomes another source of error. Lake Shore HST probes normally exhibit a temperature coefficient of sensitivity about ten times better (lower) than the HSE probes.



Simply handling the probe at the stem can cause sufficient temperature change of the sensor, which can cause the reading to drift; handling the probe by the stem is not recommended as it can break the probe.

Examples of sensitivity error: assume that the Model 425 is zeroed at +25 °C and then the temperature rises to +50 °C ($\Delta T = +25$ °C). For an HMMT-6J04-VR and Model 425 (no compensation), measuring a 1.000 kG field, the worst-case sensitivity change would be $-0.04\%/^\circ\text{C} \times 25 \text{ }^\circ\text{C} = -1\%$ (maximum); -1% of 1.000 kG = -10 G (reads low 10 G).

Also note that if the probe were a Model HMMT-6J04-VF, the worst case sensitivity change would be $-0.005\%/^\circ\text{C} \times 25 \text{ }^\circ\text{C} = -0.125\%$ (maximum); -0.125% of 1.000 kG = -1.25 G (reads low 1.25 G).



This is the maximum temperature error to be expected. Most Lake Shore probes exhibit lower temperature coefficients.

2.4.3 Radiation

The HST and HSE probes use a highly doped indium arsenide conductor. The HST material is the more highly doped of the two and therefore will be less affected by radiation. Some general information relating to highly doped indium arsenide Hall generators is provided in the following list. The changes in sensitivity are the maximums expected if the sensor is exposed at the given rates indefinitely.

- Gamma radiation seems to have little effect on the Hall generators
- Proton radiation up to 10 Mrad causes sensitivity changes less than 0.5%
- Neutron cumulative radiation ($>0.1 \text{ MeV}$, $10^{15} / \text{cm}^2$) can cause a 3% to 5% decrease in sensitivity

In all cases the radiation effects on the Hall sensors seem to saturate and diminish with cumulative exposure; the length of time for these effects to diminish varies depending upon radiation intensity.

2.5 Probe Considerations

This section defines and discusses things to consider when selecting a probe.

2.5.1 Orientation

Because accessing the field is part of the challenge when selecting a probe, field orientation dictates the most basic probe geometry choice of transverse versus axial. Other variations are also available for less common, more challenging applications. Listed below are the standard configurations for HSE and HST probes; UHS probes require special construction that is not described here.

- *Transverse*: most often rectangular in shape, transverse probes measure fields perpendicular to their stem width. They are useful for most general purpose field measurements and are essential for work in magnet gaps. Several stem lengths and thicknesses are available as standard probes.
- *Axial*: usually round, axial probes measure fields perpendicular to their end. They can also be used for general-purpose measurements, but are most commonly used to measure fields produced by solenoids. Several stem lengths and diameters are available as standard probes.
- *Flexible*: with a flexible portion in the middle of their stem, flexible probes have an active area at the tip that remains rigid and somewhat exposed. This unique feature makes them significantly more fragile than other transverse probes. Flexible probes should only be selected for narrow-gap measurement applications.
- *Tangential*: these probes are transverse probes designed to measure fields parallel to and near a surface. The active area is very close to the stem tip. These probes are intended for this specific application and should not be selected for general transverse measurements.



Flexible and tangential probes are significantly more fragile than other transverse probes.

- *Multiple axis*: multi-axis probes are available for multi-axis gaussmeters like the Lake Shore Model 460. These probes are not compatible with the Model 425.

2.5.2 Frequency

Hall effect gaussmeters are equally well suited for measuring either static, DC fields or periodic, AC fields, but proper probe selection is required to achieve optimal performance. HST probes are not recommended for use in wide band mode because of their lower sensitivity. These probes perform better with the the noise cancellation benefits of the narrow band mode.

- *Metal stem*: these probe stems are the best choice for DC and low frequency AC measurements. Non-ferrous metals are used for probe stems because they provide the best protection for the delicate Hall effect sensor without altering the measured field. Aluminum is the most common metal stem material, but brass can also be used. Metal stems do have one drawback: eddy currents are generated in them when they are placed in AC fields. These eddy currents oppose the field and cause measurement error. The error magnitude is proportional to frequency, and is most noticeable above 800 Hz.
- *Non-metal stem*: these probe stems are required for higher frequency AC fields and for measuring pulse fields—fiberglass/epoxy is a common non-metal stem material. Alternatively, the Hall effect sensor can be left exposed on its ceramic substrate, but provides less protection for the sensor. Eddy currents do not limit the frequency range of these non-conductive materials, but other factors may.



None of these probe types are suitable for direct exposure to high voltage. The possibility exists for damage to equipment or injury to the operator if the probe is exposed to high voltage.

2.5.3 Gradient

Probe selection would be easier if all fields were large and uniform, but most fields are limited in volume and contain gradients (changes in magnitude). Hall effect probes measure an average magnitude over their active area, making it necessary to understand the relationship between active area and field gradients.

Severe field gradients are always experienced as the active sense element is moved away from a permanent magnet pole, making it important to know the distance between the active area and probe tip. The distance between probe tip and active area is specified for axial probes, but is less easily defined for transverse probes.

- *Nominal active area:* HSE and HST probes have a nominal active area on the order of 1 mm (0.04 in) diameter, which is useful for all but the most stringent applications. The measured field is the average of the active area, but without severe gradients; therefore, the measured value accurately represents the true field. Field mapping with standard probes is also practical if a mapping resolution of 1 mm (0.04 in) or greater is acceptable.
- *Small active area:* HSE and HST probes with a smaller active area are also available from Lake Shore for measurements in severe gradients, or for high resolution mapping applications.
- *UHS probes:* UHS probes have a very large active length, up to 89 mm (3.5 in). They are designed to measure very low magnitude, large volume ambient fields with little gradient.

2.5.4 Probe Durability

All Hall effect probes are fragile. The sensor, normally located at the tip of the probe stem, must not be bent, physically shocked, or abraded. It may be tempting to choose a probe with the thinnest transverse stem or smallest diameter axial stem; however, it is always best to choose the most robust probe that fits the immediate application. For example, the HMMT-6J04-VR (aluminum stem) is less prone to damage than the HMFT-3E03-VR (flexible stem), and the HMMA-2502-VR (6.35 mm [$\frac{1}{4}$ in] diameter aluminum) is more durable than the HMNA-1904-VR (4.76 mm [$\frac{3}{16}$ in] diameter fiberglass) with its exposed Hall sensor.



Never fasten a probe stem to another object. If a probe is clamped, always apply the clamp to the handle. Improper mounting can cause damage to the probe.

2.6 Probe Accuracy Considerations

The user must consider all the possible contributors to the accuracy of the reading. Both the probe and gaussmeter have accuracy specifications that may impact the actual reading. The probe should be zeroed before making critical measurements. The zero probe function is used to null (cancel) the zero offset of the probe or small magnetic fields. It is normally used in conjunction with the zero gauss chamber, but may also be used with an open probe (registering Earth's local magnetic field). If you wish to cancel out large magnetic fields, use the relative mode (section 4.5.6).

2.6.1 Probe Temperature

Probe temperature can also affect readings. Refer to the two separate temperature coefficients listed in Chapter 1 and section 2.4.2 for an explanation of the temperature coefficients. The (HST) probes exhibit a low temperature coefficient of gain due to the inherent thermal stability of the materials used in their construction.

2.6.2 Probe Orientation

Probe readings are dependent on the angle of the sensor (Hall sensor) in relation to the magnetic field. Maximum output occurs when the flux vector is perpendicular to the plane of the sensor. This is the condition that exists during calibration at Lake Shore. The greater the deviation from orthogonality (field perpendicular to the plane of the sensor), the larger the error of the reading. For example, a 5° variance on any one axis causes a 0.4% error, a 10° misalignment induces a 1.5% error, etc. (FIGURE 3-7).

2.6.3 Calibration

Tolerance of instrument, probe, and magnet must be considered for making critical measurements. The accuracy of the gaussmeter reading is typically $\pm 0.20\%$ of reading and $\pm 0.05\%$ of range, but the absolute accuracy readings for gaussmeters and Hall probes is a difficult specification to give, because all the variables of the measurement are difficult to reproduce. Differences in alignment and positioning will degrade measurement accuracy and repeatability. Finally, the best probes have an accuracy of $\pm 0.10\%$. This implies that the combined accuracy of a magnetic field measurement will not reliably be better than $\pm 0.20\%$ of reading, and is likely to be 0.30% or higher.

2.6.4 Off-Axis Effects

In the unusual circumstance where a large off-axis field is present when making a measurement, this off-axis field generates an error. An example of this is when trying to read a small transverse field in a high field solenoid. This error occurs because there are geometric limitations in the manufacturing of the sensors. Additional errors can be caused by the planar Hall effect and magneto resistance. The amount of reading error can be as much as a few percent of this off-axis field. This is significant when the off-axis field is many times larger than the field of interest. There is no way to distinguish this error from what is the desired field reading unless the off-axis field can be eliminated.

2.6.5 Induced AC Voltage

When measuring AC fields, the stray AC fields that are present can induce a voltage on the leads which results in reading error. The effect of this error increases with frequency and proximity to the field being measured. The induced voltage can be many times greater in magnitude than the actual field being measured. Care should be taken to keep the probe stem and cables away from the field being measured to minimize this error.

2.7 Cryogenic Measurement Considerations

Magnetic field measurements are often taken in very cold environments. Conditions inside superconducting magnets and around many high-energy physics experiments involve cryogenic temperatures. Lake Shore offers two Model 425 gaussmeter probes capable of operation in temperatures down to 1.5 K ($-271.65\text{ }^\circ\text{C}$). These are the axial HMCA-2560-WN and the transverse HMCT-3160-WN (for cryogenic probe specifications, refer to the Magnetics Catalog on the Lake Shore website). Section 2.7.1 through section 2.7.3 discuss several factors that may affect either the accuracy or lifetime of these probes.

2.7.1 Thermal Stresses

Care must be taken to minimize the thermal expansion stress rate during exposure to or removal from cryogenic temperatures. If possible, allow the temperature to change at a slow rate. Sudden dipping into cryogenic liquid or removal to room temperature is not advised. Even with the greatest of care, cryogenic probes have a finite lifetime directly related to the number of times they are cycled from room temperature to cryogenic temperatures and back.

2.7.2 Temperature Coefficients

The magnitudes of the zero and sensitivity temperature coefficients (section 2.4.2.1 and section 2.4.2.2) are amplified substantially by the large temperature changes from room to cryogenic temperatures. The approximate magnitude of the error can be found in a table with the probe specifications. Refer to the magnetics catalog for details. Note that this function is not a linear relationship between room temperature and 1.5 K ($-271.65\text{ }^\circ\text{C}$).

If the gaussmeter can be zeroed after the probe reaches the final temperature, then the zero temperature coefficient is nullified. However, if zeroing is not possible at operating temperature, then its effect must be considered. Especially in low field measurements $<100\text{ G}$ (0.01 T), the zero offset change must be manually determined and recorded so it can be used for data correction.

2.7.3 Probe Design

The HMCA-2560-WN and HMCT-3160-WN probes are long, rigid tubes designed mainly for entry into Dewars through o-ring fittings. This physical configuration may not fit all applications, in particular those where the measurement volume is not in direct line with an entry port. Contact Lake Shore Applications Engineering to discuss any specific physical requirement. Special configurations are available, and new probe designs can be quoted. If probes are not suitable for your application, cryogenic Hall generators are also available.

2.8 Hall Generator

Hall probes may not be suitable in applications with size constraints or in difficult mounting situations. In these cases, Hall generators may be used. Hall generators come in different configurations and sizes. Cryogenic Hall generators are also available. Most Hall generators come with a single point sensitivity calibration that can be entered into the Model 425 (refer to section 5.5.1). Some Hall generators are available with full calibrations, but this data needs to be processed outside the Model 425; it will only use the nominal sensitivity. Refer to the Magnetics Catalog on the Lake Shore website for a list of Hall generators that are available.

Hall generators are very fragile and require delicate handling. The ceramic substrate used to produce the Hall sensor is very brittle. Use the leads to move the Hall generator. Do not handle the substrate. The strength of the lead-to-substrate bond is about 198.5 g (7 oz), so avoid tension on the leads and especially avoid bending them close to the substrate. The Hall generator is also susceptible to bending and thermal stresses.



Care must be exercised when handling the Hall generator. The device is very fragile. Stressing the Hall sensor can alter its output. Any excess force can easily break the Hall generator. Broken Hall generators are not repairable.

Chapter 3: Installation

3.1 General

This chapter provides general installation instructions for the Model 425 gaussmeter. Please read this entire chapter before installing the instrument and powering it on to ensure the best possible performance and to maintain safety. For instrument operating instructions, refer to Chapter 4 and Chapter 5. For computer interface installation and operation refer to Chapter 6.

3.2 Inspection and Unpacking

Inspect shipping containers for external damage before opening them. Photograph any container that has significant damage before opening it. Inspect all items for both visible and hidden damage that occurred during shipment. If there is visible damage to the contents of the container, contact the shipping company and Lake Shore immediately, preferably within five days of receipt of goods, for instructions on how to file a proper insurance claim. Lake Shore products are insured against damage during shipment, but a timely claim must be filed before Lake Shore will take further action. Procedures vary slightly with shipping companies. Keep all damaged shipping materials and contents until instructed to either return or discard them.

Open the shipping container and keep the container and shipping materials until all contents have been accounted for. Check off each item on the packing list as it is unpacked. Instruments themselves may be shipped as several parts. The items included with the Model 425 are listed below. Contact Lake Shore immediately if there is a shortage of parts or accessories. Lake Shore is not responsible for any missing items if not notified within 60 days of shipment.

If you need to return the instrument for recalibration, replacement or repair, a return authorization (RMA) number must be obtained from a Lake Shore representative. Refer to section 8.10.3 for the Lake Shore RMA procedure.

Probes are shipped in cardboard containers and are often included in the instrument shipping carton. Please retain the probe container for probe storage. This will help protect the delicate probe from being damaged.

Items Included with Model 425 gaussmeter:

- 1 Model 425 gaussmeter
- 1 Model 425 user's manual
- 1 I/O mating plug
- Zero gauss chamber
- 1 line power cord
- 1 line power cord for alternative voltage*

* Included only when purchased with VAC-120-ALL power option.

3.3 Rear Panel Definition

This section provides a description of the Model 425 rear panel connections. The rear panel consists of the probe input socket, auxiliary I/O socket, B-type USB connector, and the line input assembly (FIGURE 3-1). Refer to section 8.7 for rear panel connector pin-out details.



Always turn off the instrument before making the auxiliary I/O connection.

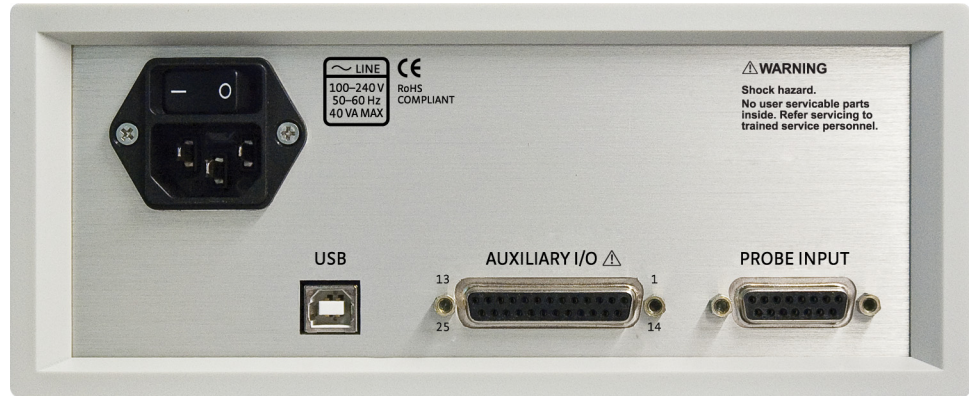

FIGURE 3-1 Model 425 rear panel

Line input assembly	Includes the IEC 320-C14 line cord receptacle and instrument power switch. Refer to section 3.4.
USB interface	Standard B-type USB connector. Refer to section 6.2 and see 8.3.
Auxiliary I/O	25-pin D-sub that provides access to the monitor output and relays. Refer to section 3.7.
Probe input	15-pin D-sub for probes or Hall generator cables. Refer to section 3.6 for additional probe considerations.

TABLE 3-1 Rear panel connector descriptions (see FIGURE 3-1 for the corresponding image)

3.4 Line Input Assembly

This section describes how to properly connect the Model 425 to line power. Please follow these instructions carefully to ensure proper operation of the instrument and the safety of operators.

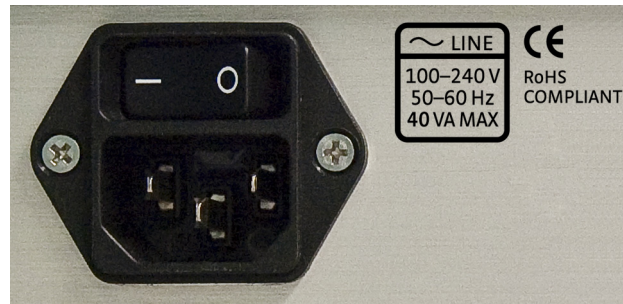

FIGURE 3-2 Line input assembly

3.4.1 Line Voltage

The Model 425 will operate between the range of 100 VAC to 240 VAC, with 50 Hz or 60 Hz configurations so that it can be operated from line power anywhere in the world. No user configuration is required for different voltage operations.

3.4.2 Power Cord

The Model 425 includes a 3-conductor power cord that mates with the IEC 320-C14 line cord receptacle. Line voltage is present on the two outside conductors, and the center conductor is a safety ground. The safety ground attaches to the instrument chassis and protects the user in case of a component failure. A CE approved power cord is included with instruments shipped to Europe; a U.S. power cord is included with all other instruments (unless otherwise specified when ordered).



Always plug the power cord into a properly grounded receptacle to ensure safe operation of the instrument.

3.4.3 Power Switch

The power switch is part of the line input assembly on the rear panel of the Model 425, and it turns line power to the instrument on and off. When the circle is depressed, power is off. When the line is depressed, power is on (FIGURE 3-2).

! CAUTION

Position the instrument so that the power switch is easily accessible.

3.5 Probe Input Connection

This section describes the probe input connection and pin-out details.

The Lake Shore Hall probe plugs into the 15-pin D-sub socket on the rear panel. Align the probe connector with the probe input socket and push straight in to avoid bending the pins. For best results, secure the connector to the rear panel using the two thumbscrews. A tight connector keeps the cable secure and prevents interference. Refer to section 3.6 for additional probe considerations.

An electrically erasable programmable read only memory (EEPROM) is included in each probe. The EEPROM stores specific information that the gaussmeter requires for operation. The information includes serial number, probe sensitivity, field compensation data, and calibration data. When a new probe is connected, the instrument reads parameters from probe memory and the probe is ready to use. A new probe can be connected at any time even while the instrument is turned on. No parameters need to be entered into the Model 425 for a Lake Shore probe. However, the zero probe function should be performed the first time a probe is used with the instrument and periodically during use (section 4.5.1.2).

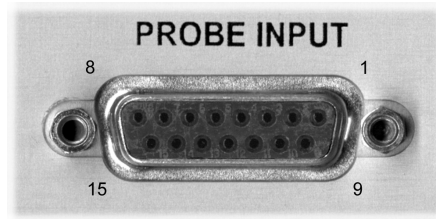

FIGURE 3-3 Probe input socket

Pin	Description	Pin	Description
1	V input +	9	V input –
2	Internal use only	10	No connection
3	Internal use only	11	EEPROM GND
4	Internal use only	12	EEPROM VCC
5	Internal use only	13	EEPROM CLK
6	Internal use only	14	EEPROM DATA
7	No connection	15	I Hall –
8	I Hall +		

TABLE 3-2 Probe input connector details

3.6 Probe Handling and Operation



To avoid damage and for best results during use, probes have a number of handling and accuracy requirements that must be observed.

Probes used with the gaussmeter have conductive parts. Never probe near exposed live voltage. Personal injury and damage to the instrument may result.

3.6.1 Probe Handling

Although every attempt has been made to make the probes as sturdy as possible, they are still fragile. This is especially true for the exposed sensor tip of some transverse probes. While taking measurements, be careful not to place pressure on the probe tip.



Care must be exercised when handling the probe. The tip of the probe is very fragile. Stressing the Hall sensor can alter its calibration. Any excess force can easily break the sensor. Broken Hall sensors are not repairable.

Avoid repeated flexing of the stem of a flexible probe. As a rule, the stem should not be bent more than 45° from the base (FIGURE 3-4). Force should never be applied to the tip of the probe. On all probes, do not pinch or allow cables to be struck by any heavy or sharp object. Although damaged or severed cables should be returned to Lake Shore for repair, understand that probes are not always repairable.

When probes are installed on the gaussmeter but are not in use, the protective tubes provided with many probes should be placed over the probe handle and stem in order to protect the tip. The cardboard and foam container that Lake Shore probes are shipped in should be retained for probe storage when the gaussmeter is not in use. For further details on available accessories and probes, refer to Chapter 7.

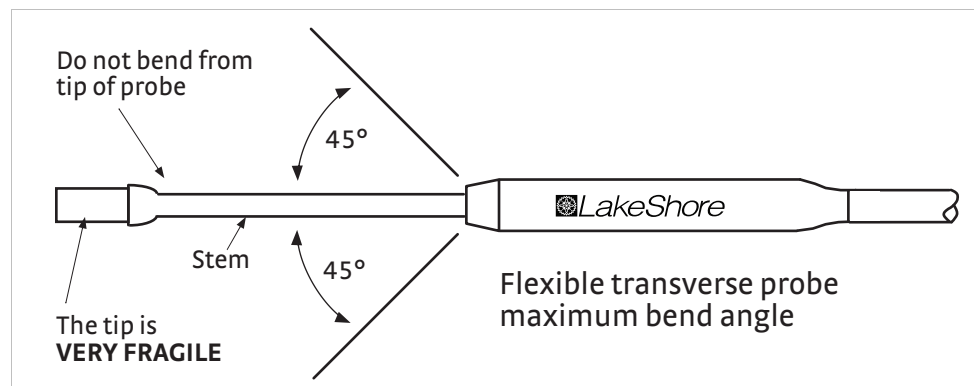

FIGURE 3-4 Maximum flexible transverse probe bend radius

3.6.2 Probe Mounting

The probe should only be held in place by securing it at the handle. Do not apply force to the probe stem. The stems are not designed to handle clamping forces. Clamping to the stem can also strain the sensor and alter the probe calibration, and excessive force may destroy the Hall sensor. Lake Shore offers two probe stands for mounting your probe. FIGURE 3-5 shows a probe properly mounted using a Lake Shore probe (P/N 4030-12 or 4030-24) stand.

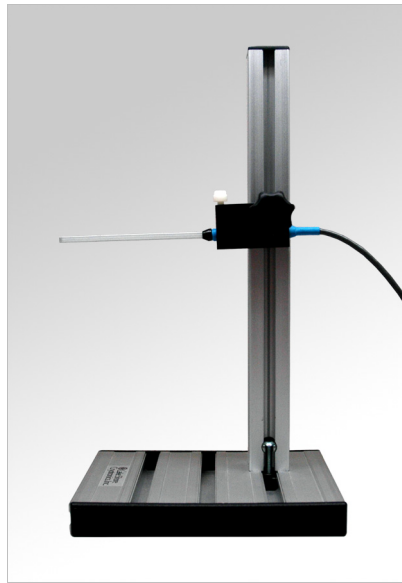

FIGURE 3-5 Proper mounting of the probe

3.6.3 Probe Operation

In the DC mode of operation, the orientation of the probe affects the polarity reading of the gaussmeter. On a transverse probe, the Lake Shore name printed on the handle indicates the side for positive (+) flux entry. On an axial probe, positive (+) flux entry is always from the front of the probe's circular face (FIGURE 3-6).

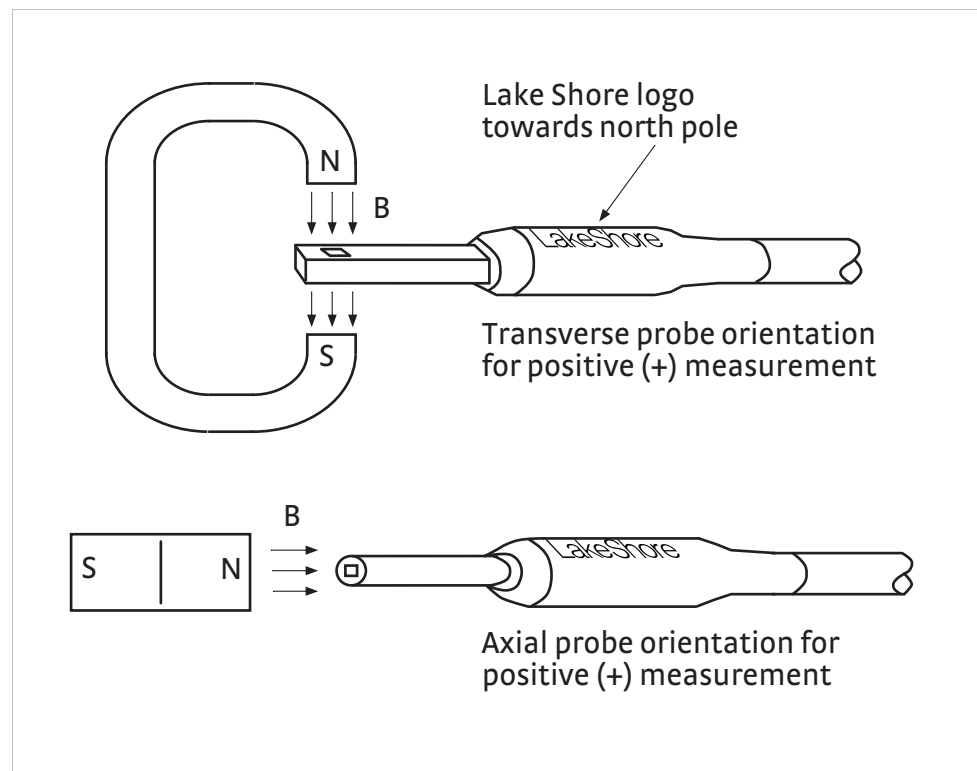

FIGURE 3-6 Probe orientation for positive measurement

NOTE

For best results, the instrument and probe should warm up for at least 5 min before zeroing the probe, and at least 30 min for rated accuracy. Also, the probe and the magnet being measured should be at the same temperature. Simply handling the magnet can cause sufficient temperature change to cause the reading to drift.

If the exact orientation of the magnetic field is unknown, the proper magnitude is determined by turning on max hold and slowly rotating the probe. As the probe turns and the measured field rises and falls, its maximum value is held on the display. Make note of the probe orientation at the maximum reading to identify the field orientation.

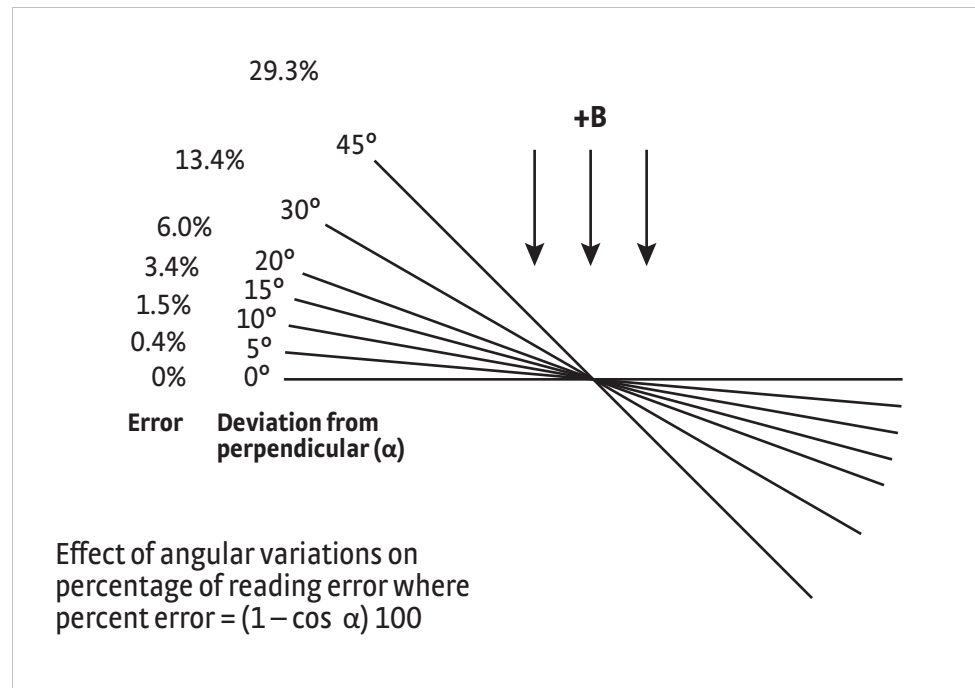

FIGURE 3-7 Effect of angle on measurements

3.7 Auxiliary I/O Connection

The auxiliary I/O connector is a 25-pin D-sub socket. This provides access to the monitor output and relays. The mating plug and connector shell are included with the Model 425. The pins are defined in TABLE 3-3.

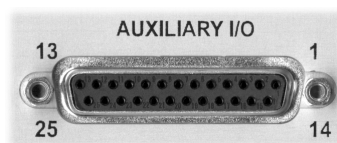

FIGURE 3-8 Auxiliary I/O socket

Pin	Description	Pin	Description
1	Monitor out	14	Ground
2	Internal use only	15	Ground
3	Internal use only	16	Ground
4	No connection	17	No connection
5	Internal use only	18	No connection
6	Internal use only	19	No connection
7	No connection	20	No connection
8	Relay 1 normally open	21	No connection
9	Relay 1 common	22	No connection
10	Relay 1 normally closed	23	No connection
11	Internal use only	24	No connection
12	Internal use only	25	No connection
13	Internal use only		

TABLE 3-3 Auxiliary I/O connector details

Monitor output: the Model 425 has a monitor output that provides an analog representation of the reading, and is corrected for probe offset and nominal sensitivity. The monitor output has an output scale of ± 3.5 V, which is proportional to the measured field on the selected range. You can connect an oscilloscope or data acquisition system to the monitor out to analyze the readings.

Relay 1: the Model 425 has one mechanical relay designated as relay 1. The relay is associated with the high and low alarms, or you can manually control it. Refer to the website (<http://www.lakeshore.com/products/gaussmeters/model-425-gaussmeter/pages/Specifications.aspx>) for voltage and current ratings for the relay. Refer to section 5.2.6 for more operational details.

3.8 Attaching a Hall Generator to the Model 425

Connecting a Hall generator to the Model 425 requires a Lake Shore Model HMCBL-6 (2 m [6 ft]) or HMCBL-20 (6 m [20 ft]) cable assembly, which are sold separately. Each Hall generator purchased from Lake Shore will come with a nominal field sensitivity value. However, we recommend that the customer always check accuracy against a reference field to verify the sensitivity value sent with the bare Hall generator. Lake Shore has no control of the installation; therefore, the user must accept responsibility for accuracy and compatibility.

In cryogenic applications, Manganin™ lead wire is frequently used because of its thermal conductivity properties. Manganin™ wire is not usually acceptable for connection to a Hall generator because the resistance of Manganin™ wire is often too high. The gaussmeter current source is limited in compliance voltage. The Model 425 should not drive a load (Hall sensor, customer leads, and cable) greater than $30\ \Omega$. In cryogenic applications, Hall generators are normally connected using twisted pairs of copper wire such as 34 AWG, Teflon® insulated wire.

The HMCBL-XX cable has a 15-pin D-sub plug on one end for direct attachment to the probe input socket on the rear panel of the Model 425 gaussmeter. The four leads, illustrated in FIGURE 3-9, correspond to the four leads on the Hall generators. The leads may be soldered directly to these wires. Once connections are made, refer to section 5.5.1 for instructions on programming parameters into the internal EEPROM.

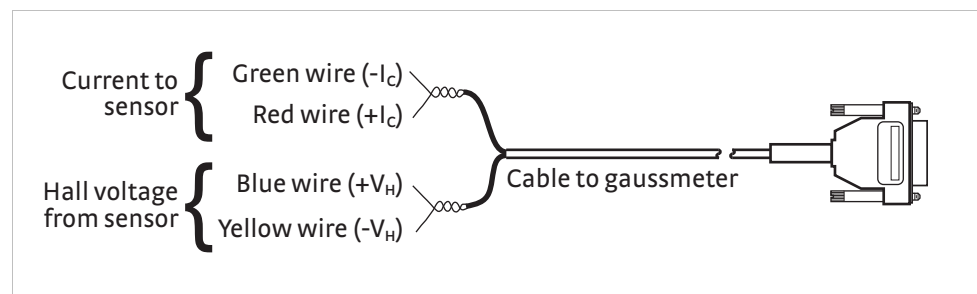

FIGURE 3-9 Model HMCBL-XX user programmable cable accessory



Accidental contact of Hall generators to hazardous live voltage can cause injury or death.



Lake Shore Hall generators are not designed for direct exposure to live voltage. Exposing the Hall generator to live voltage can cause damage to the instrument.



Refer to the Lake Shore Magnetics Catalog for a list of compatible Hall generators manufactured by Lake Shore.

3.8.1 Polarity

If the control current enters the red lead (with $+I_C$ connected to the positive terminal of the current supply), and the magnetic field direction B is as shown in section 2.4, a positive Hall voltage will be generated at the $+V_H$ lead. Reversing either the current or the magnetic field will reverse the output voltage.

Chapter 4: Operation

4.1 General

This chapter provides instructions for the general operating features of the Model 425 gaussmeter. Advanced operation including probe management is in Chapter 5. Computer interface instructions are in Chapter 6.

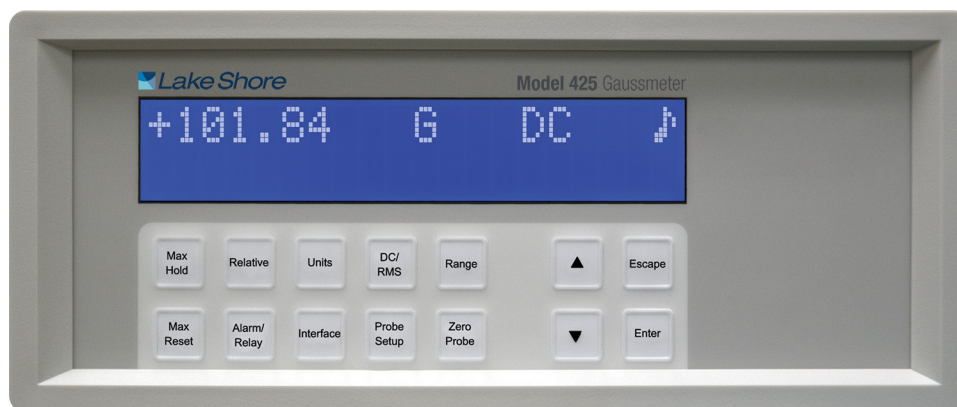

FIGURE 4-1 Model 425 front panel

4.2 Front Panel Description

This section provides a description of the front panel controls and indicators for the Model 425.

4.2.1 Keypad Definition The Model 425 has 14 keys separated into two groups on the instrument front panel.

Key	Function	Refer to section
Max Hold	Used to turn the max hold function on and off.	4.5.4
Relative	Used to turn the relative mode on and off.	4.5.6
Units	Allows configuration of the field units of measurement.	4.4.1
DC/RMS	Used to select between DC and AC root mean square (RMS) field measurement modes. Press and hold for 3 s to select filter in DC mode or to select between narrow and wide band modes in RMS mode.	4.5
Range	Allows for selection between field measurement ranges and autorange.	4.5.3
Max Reset	Resets the maximum field reading.	4.5.5
Alarm/Relay	Allows configuration of the alarm setpoints and relay. Press and hold for 3 s to configure alarm parameters.	5.2
Interface	Displays the instrument baud rate. Press and hold for 3 s to adjust the display contrast.	6.2
Probe Setup	Used to display the probe serial number and to turn field compensation on or off. Press and hold for 3 s for HMPEC/HMCBL (extension or user cable) programming.	5.4
Zero Probe	Used to zero probe offsets or null the effects of ambient low level fields. Press and hold for 3 s to clear the results of zero probe.	4.5.1.2
st	Used to navigate menus and to select settings.	4.2.2
Escape (exit menu)	Cancels a selection. Press and hold for 3 s to reset the instrument to default values, and to display the firm-ware version and the instrument serial number.	4.2.2
Enter	Used to accept a selection. Also used to navigate deeper into a menu screen. Press and hold for 3 s to lock or unlock the keypad.	4.2.2

TABLE 4-1 Keypad definitions

4.2.2 General Keypad Operation

The Model 425 uses three basic keypad operations for the majority of operator interface: direct operation, press and hold, and setting selection.

- **Direct operation:** the key feature occurs immediately when the key is pressed. **DC/RMS**, **Max Hold**, and **Relative** are examples of keys that operate this way.
- **Press and hold:** the key feature occurs when the key is pressed and held for approximately 3 s. It is used to modify less frequently changed features. This operation is described in the individual sections for keys with secondary functions available.
- **Setting selection:** allows you to select from a finite list of values. During setting selection the **s** and **t** keys are used to select a value. **Enter** is used to accept the change and advance to the next setting. **Escape** will cancel the change to that setting and return to the normal display. Setting selection screens always include the message: Select with **st**.
- **Numeric data entry:** allows you to enter numeric data using the **s** and **t** keys. Low and high alarm setpoints are examples of parameters that require numeric data entry. Press **s** or **t** to cycle through the available ranges, the +/- sign, and the numerals 0 through 9, depending on what is being entered. Press **Enter** to advance the cursor to the next position or to save the number and return from numeric data entry mode if it is in the last position. Press **Escape** to restart the number entry or cancel all changes and return from numeric data entry mode if it is at the first position.

When using numeric entry, the first parameter to be entered is the range. Choose a range that is appropriate for the number being entered. This affects both the decimal point location as well as the units multiplier. The next item to be entered is the sign of the number if the alarm function is set with the algebraic setting (section 5.2.2). The final item to be entered is the number with five digits of resolution.

Related setting selection and data entry sequences are often chained together under a single key. To bypass a feature without changing it, press **Enter** before pressing an arrow key. To return to the normal display in the middle of a setting sequence, press **Escape** before pressing an arrow key. Changes entered before **Escape** is pressed are kept.

4.3 Display Definition

This section describes features of the display that appear during normal operation. In normal operation, the two row by twenty character liquid crystal display (LCD) provides readings defined by the selected measurement features on the top row and special information or readings on the bottom row. Other information displays when using the various features on the keypad. The computer interface provides readings at a rate of 30 rdg/s, and the display will update at 3 rdg/s independent of the filter.

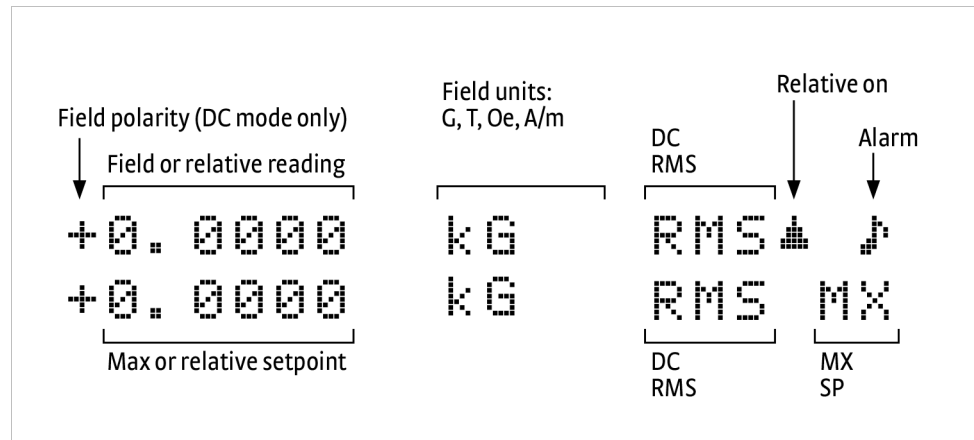

FIGURE 4-2 Front panel display definition

4.3.1 Display Units

Unit	Description
G	Field in gauss
T	Field in tesla
Oe	Field in oersted
A/m	Field in ampere/meter
Ω	Resistance in ohms

TABLE 4-2 *Display units*

4.3.2 Display Annunciators

There are display annunciators that appear as necessary to indicate additional information. Display annunciators are visible when their associated feature is enabled.

Annunciator	Function
DC, RMS	DC or RMS mode readings
MX	Indicates the max hold value; it is displayed on the lower row
°	Indicates the relative reading; it is displayed on the upper row
SP	Indicates the relative setpoint value
^a	On steady when the alarm function is on; blinks when in the alarming state
** Pass ** Fail High Fail Low	Shown when the sort parameter is enabled; indicates when a measurement passes or fails the user-specified magnet test

TABLE 4-3 *Display annunciators*

4.4 Display Setup

This section describes how to set up the field units and display contrast.

4.4.1 Field Units Parameter

The field units parameter determines which units are used to display the measured field, maximum field, and relative field readings.

Menu navigation:

Units (gauss, tesla, oersted, or ampere/meter)

Default: gauss

Interface command: **UNIT**

4.4.2 Display Contrast

The front panel LCD display contrast can be adjusted for optimal viewing. The default should work well in most standard room temperature environments, but deviations from room temperature and extreme viewing angles can cause the display contrast to require adjustment for optimal viewing.

Menu navigation:

Interface (press and hold for 3 s) → Contrast → (1 to 32)

Default: 10

Interface command: **BRIGHT**

4.5 DC and RMS Measurement Modes

The Model 425 can be configured for DC or RMS measurements. Pressing DC/RMS toggles between DC and RMS measurement modes. The DC/RMS annunciator on the display will immediately change to DC or RMS, depending on what measurement mode has been selected.

4.5.1 DC Measurement Mode

To measure static or slowly changing fields, use the DC measurement mode. In DC measurement mode, the display shows the measured DC field and the polarity (sign) followed by the appropriate field units. The resolution of DC readings is 3¾ digits when the filter function is turned off and 4¾ digits when the filter is turned on (section 4.5.1.1). The monitor output will provide a DC voltage proportional to the measured DC field, where ± 3.5 V equals \pm full scale for the selected range.

Menu navigation:

DC/RMS (toggle)

Default: DC

Interface command: `RDGMODE`

4.5.1.1 Filter

The filter is a moving average filter of 16 readings and settles in approximately 0.5 s. It is a moving average filter so it does not change the reading update rate. If the filter is turned on, all reading values are filtered including the relative reading, and all features will use the filtered reading including maximum reading and alarms. The filter has no effect on the monitor output.

The filter function is used to quiet the display and make it more readable when the probe is exposed to a noisy field. The filter also acts to quiet noise within the instrument, making an additional digit of usable resolution available, to 4¾ digits, with the filter on. Care should be taken when using the filter on changing fields because it may level off peaks and slow the response of the instrument.

In AC mode, the filter function is always active to help quiet the reading. Although the filter is active in AC, the resolution remains 3¾ digits.

Menu navigation:

In DC mode: `DC/RMS` (press and hold for 3 s) → *Filter* (on, off)

Default: on

Interface command: `RDGMODE`

4.5.1.2 DC Operation Zero Probe

The zero probe function cancels out the zero offset of the probe or small DC magnetic fields. It is normally used in conjunction with the zero gauss chamber, but may also be used with an unshielded probe (registering Earth's local magnetic field). The zero probe function should be used any time a probe is changed, when operating in conditions such as significant temperature change, and periodically during normal use. To cancel large magnetic fields, use the relative mode (section 4.5.6).

During the zero probe process, do not move the probe until the zero probe process is complete and the display returns to the normal display. If during the zero probe process, the measured offset is larger than expected, the Model 425 will display a message stating "The Measured Probe Offset Larger Than Expected". The Model 425 will continue to operate with the offset correction, but it will be up to the user to investigate the nature of the offset. If through the process of elimination you are not able to discover the reason for the offset, the error message may be an indication of a damaged probe.



The "Measured Probe Offset Larger Than Expected" message can also appear if the probe is exposed to a large magnetic field during the zero probe process. If that is the intended operation, zero the probe in the zero gauss chamber and then use the relative mode to cancel the large magnetic field.



For best results, allow the instrument and probe to warm up for at least 5 min before zeroing the probe, and at least 30 min for rated accuracy. The probe and the zero gauss chamber should be at the same temperature.

To zero the probe in the zero gauss chamber follow this procedure.

1. Allow the temperature of the probe and chamber to equalize (a large temperature discrepancy affects the quality of the calibration).
2. Carefully place the probe tip into the chamber. Orientation of the probe is not critical.
3. Begin the zeroing process by pressing **Zero Probe** and then **Enter**. A calibrating message appears on the top line along with a progress bar on the bottom line.
4. Press **Escape** at any time during the zeroing process to cancel the sequence and return to the normal display. Previous probe offset values will be retained.
5. The process is complete when the instrument returns to normal display.

Menu navigation:

Zero Probe

Interface command: **ZPROBE**

4.5.2 AC Measurement Modes

The Model 425 offers two AC measurement bands to improve the overall AC measurement performance. In narrow band mode, the instrument uses a 100 mA, 5.4 kHz square wave excitation current. This type of excitation provides the benefit of noise cancellation characteristics, but it limits maximum frequency to approximately 400 Hz. In wide band mode, the instrument uses a 100 mA, DC excitation current. This type of excitation provides the greatest frequency range for RMS measurements, up to 10 kHz, but this wide bandwidth allows more noise into the measurement. It is recommended to use the narrow band mode unless the frequencies of interest are greater than 400 Hz. The resolution in AC measurement mode is fixed at 3¾ digits.

Menu navigation:

DC/RMS (toggle)

Default: DC

Interface command: **RDGMODE**

To change between the two AC measurement bands, follow this menu navigation.

Menu navigation:

In AC mode: **DC/RMS** (press and hold for 3 s)→ (filter band narrow, filter band wide)

Default: filter band narrow

Interface command: **RDGMODE**

4.5.2.1 Narrow Band Mode

The narrow band mode has been designed to measure AC fields ranging from 10 Hz to 400 Hz. The monitor output will provide an AC voltage proportional to the measured AC field, where ± 3.5 V equals \pm full scale for the selected range.

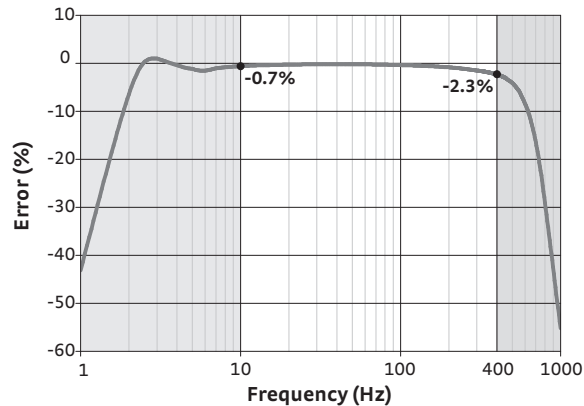

FIGURE 4-3 *Narrow band mode frequency response plot*

4.5.2.2 Wide Band Mode

The wide band mode has been designed to measure fields of higher frequencies, expanding the instrument's capability to measure AC fields ranging from 50 Hz to 10 kHz. The monitor output will provide an unfiltered AC voltage proportional to the measured AC field, where ± 3.5 V equals \pm full scale for the selected range.

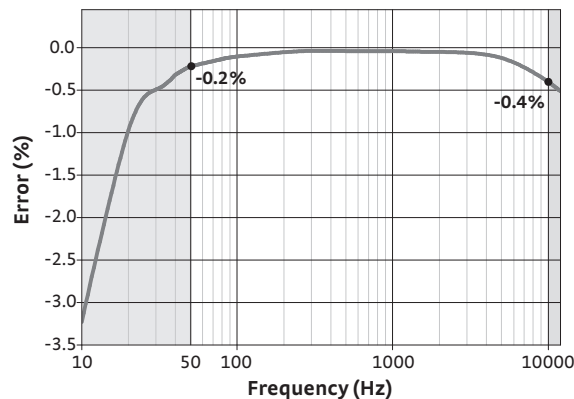

FIGURE 4-4 *Wide band mode frequency response plot*

4.5.3 Autorange and Range Selection

The Model 425 is equipped with an autoranging feature that will automatically select the appropriate field range for the measured field. In some cases it may be desirable to manually select the field range. Autorange is not recommended when measuring AC fields with a large DC background field. Autorange and manual range selection are available by pressing Range.

Menu navigation:

Range → Range (refer to TABLE 4-4)

Default: range 4 (highest)

Interface command: RANGE, AUTO

The ranges that are available depend on the probe type: high stability, high sensitivity, and ultra-high sensitivity. TABLE 4-4 lists full scale ranges for each probe sensitivity, along with the maximum number of digits of display resolution. Measurement resolution (noise floor) varies depending on probe and application.

	Gauss	Tesla	Oersted	Ampere/meter
High stability probe (HST)	±350.00 kG*	±35.000 T*	±350.00 kOe*	±28.000 MA/m*
	±35.000 kG	±3.5000 T	±35.000 kOe	±2.8000 MA/m
	±3.5000 kG	±350.00 mT	±3.5000 kOe	±280.00 kA/m
	±350.00 G	±35.000 mT	±350.00 Oe	±28.000 kA/m
High sensitivity probe (HSE)	±35.000 kG	±3.5000 T	±35.000 kOe	±2.8000 MA/m
	±3.5000 kG	±350.00 mT	±3.5000 kOe	±280.00 kA/m
	±350.00 G	±35.000 mT	±350.00 Oe	±28.000 kA/m
	±35.000 G	±3.5000 mT	±35.000 Oe	±2.8000 kA/m
Ultra-high sensitivity probe (UHS)	±35.000 G	±3.5000 mT	±35.000 Oe	±2.8000 kA/m
	±3.5000 G	±350.00 μT	±3.5000 Oe	±280.00 A/m
	±350.00 mG	±35.000 μT	±350.00 mOe	±28.000 A/m

* Accuracy for this range is not guaranteed for all HST probes

TABLE 4-4 Range and resolution for each probe type

4.5.4 Max Hold Function

The max hold function captures the maximum field reading in magnitude, with field polarity (sign) from the time when the function was turned on or from the last **Max Reset** press. For example, if the present maximum reading is +2 kG and the new reading is -3 kG, the -3 kG becomes the new maximum reading because field is larger in magnitude, and the sign only represents the direction of the field. When the max hold function is on, the active reading shows on the top line and the maximum reading shows on the bottom line.

Menu navigation:
Max Hold (toggle)
 Default: off
 Interface command: **MXHOLD**

4.5.5 Max Reset Function

If the max hold function is on and the **Max Reset** key is pressed, the maximum reading is cleared and reset with the present field reading.

Menu navigation:
 (With max hold function on) **Max Reset**
 Interface command: **MXRST**

4.5.6 Relative Mode

The relative mode allows you to take field measurements relative to a measured reference field, which acts as the relative setpoint. The relative reading is equal to the present field value minus the relative setpoint. When the relative mode is on, the relative reading will appear on the top line of the display including the small delta sign (δ) signifying the relative display. The relative setpoint is shown on the bottom line of the display.

The relative mode also interacts with other features. Relative can be used with max hold to display the maximum relative reading. If the alarm function is turned on, the instrument uses the relative reading to test for alarm conditions.

When relative mode is turned on, the present reading will be captured and made the new relative setpoint. It is also possible to manually set a new relative setpoint through the computer interface.

Menu navigation:

Relative (toggle)

Default: off

Interface command: **REL**, **RELSP**

The relative mode is turned off when the instrument is powered off and when changing between DC and RMS measurement modes.

4.6 Locking and Unlocking the Keypad

The keypad lock feature prevents accidental changes to parameter settings. When the keypad is locked, all parameter settings may be viewed, but none may be changed from the front panel. The **Max Reset** key remains active even when the keypad is locked.

When you lock the keypad, a message stating “Keypad Locked” displays for 2 s. Changes attempted to any setting result in a brief display of the “Keypad Locked” message. When you unlock the keypad, a message stating “Keypad Unlocked” displays for 2 s. You are now able to change all Model 425 parameters.

Menu navigation:

Enter (press and hold for 3 s; toggle)

Default: unlocked

Interface command: **LOCK**

Chapter 5: Advanced Operation

5.1 General

This chapter provides information on advanced operations for the Model 425 gaussmeter.

5.2 The Alarm and Relay Functions

The alarm function is commonly used to automate magnet testing and sorting in a factory environment. To configure the alarm, choose between the magnitude or algebraic setting (section 5.2.2) then choose between an inside or outside setting (section 5.2.3). To complete the alarm setup, enter your high and low alarm setpoints.

In addition to these steps, you can configure the alarm to work in a way that best suits your working conditions. For instance, while the instrument will automatically display an annunciator (A) when the alarm function is turned on, you can also choose to display a pass/fail message (section 5.2.4). Finally, the alarm can be configured to work in conjunction with the relay (section 5.2.6), which can be connected to external control equipment.

Menu navigation:
Alarm/Relay→(off, on)
 Default: off
 Interface command: **ALARM**

5.2.1 Low and High Alarm Setpoints

The alarm must be turned on in order to set the high and low alarm setpoints from the front panel. When entered, the high and low alarm setpoint values will match the field units in which the instrument is set. The range of values that can be entered are limited to ± 350 kG, independent of the probe that is attached. Refer to section 4.2.2 for numeric entry.

Menu navigation:
Alarm/Relay→(on)→*low alarm setpoint*→*high alarm setpoint*
 Default: 0
 Interface command: **ALARM**

5.2.2 Magnitude and Algebraic Parameter

The magnitude and algebraic parameter allows you to choose between testing for magnitude only (magnitude setting), or for both magnitude and field polarity (algebraic setting).

With the magnitude setting, the instrument ignores the field polarity (or sign), and instead only tests the magnitude of the field. This setting is used when orientation of the magnet is not a factor for determining whether a magnet passes or fails a magnet test.

With the algebraic setting, the instrument measures the magnitude of the field as well as field polarity. For instance, you could use the algebraic setting if you test magnets that are part of an assembly where both the orientation and magnitude are important.

Menu navigation:
Alarm/Relay (press and hold for 3 s)→(magnitude, algebraic)
 Default: magnitude
 Interface command: **ALARM**

5.2.3 Inside and Outside Parameter

The inside and outside parameter allows you to choose whether the alarm activates when the field reading is either inside or outside the user-specified setpoints. Choosing the inside setting means the alarm will activate when the reading is inside the range of the high and low setpoints. Choosing the outside setting means the alarm will activate when the reading is outside the range of the high and low setpoints. The inside and outside parameter works in conjunction with the magnitude and algebraic parameter.

Menu navigation:

Alarm/Relay (press and hold for 3 s) → *magnitude/algebraic* → *inside/outside* (inside, outside)

Default: outside

Interface command: **ALARM**

5.2.4 Alarm Sort Parameter

You can configure the Model 425 alarm to display a pass or fail message when used in repetitive magnet testing situations or sorting operations. When the sort parameter is on, pass or fail will be displayed on the lower portion of the display. When the reading is in between the high and low alarm setpoints, *****Pass***** will be shown. When the reading is outside of the setpoints, Fail High or Fail Low will be shown, depending on which setpoint the measured field has crossed. The sort message can be turned on or off as necessary and does not affect other operations of the alarm feature.

The sort parameter is dependent on the magnitude and algebraic parameter, but is independent of the inside and outside parameter. This means that *****Pass***** is always shown between the high and low setpoints.

Although it is not a typical situation for sorting operations, when the inside and outside parameter is set to inside, the instrument will show *****Pass***** when it is in the alarming state. Refer to section 5.2.7 for examples of alarm and relay.

Menu Navigation

Alarm/Relay (press and hold for 3 s) → *magnitude/algebraic* → *inside/outside* → *audible* → *sort* (on, off)

Default: off

Interface command: **ALARM**

5.2.5 Alarm Audible Parameter

The Model 425 has an audible alarm annunciator or beeper. The beeper will sound when the instrument is in an alarming state. If the beeper is not appropriate for your application, you can turn it off.

Menu navigation:

Alarm/Relay (press and hold for 3 s) → *magnitude/algebraic* → *inside/outside* → *audible* (on, off)

Default: on

Interface command: **ALARM**

5.2.6 Relay

The Model 425 has one mechanical relay that you can connect to external control equipment. It is most commonly associated with the high and low alarms, but it can be controlled manually and used for other purposes. When the instrument is powered off, the relay defaults to its normal state. The relay is rated for 30 VDC and 2 A, and its terminals are located in the auxiliary I/O socket on the Model 425 rear panel. Refer to section 8.7 for rear panel connector definitions.

The relay has two modes of operation:

- *Manual*: allows you to turn the relay off (normal) or on (active) manually from the front panel or over the computer interface.
- *Alarm*: the relay follows the operation of the alarms. You can tie the action of the relay to the high alarm, low alarm, or both alarms. The relay is activated any time the associated alarm is in an alarming state.

Menu navigation:

Alarm/Relay → alarm → low alarm setting → high alarm setting → relay (on, off, alarm)

Default: off

Interface command: **RELAY**

If the relay is in alarm mode, you can associate the relay with the high, low or both alarms. For example, if you associate the relay with the low alarm, the relay will only be activated when the low alarm setpoint is breached. If it is set to “both”, the relay will activate if either the high alarm or the low alarm setpoint is breached.

Menu navigation:

Alarm/Relay → alarm → low alarm setting → high alarm setting → relay (alarm) → (low, high, both)

Interface command: **RELAY**

5.2.7 Alarm and Relay Examples

Section 5.2.7.1 and section 5.2.7.2 describe some common applications where the alarm function can be used. Although the alarm can be used in a variety of applications, these examples provide an overview of how the alarm features can be used together.

5.2.7.1 Testing and Sorting of Discrete Magnets

A common application in magnet manufacturing is testing magnets after they have been magnetized. In this example, the unmagnetized material comes down the assembly line and enters the magnetizer. After it is magnetized, it continues to a QC area where it is tested for field strength. An operator places the magnet into a fixture where the Model 425 is used to measure the flux density. The magnet can be placed in the fixture with the north pole facing either up or down.

In this application, the alarm should be setup with the magnitude setting since the orientation is not a factor. The inside setting will be used with the audible setting on so that the instrument sounds when the measured field is within tolerance. This will give the operator an audible signal that the magnet passed the test. In this example, the alarm sort parameter is chosen to also show a pass or fail condition on the Model 425 display. The low alarm setpoint will be set to 0.9 kG (0.09 T) and the high alarm setpoint will be set to 1.1 kG (0.11 T). The beeper will sound and the display will indicate a *****Pass***** condition if the magnet has a field magnitude between the two setpoints regardless of field polarity. If the field magnitude is less than 0.9 kG the display will indicate Fail Low, and if it is greater than 1.1 kG it will indicate Fail High. Since the alarm is configured with the magnitude setting, a reading between -0.9 kG and -1.1 kG will also indicate a *****Pass***** condition since the orientation is not a factor in this scenario.

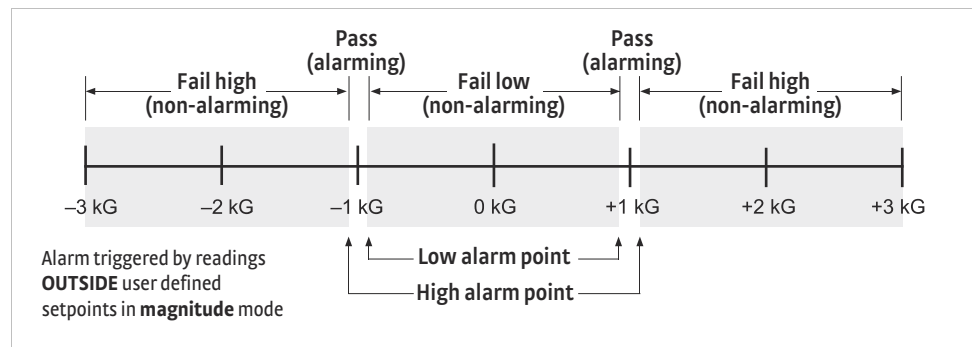

FIGURE 5-1 Alarm on with magnitude and outside settings

5.2.7.2 Testing a Magnet Installed in an Assembly

Another common application is testing magnets installed into an assembly. In this case, the orientation of the magnet matters. An example of this is the magnets used in a motor assembly. In this instance, finished magnets are installed into a motor assembly, and then they are verified using the Model 425 to measure the field magnitude and field polarity.

In this example, the alarm function will be setup the same as the previous example with the exception of using the algebraic setting instead of the magnitude setting. The algebraic setting is chosen since the orientation matters in this application. The low setpoint will be set to 0.9 kG, and the high setpoint will be set to 1.1 kG. After the assembly is placed on the test fixture, if the measured field is between the high and low alarm setpoints, the part is considered conforming, and the display will indicate a *****Pass***** condition. If the measured field is -1.0 kG, the assembly is non-conforming and the display will indicate Fail Low. In this case, the magnitude of the field was correct, but the magnet was installed with the wrong orientation.

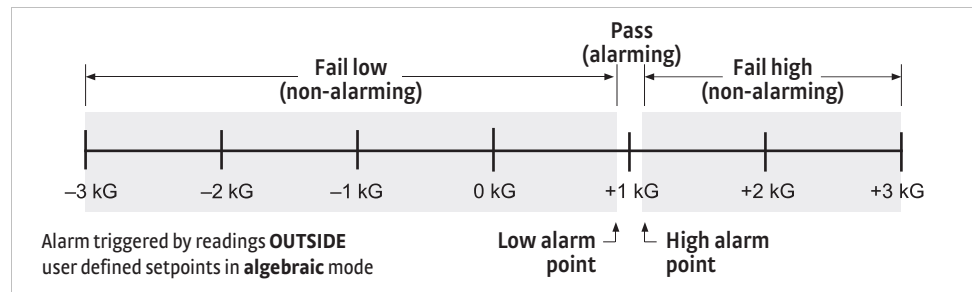

FIGURE 5-2 Alarm on with algebraic and outside settings

5.2.7.3 Monitoring a Static Field

In this application, an electromagnet is used to generate a static field for an experiment. This field is monitored using the Model 425. The results of the experiment are valid only if the field remains stable within ± 0.05 kG. If the field deviates beyond this amount, the Model 425 will alarm indicating that the experimental results are no longer valid. The relay will signal external equipment to shut down the experiment.

In this example, the alarm will be setup using the algebraic setting and the outside setting. The experiment will be done at a field of 1 kG. The low alarm setpoint will be set to 0.95 kG and the high alarm setpoint will be set to 1.05 kG. The relay will be setup to follow both alarms. If the field remains between the two setpoints, the instrument is not in an alarming state and the relay remains deactivated. If the field goes higher than 1.05 kG or lower than 0.95 kG, then the instrument will alarm and the relay will activate and shut down the experiment.

5.3 Monitor Output

The Model 425 provides a monitor output that can be connected to an oscilloscope or data acquisition system. The monitor output function provides a voltage proportional to the measured field, where ± 3.5 V equals \pm full scale for the selected range. It is corrected for nominal probe sensitivity and probe offset, but it is not corrected for probe non-linearities. The monitor output function is always enabled. To use it, connect your measurement device to the monitor output terminals on the rear panel as defined in FIGURE 8-1.

The monitor output has two different frequency responses, depending on how the instrument is set up. In DC mode and RMS narrow band mode, the monitor output has the frequency response shown in FIGURE 5-3. The output will work down to DC levels but rolls off above 400 Hz due to the product detector filter. This filter exists to reduce high frequency noise generated by the 5.4 kHz carrier. Refer to section 2.2 for a system block diagram.

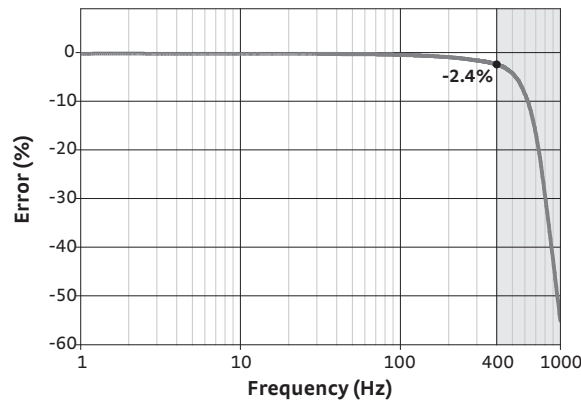

FIGURE 5-3 Monitor output DC and narrow band mode frequency response

In RMS wide band mode, the monitor output has a frequency response shown in FIGURE 5-4. Here the frequency responds up to 10 kHz, but rolls off below 50 Hz because the input is AC coupled.

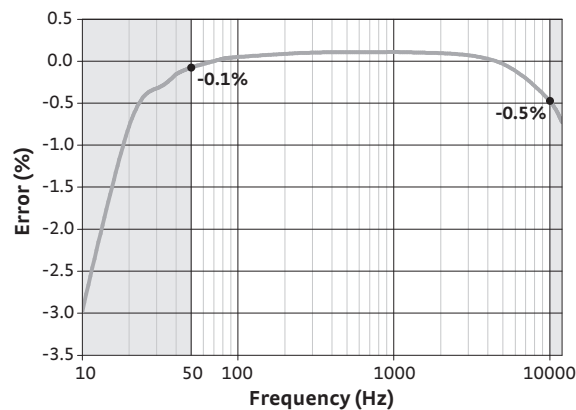

FIGURE 5-4 Monitor output wide band mode frequency response

5.4 Probe Management

The Model 425 has several capabilities that allow the best possible measurements with Lake Shore probes. These firmware-based features work in tandem with probe calibration and programming to ensure accurate, repeatable measurements and ease of setup. Many of the features require probe characteristics stored in non-volatile memory during calibration that are located in the probe connector.

5.4.1 Probe Serial Number

You can view the serial number of the attached probe from the display of the Model 425. This feature can be used to check the programming of extension cables. To view the serial number, press **Probe Setup**. The probe serial number screen will appear for approximately 3 s. The serial number is up to 10 digits in length.

Menu navigation:

Probe Setup→ (probe serial number screen appears for 3 s)

Interface command: **PRBSNUM?**

5.4.2 Field Compensation

To improve accuracy, all Lake Shore probes have a magnetic field compensation table stored in their EEPROM. Turning field compensation off causes the Model 425 to ignore this table and calculate the field based on a nominal probe sensitivity.



Unless there is a specific reason, Lake Shore strongly advises users not to turn field compensation off; it may reduce reading accuracy substantially.

Menu navigation:

Probe Setup (probe serial number appears for 3 s)→ (off, on)

Default: on

Interface command: **PRBFCOMP**

5.4.3 Extension Cable

Hall effect measurements make it necessary to match extension cables to probes when longer cables are needed. When using an extension cable, the calibration in the probe needs to be copied to the extension cable. Stored information can be viewed on the front panel and read over computer interface to ensure proper mating.



In most cases, you can use uncalibrated extension cables; the probe calibration can be transferred to the extension cable using the Model 425.

Follow this procedure to match a probe with an extension cable.

1. Attach the probe and power on the Model 425.
2. Press and hold **Probe Setup** for approximately 3 s.
3. Select HMPEC program and press **Enter**.
4. With the instrument on, remove the probe, and attach the HMPEC (extension) cable to the Model 425. Press **Enter**.
 - If a valid HMPEC cable is attached, a confirmation message stating “Copying to Cable” will appear while the extension cable is programmed with the probe characteristics. When the copying process is completed, the instrument returns to the normal display.
 - If an invalid HMPEC cable is attached, and the probe matching process is attempted, a message stating “invalid HMPEC cable” appears for 3 s. If this occurs, verify that the HMPEC cable is properly connected. This message will also appear if an attempt is made to copy to a previously calibrated Lake Shore cable.

Menu navigation:

Probe Setup (press and hold for 3 s)→ HMPEC

5.4.4 Clear Zero Probe Calibration

In some instances it may be useful to clear the results of the zero probe function. This could be of value if the probe was zeroed improperly or if there is reason to believe the probe is damaged. By clearing the results of the zero probe function, the instrument clears all probe offset values.

Menu navigation:

Zero Probe (press and hold for 3 s)→ (yes, no)

Interface command: **ZCLEAR**

5.5 Hall Generator

The Model 425 will operate with a discrete Hall generator when a suitable probe is not available. You can program nominal sensitivity and serial number into a blank connector (HMCBL-XX, ordered separately) to provide all gaussmeter functions except field compensation. If the HMCBL cable is not loaded with sensitivity information (or a 0.0 sensitivity is mistakenly entered), the Model 425 reverts to resistance measurement.



Unlike a fully calibrated probe, the accuracy is affected by the Hall sensor non-linearity.

5.5.1 User Programmable Cable

If you connect an HMCBL cable with no sensitivity information (a new blank cable) to the Model 425, a message stating “invalid probe” displays. Press Enter to clear the message. Then program the cable with the serial number and nominal sensitivity of the Hall generator.

If you need to change a previously programmed HMCBL cable, connect the HMCBL cable to the instrument. If an invalid HMCBL cable is attached (for instance, a fully calibrated Lake Shore cable), and the HMCBL program is attempted, a message stating “Invalid MCBL Cable” will appear for approximately 5 s. If this occurs, verify that the cable is properly connected. If the invalid message continues to appear, either replace the cable with a proper HMCBL cable or contact Lake Shore Service.

Enter the nominal sensitivity in mV/kG. This sensitivity is based on a 100 mA Hall current. Use these ranges to set the nominal sensitivity value:

- Between 0.550 mV/kG and 1.100 mV/kG (HST)
- Between 5.500 mV/kG and 11.000 mV/kG (HSE)
- Between 550 mV/kG and 1100 mV/kG (gamma)

The Model 425 will adjust the available ranges based on the values entered for the current and sensitivity.



Using a sensitivity outside the above ranges may cause reduced performance. Values near, but lower than the “55” minimum will reduce resolution. Values near, but above the “11” maximum may cause an instrument overload (OL) condition before full scale range is reached. Therefore, using Hall generators with sensitivities outside the above-indicated ranges is discouraged.

All of the above entries will be stored in the HMCBL cable PROM (located in the connector). Thus, any time you use the cable/Hall generator combination, the Model 425 will recognize the stored parameters, and operation may proceed. You can reprogram the HMCBL cables for other Hall generators as needed.

You can connect a Hall generator directly to the Model 425 without using an HMCBL cable. Probe parameters can be configured as stated above, but the settings will be lost if power is cycled.

Menu navigation:

Probe Setup (press and hold for 3 s) → HMCBL → *serial number entry* → *nominal sensitivity entry*

Interface command: **PRBSENS?** (query only)

5.5.2 Ohms Measurement Mode

The Model 425 can make a 4-lead resistive measurement. If the sensitivity of the probe is set to 0, the instrument will read in ohms. Instrument features are limited in this mode. The following ranges are available in this mode: 3.5 mΩ, 35 mΩ, 350 mΩ, and 3.5 Ω.

Chapter 6: Computer Interface Operation

6.1 General

This chapter provides operational instructions for the computer interface for the Lake Shore Model 425 gaussmeter. The computer interface provided with the Model 425 permits remote operation; its commands are detailed in section 6.3.

6.2 USB Interface

The Model 425 USB interface provides a convenient way to connect to most modern computers, as a USB interface is provided on nearly all new PCs as of the writing of this manual. The USB interface is implemented as a virtual serial communication port connection. This implementation provides a simple migration path for modifying existing RS-232 based remote interface software. It also provides a simpler means of communicating than a standard USB implementation.

6.2.1 Physical Connection

The Model 425 has a B-type USB connector on the rear panel. This is the standard connector used on USB peripheral devices, and it allows a common USB A-type to B-type cable to be used to connect the Model 425 to a host PC. The pin assignments for A-type and B-type connectors are shown in section 8.7. The maximum length of a USB cable, as defined by the USB 2.0 standard, is 5 m (16.4 ft). This length can be extended using USB hubs every 5 m (16.4 ft) up to 5 times, for a maximum total length of 30 m (98.4 ft).

6.2.2 Hardware Support

The USB interface emulates an RS-232 serial port at a fixed baud rate of 57,600, but with the physical connections of a USB. This programming interface requires a certain configuration to communicate properly with the Model 425. The proper configuration parameters are listed in TABLE 6-1.

Baud rate	57,600
Data bits	7
Start bits	1
Stop bits	1
Parity	Odd
Flow control	None
Handshaking	None

TABLE 6-1 *Host communication port configuration*

The Model 425 hardware connection uses the USB 2.0 12,000,000 bits/s signaling rate; however, since the interface uses a virtual serial communication port at a fixed data rate, the data throughput is still limited to a baud rate of 57,600.

6.2.3 Installing the USB Driver

The Model 425 USB driver has been made available through Windows® Update. This is the recommended method for installing the driver, as it will ensure that you always have the latest version of the driver installed. If you are unable to install the driver from Windows® Update, refer to section 6.2.3.3 to install the driver from the Internet or from the CD-ROM provided with the Model 425.

These procedures assume that you are logged into a user account that has administrator privileges.

6.2.3.1 Installing the Driver From Windows® Update in Windows Vista®

1. Connect the USB cable from the Model 425 to the computer.
2. Turn on the Model 425.
3. When the Found New Hardware wizard appears, select **Locate and install driver software (recommended)**.
4. If User Account Control (UAC) is enabled, a UAC dialog box may appear asking if you want to continue. Click **Continue**.
5. The Found New Hardware wizard should automatically connect to Windows® Update and install the drivers.



If the Found New Hardware Wizard is unable to connect to Windows® Update or find the drivers, a message to “Insert the disc that came with your Lake Shore Model 425” will be displayed. Click Cancel and refer to section 6.2.3.3 to install the driver from the Internet.

6. When the Found New Hardware wizard finishes installing the driver, a confirmation message stating “the software for this device has been successfully installed” will appear. Click **Close** to finish installation.

6.2.3.2 Installing the Driver From Windows® Update in Windows® XP

1. Connect the USB cable from the Model 425 to the computer.
2. Turn on the Model 425.
3. When the Found New Hardware wizard appears, select **Yes, this time only** and click **Next**.
4. Select **Install the software automatically (Recommended)** and click **Next**.
5. The Found New Hardware wizard should automatically connect to Windows® Update and install the drivers.



If the Found New Hardware wizard is unable to connect to Windows® Update or find the drivers, a message saying “Cannot install this hardware” will be displayed. Click Cancel and refer to section 6.2.3.3 to install the driver from the Internet.

6. When the Found New Hardware wizard finishes installing the driver a confirmation message stating “the wizard has finished installing the software for Lake Shore Model 425 gaussmeter” will appear. Click **Finish** to complete the installation.

6.2.3.3 Installing the Driver From the Internet

The Model 425 USB driver is available on the Lake Shore website. To install the driver it must be downloaded from the website and extracted. Use the procedure in section 6.2.3.3.1 through section 6.2.3.3.3 to download, extract, and install the driver using Windows Vista® and XP.

6.2.3.3.1 Download the driver

1. Locate the Model 425 USB driver on the downloads page on the Lake Shore website.
2. Right-click on the USB driver download link, and select **save target link as**.
3. Save the driver to a convenient place, and take note as to where the driver was downloaded.

6.2.3.3.2 Extract the driver

The downloaded driver is in a ZIP compressed archive. The driver must be extracted from this file. Windows® provides built-in support for ZIP archives. If this support is disabled, a third-party application, such as WinZip™ or 7-Zip must be used.

For Windows Vista®:

1. Right-click on the file and click **extract all**.
2. An Extract Compressed (Zipped) Folders dialog box will appear. It is recommended the default folder is not changed. Take note of this folder location.
3. Click to clear the **Show extracted files when complete** checkbox, and click **Extract**.

For Windows® XP:

1. Right-click on the file and click **extract all**.
2. The Extraction wizard will appear. Click **Next**.
3. It is recommended the default folder is not changed. Take note of this folder location and click **Next**.
4. An “Extraction complete” message will be displayed. Click to clear the **Show extracted files** checkbox, and click **Finish**.

6.2.3.3.3 Manually install the driver

Manually installing drivers differ between versions of Windows®. The following sections describe how to manually install the driver using Windows Vista® and XP. To install the driver you must be logged into a user account that has administrator privileges.

For Windows Vista®:

1. Connect the USB cable from the Model 425 to the computer.
2. Turn on the Model 425.
3. If the Found New Hardware wizard appears, click **Ask me again later**.
4. Open Device Manager. Use this procedure to open Device Manager.
 - a. Click the Windows® **Start** button and type Device Manager in the **Start Search** box.
 - b. Click on the Device Manager link in the Search Results Under Programs dialog box.
 - c. If User Account Control is enabled click **Continue** on the User Account Control prompt.
5. Click **View** and ensure the **Devices by Type** checkbox is selected.
6. In the main window of Device Manager, locate **Other Devices** in the list of device types. In many instances this will be between Network adapters and Ports (COM & LPT). If the **Other Devices** item is not already expanded, click the + icon. Lake Shore Model 425 should appear indented underneath **Other Devices**. If it is not displayed as Lake Shore Model 425, it might be displayed as USB Device. If neither are displayed, click **Action** and then **Scan for hardware changes**, which may open the Found New Hardware wizard automatically. If the Found New Hardware wizard opens, click **Cancel**.
7. Right-click on Lake Shore Model 425 and click **Update Driver Software**.
8. Click **Browse my computer for driver software**.

9. Click **Browse** and select the location of the extracted driver.
10. Ensure the **Include subfolders** check box is selected and click **Next**.
11. When the driver finishes installing, a confirmation message stating “Windows has successfully updated your driver software” should appear. Click **Close** to complete the installation.

For Windows® XP:

1. Connect the USB cable from the Model 425 to the computer.
2. Turn on the Model 425.
3. The Found New Hardware wizard should appear. If the Found New Hardware wizard does not appear, the following procedure can be used to open the Hardware Update wizard which can be used instead:
 - a. Open Device Manager. Use this procedure to open Device Manager:
 - Right-click on **My Computer** and then click **Properties**. This will open the System Properties dialog.
 - Click the **Hardware** tab, and then click **Device Manager**.
 - b. Click **View** and ensure the **Devices by Type** checkbox is selected.
 - c. In the main window of Device Manager, locate the **Ports (COM & LPT)** device type. In many instances this will be between the Network adapters and Processors items. If the **Ports (COM & LPT)** item is not already expanded, click the + icon. Lake Shore Model 425 should appear indented underneath **Ports (COM & LPT)**. If it is not displayed as Lake Shore Model 425, it might be displayed as USB Device. If neither are displayed, click **Action** and then select **Scan for hardware changes**, which may open the Found New Hardware wizard automatically. If the Found New Hardware wizard opens, continue to step 4.
 - d. Right-click on Lake Shore Model 425 and click **Update Driver**.
4. Select **No, not at this time** and click **Next**.
5. Select **Search for the best driver in these locations**, click to clear the **Search removable media (floppy, CD-ROM)** checkbox, and click the **Include this location in the search** checkbox.
6. Click **Browse** and open the location of the extracted driver.
7. Click **Next**.
8. When the driver finishes installing, a confirmation message stating “The wizard has finished installing the software for Lake Shore Model 425 gaussmeter” should appear. Click **Finish** to complete the installation.

6.2.3.4 Installing the USB Driver from the Included CD-ROM

The Model 425 USB driver is available on the included CD-ROM. The following section describes the process of installing the driver from the CD-ROM. To install the driver you must be logged into a user account that has administrator privileges.

For Windows Vista®:

1. Insert the CD-ROM into the computer.
2. Follow steps 1 to 9 of the Windows Vista® procedure in section 6.2.3.3.3.
3. Click **Browse** and select the drive containing the included CD-ROM.
4. Ensure the **Include subfolders** checkbox is selected and click **Next**.
5. When the driver finishes installing, a confirmation message stating “Windows has successfully updated your driver software” should appear. Click **Close** to complete the installation.

For Windows® XP:

1. Insert the CD-ROM into the computer.
2. Connect the USB cable from the Model 425 to the computer.
3. Turn on the Model 425.

4. When the Found New Hardware wizard appears select **No, not at this time** and click **Next**.
5. Select **Install the software automatically (recommended)** and click **Next**.
6. The Found New Hardware Wizard should automatically search the CD-ROM and install the drivers.
7. When the Found New Hardware wizard finishes installing the drivers, a message stating “the wizard has finished installing the software for Lake Shore Model 425 gaussmeter” should appear. Click **Finish** to complete the installation.

6.2.4 Communication

Communicating via the USB interface is done using message strings. The message strings should be carefully formulated by the user program according to some simple rules to establish effective message flow control.

6.2.4.1 Character Format

A character is the smallest piece of information that can be transmitted by the interface. Each character is ten bits long and contains data bits, bits for character timing, and an error detection bit. The instrument uses seven bits for data in the American Standard Code for Information Interchange (ASCII) format. One start bit and one stop bit are necessary to synchronize consecutive characters. Parity is a method of error detection. One parity bit configured for odd parity is included in each character.

ASCII letter and number characters are used most often as character data. Punctuation characters are used as delimiters to separate different commands or pieces of data. A special ASCII character, line feed (LF OAH), is used to indicate the end of a message string. This is called the message terminator.

6.2.4.2 Message Strings

A message string is a group of characters assembled to perform an interface function. There are three types of message strings—commands, queries and responses. The computer issues command and query strings through user programs; the instrument issues responses. Two or more command or query strings can be chained together in one communication, but they must be separated by a semicolon (;). The total communication string must not exceed 60 characters in length.

A command string is issued by the computer and instructs the instrument to perform a function or change a parameter setting. The format is:

<command mnemonic><space><parameter data><terminators>.

Command mnemonics and parameter data necessary for each command is described in section 6.3. Terminators must be sent with every message string.

A query string is issued by the computer and instructs the instrument to send a response. The query format is:

<query mnemonic><?><space><parameter data><terminators>.

Query mnemonics are often the same as commands with the addition of a question mark. Parameter data is often unnecessary when sending queries. Query mnemonics and parameter data (if necessary) are described in section 6.3. Terminators must be sent with every message string. The computer should expect a response very soon after a query is sent.

A response string is the instrument’s response or answer to a query string. The response can be a reading value, status report or the present value of a parameter. Response data formats are listed along with the associated queries in section 6.3. The response is sent as soon as possible after the instrument receives the query.

6.2.5 Message Flow Control

It is important to remember that the user program is in charge of the USB communication at all times. The instrument cannot initiate communication, determine which device should be transmitting at a given time, or guarantee timing between messages. All of this is the responsibility of the user program.

When issuing commands the user program alone should:

- Properly format and transmit the command including the terminator as one string
- Guarantee that no other communication is started for 30 ms after the last character is transmitted
- Not initiate communication more than 30 times/s

When issuing queries or queries and commands together, the user program should:

- Properly format and transmit the query including the terminator as one string
- Prepare to receive a response immediately
- Receive the entire response from the instrument including the terminator
- Guarantee that no other communication is started during the response or for 30 ms after it completes
- Not initiate communication more than 30 times/s

Failure to follow these rules will result in inability to establish communication with the instrument or intermittent failures in communication.

6.3 Command Summary

This section provides a listing of the interface commands. A summary of all the commands is provided in TABLE 6-2. All the commands are detailed in section 6.3.1, and are presented in alphabetical order.

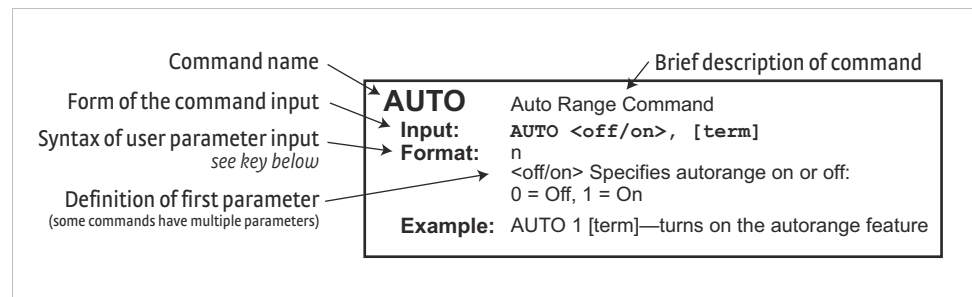

FIGURE 6-1 Sample command format

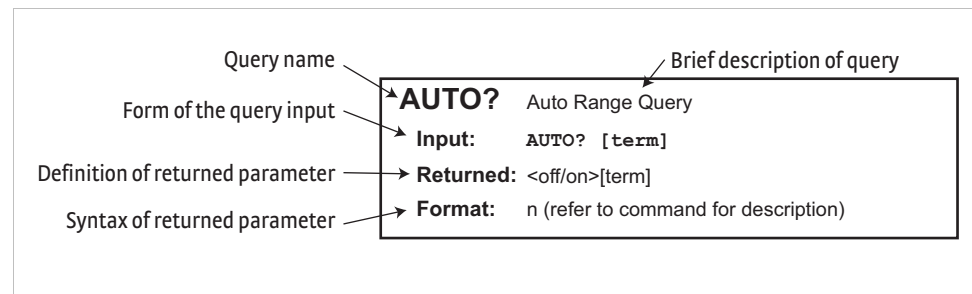

FIGURE 6-2 Sample query format

Command	Function	Page	Command	Function	Page
?	Process Last Query Received	48	PRBSSENS?	Probe Sensitivity Query	51
*IDN?	Identification Query	48	PRBSNUM?	Probe Serial Number Query	51
*RST	Reset Instrument Command	48	RANGE	Field Range Command	51
ALARM	Input Alarm Parameter Command	48	RANGE?	Field Range Query	51
ALARM?	Input Alarm Parameter Query	48	RDGFIELD?	Field Reading Query	51
ALARMST?	Alarm Status Query	48	RDGMODE	Measurement Mode Command	51
AUTO	Auto Range Command	49	RDGMODE?	Measurement Mode Query	52
AUTO?	Auto Range Query	49	RDGMNMX?	Minimum and Maximum Reading Query*	52
BRIGHT	Display Contrast Command	49	RDGMX?	Maximum Reading Query	52
BEEP	Alarm Audible Command*	49	RDGREL?	Relative Reading Query	52
BEEP?	Alarm Audible Query*	49	REL	Relative Mode Command	52
BRIGHT?	Display Contrast Query	49	REL?	Relative Mode Query	52
DFLT	Factory Defaults Command	49	RELAY	Relay Control Parameter Command	52
KEYST?	Keypad Status Query	49	RELAY?	Relay Control Parameter Query	53
LOCK	Front Panel Keypad Lock Command	50	RELAYST?	Relay Status Query	53
LOCK?	Front Panel Keypad Lock Query	50	RELSP	Relative Setpoint Command	53
MXHOLD	Max Hold Command	50	RELSP?	Relative Setpoint Query	53
MXHOLD?	Max Hold Query	50	TYPE?	Probe Type Query	53
MXRST	Max Hold Reset Command	50	UNIT	Field Units Command	53
OPST?	Operational Status Query	50	UNIT?	Field Units Query	53
PRBFCOMP	Probe Field Compensation Command	50	ZCLEAR	Clear Zero Probe Command	54
PRBFCOMP?	Probe Field Compensation Query	51	ZPROBE	Zero Probe Command	54

* These commands were included to support compatibility with the Model 455 and Model 475 gaussmeters

TABLE 6-2 Command summary

6.3.1 Interface Commands

This section lists the interface commands in alphabetical order.

Q	Begins common interface command
?	Required to identify queries
s[n]	String of alphanumeric characters with length “n.” Send these strings using surrounding quotes. Quotes enable characters such as commas and spaces to be used without the instrument interpreting them as delimiters
nn...	String of number characters that may include a decimal point
[term]	Terminator characters
<...>	Indicates a parameter field; many are command specific
<state>	Parameter field with only On/Off or Enable/Disable states
<value>	Floating point values have varying resolution depending on the type of command or query issued

TABLE 6-3 Interface commands key

? Input Returned Remarks	Process Last Query Received ? [term] The response of the last query received by the instrument Reprocesses the last query received by the instrument and sends a new response—this command cannot be chained with other commands and must be sent by itself
QIDN? Input Returned Format	Identification Query QIDN? [term] <manufacturer>,<model>,<instrument serial number>,<firmware version>[term] s[4],s[8],s[7],n.n <manufacturer> Manufacturer ID <model> Instrument model number <serial> Instrument serial number <firmware version> Instrument firmware version
Example	LSCI,MODEL425,4250022,1.0
QRST Input Remarks	Reset Instrument Command QRST [term] Sets controller parameters to power-up settings—use the DFLT command to set defaults
ALARM Input Format	Input Alarm Parameter Command ALARM <off/on>,<mode>,<low value>,<high value>,<out/in>,<alarm sort>,<audible> [term] n,n,±nnn.nnnE±nn,±nnn.nnnE±nn,n,n,n <off/on> Specifies alarm checking on or off: 0 = off, 1 = on <mode> Specifies checking magnitude (absolute value used) or algebraically (includes sign): 1 = magnitude check, 2 = algebraic check <low value> Sets the value the source is checked against to activate low alarm: ±350 kG <high value> Sets the value the source is checked against to activate high alarm: ±350 kG <out/in> Specifies the alarm to trigger on value outside or inside of setpoints: 1 = outside, 2 = inside <alarm sort> Turns alarm sort function on or off: 0 = off, 1 = on <audible> Specifies if the internal speaker will beep when an alarm condition occurs. Valid entries: 0 = off, 1 = on
Example	ALARM 1, 1, 100, 300, 1, 0, 0 [term] —turns alarm checking on—activates alarm if the absolute value of the field is over 300 G, or if the absolute value of the field is below 100 G; sorting is turned off, and instrument will not beep when an alarm condition occurs
ALARM? Input Returned Format	Input Alarm Parameter Query ALARM? [term] <off/on>,<mode>,<low value>,<high value>,<out/in>,<alarm sort>,<audible> [term] n,n,±nnn.nnnE±nn,±nnn.nnnE±nn,n,n,n (refer to command for description)
ALARMST? Input Returned Format	Alarm Status Query ALARMST? [term] <state>[term] n <state> 0 = Non-alarming, 1 = Alarming

AUTO	Auto Range Command
Input	<code>AUTO <off/on>, [term]</code>
Format	n
	<off/on> Specifies autorange on or off: 0 = Off, 1 = On
Example	<code>AUTO 1 [term]</code> —turns on the autorange feature
AUTO?	Auto Range Query
Input	<code>AUTO? [term]</code>
Returned	<off/on>[term]
Format	n (refer to command for description)
BEEP	Alarm Audible Command
Input	<code>BEEP <off/on>, [term]</code>
Format	n
	<off/on> Specifies alarm audible on or off: 0 = Off, 1 = On
Remarks	This command is included to support compatibility with the Model 455 and Model 475 gaussmeters—the alarm audible parameter is now combined with the alarm command
BEEP?	Alarm Audible Query
Input	<code>BEEP? [term]</code>
Returned	<off/on>[term]
Format	n (refer to command for description)
Remarks	This command is included to support compatibility with the Model 455 and Model 475 gaussmeters—the alarm audible parameter is now combined with the alarm command
BRIGT	Display Contrast Command
Input	<code>BRIGT <contrast value> [term]</code>
Format	nn
	<contrast value> 1 to 32
Remarks	Sets the display contrast for the front panel LCD
BRIGT?	Display Contrast Query
Input	<code>BRIGT? [term]</code>
Returned	<contrast value>[term]
Format	nn (refer to command for description)
DFLT	Factory Defaults Command
Input	<code>DFLT 99 [term]</code>
Remarks	Sets all configuration values to factory defaults and resets the instrument—the “99” is included to prevent accidentally setting the unit to defaults
KEYST?	Keypad Status Query
Input	<code>KEYST? [term]</code>
Returned	<keypad status>[term]
Format	nn
Remarks	Returns a number descriptor of the last key pressed since the last KEYST?—KEYST? returns a 00 if no key pressed since last query

LOCK	Front Panel Keypad Lock Command																								
Input	LOCK <state> [term]																								
Format	n <state> 0 = Unlocked, 1 = Locked																								
Remarks	Locks out all front panel entries. Instrument settings can still be viewed but not changed—refer to section 4.6																								
LOCK?	Front Panel Keypad Lock Query																								
Input	LOCK? [term]																								
Returned	<state>,[term]																								
Format	n (refer to command for description)																								
MXHOLD	Max Hold Command																								
Input	MXHOLD <off/on> [term]																								
Format	n <off/on> specifies max hold on or off: 0 = Off, 1 = On																								
Example	MXHOLD 1 [term] —turns the max hold feature on—the Model 425 displays the max value.																								
MXHOLD?	Max Hold Query																								
Input	MXHOLD? [term]																								
Returned	<off/on>[term]																								
Format	n (refer to command for description)																								
MXRST	Max Hold Reset Command																								
Input	MXRST [term]																								
Remarks	Resets the stored maximum field reading and sets it equal to the present field reading																								
OPST?	Operational Status Query																								
Input	OPST? [term]																								
Returned	<bit weighting> [term]																								
Format	nnn																								
Remarks	Returns the sum of the bit weighting of the instrument status bits																								
	<table border="1"> <thead> <tr> <th>Bit</th> <th>Beight weighting</th> <th>Description</th> </tr> </thead> <tbody> <tr> <td>0</td> <td>1</td> <td>No probe: this bit is set if no probe is attached to the instrument</td> </tr> <tr> <td>1</td> <td>2</td> <td>Field overload: this bit is set when the field reading is in an overload condition</td> </tr> <tr> <td>2</td> <td>4</td> <td>New field reading: this bit is set when there is a new field reading</td> </tr> <tr> <td>3</td> <td>8</td> <td>Alarm: this bit is set when there is an alarm condition</td> </tr> <tr> <td>4</td> <td>16</td> <td>Invalid probe: this bit is set when an invalid probe is attached to the instrument</td> </tr> <tr> <td>6</td> <td>64</td> <td>Calibration error: this bit is set if the instrument is not calibrated or the calibration data has been corrupted</td> </tr> <tr> <td>7</td> <td>128</td> <td>Zero probe done: this bit is set when the zero probe function is completed</td> </tr> </tbody> </table>	Bit	Beight weighting	Description	0	1	No probe: this bit is set if no probe is attached to the instrument	1	2	Field overload: this bit is set when the field reading is in an overload condition	2	4	New field reading: this bit is set when there is a new field reading	3	8	Alarm: this bit is set when there is an alarm condition	4	16	Invalid probe: this bit is set when an invalid probe is attached to the instrument	6	64	Calibration error: this bit is set if the instrument is not calibrated or the calibration data has been corrupted	7	128	Zero probe done: this bit is set when the zero probe function is completed
Bit	Beight weighting	Description																							
0	1	No probe: this bit is set if no probe is attached to the instrument																							
1	2	Field overload: this bit is set when the field reading is in an overload condition																							
2	4	New field reading: this bit is set when there is a new field reading																							
3	8	Alarm: this bit is set when there is an alarm condition																							
4	16	Invalid probe: this bit is set when an invalid probe is attached to the instrument																							
6	64	Calibration error: this bit is set if the instrument is not calibrated or the calibration data has been corrupted																							
7	128	Zero probe done: this bit is set when the zero probe function is completed																							
PRBFCOMP	Probe Field Compensation Command																								
Input	PRBFCOMP <off/on> [term]																								
Format	n <off/on> Specifies probe field compensation off or on—valid entries: 0 = Off, 1 = On																								
Example	PRBFCOMP 1 [term] —field measurement uses the probe field compensation table																								

<hr/> PRBFCOMP? Input Returned Format	Probe Field Compensation Query PRBFCOMP? [term] <off/on>[term] n (refer to command for description)
<hr/> PRBSENS? Input Returned Format Remarks	Probe Sensitivity Query PRBSENS? [term] <sensitivity>[term] \pm nnn.nnnE \pm nn Returns the probe sensitivity in mV/kG
<hr/> PRBSNUM? Input Returned Format Remarks	Probe Serial Number Query PRBSNUM? [term] <type>[term] s[8] Returns the probe serial number
<hr/> RANGE Input Format Example	Field Range Command RANGE <range> [term] n <range> Specifies range from lowest to highest: 1 to 4 (field values are probe dependent) RANGE 4 [term] —sets the present range to 4
<hr/> RANGE? Input Format Returned Format	Field Range Query RANGE? [term] n <range>[term] n (refer to command for description)
<hr/> RDGFIELD? Input Returned Format Remarks	Field Reading Query RDGFIELD? [term] <field>[term] \pm nnn.nnnE \pm nn Returns the field reading in a format based on the present units—this is valid for DC or RMS
<hr/> RDGMODE Input Format Example	Measurement Mode Command RDGMODE <mode>, <filter>, <band> [term] n,n,n <mode> Specifies the measurement mode: 1 = DC, 2 = RMS <filter> Turns DC filter on or off: 0 = Off, 1 = On <band> RMS measurement mode: 1 = wide band, 2 = narrow band RDGMODE 2, 1, 1 [term] —the Model 425 is configured for RMS field measurement in wide band mode

RDGMODE?	Measurement Mode Query
Input	RDGMODE? [term]
Returned	<mode>,<filter>,<band>[term]
Format	n,n,n (refer to command for description)
RDGMNMX?	Maximum and Minimum Reading Query
Input	RDGMNMX? [term]
Returned	<min>,<max>[term]
Format	±nnn.nnnE±nn, ±nnn.nnnE±nn
Remarks	This command is included to support compatibility with the Model 455 and Model 475 gaussmeters—in the Model 425, this query will always return zero for the minimum value
RDGMX?	Maximum Reading Query
Input	RDGMX? [term]
Returned	<max>[term]
Format	±nnn.nnnE±nn
Remarks	Returns the most recent maximum field reading
RDGREL?	Relative Reading Query
Input	RDGREL? [term]
Returned	<relative reading>[term]
Format	±nnn.nnnE±nn
Remarks	Returns the relative field reading
REL	Relative Mode Command
Input	REL <off/on> [term]
Format	n
	<off/on> Specifies Relative mode off or on: 0 = Off, 1 = On
Example	REL 1 [term] —relative mode turned on
REL?	Relative Mode Query
Input	REL? [term]
Returned	<off/on>[term]
Format	n (refer to command for description)
RELAY	Relay Control Parameter Command
Input	RELAY <mode>,<alarm type> [term]
Format	n,n
	<mode> Specifies relay mode: 0 = Off, 1 = On, 2 = Alarm
	<alarm type> Specifies the input alarm type that activates the relay when the relay is in alarm mode: 1 = Low alarm, 2 = High Alarm, 3 = Both Alarms
Example	RELAY 2,1 [term] —relay activates when low alarm activates

RELAY?	Relay Control Parameter Query
Input	RELAY? [term]
Returned	<mode>,<alarm type>[term]
Format	n,n (refer to command for description)
<hr/>	
RELAYST?	Relay Status Query
Input	RELAYST? [term]
Returned	<status>[term]
Format	n 0 = Off, 1 = On
<hr/>	
RELSP	Relative Setpoint Command
Input	RELSP <setpoint> [term]
Format	±nnn.nnnE±nn
Example	<setpoint> Specifies the setpoint to use in the relative calculation: ±350 kG RELSP 1200 [term] —configure the relative setpoint as 1200 G (if units in Gauss)—refer to REL command
<hr/>	
RELSP?	Relative Setpoint Query
Input	RELSP? [term]
Returned	<setpoint>[term]
Format	±nnn.nnnE±nn (refer to command for description)
<hr/>	
TYPE?	Probe Type Query
Input	TYPE? [term]
Returned	<type>[term]
Format	nn
Remarks	Returns the probe type: 40 = high sensitivity 41 = high stability 42 = ultra-high sensitivity 50 = user programmable cable/high sensitivity probe 51 = user programmable cable/high stability probe 52 = user programmable cable/ultra-high sensitivity probe
<hr/>	
UNIT	Field Units Command
Input	UNIT <units> [term]
Format	n
Example	<units> 1 = Gauss, 2 = Tesla, 3 = Oersted, 4 = Ampere/meter UNIT 2 [term] —configures the Model 425 to report readings in Tesla
<hr/>	
UNIT?	Field Units Query
Input	UNIT? [term]
Returned	<units>[term]
Format	n (refer to command for description)

ZCLEAR	Clear Zero Probe Command
Input	ZCLEAR [term]
Remarks	Clears the results of the zero probe function

ZPROBE	Zero Probe Command
Input	ZPROBE [term]
Remarks	Initiates the Zero Probe function—place the probe in zero gauss chamber before issuing this command

Chapter 7: Probes and Accessories

7.1 General

This chapter provides information on standard probes and the accessories available for the Model 425 gaussmeter.

7.2 Models

The list of Model 425 model numbers follows:

Model	Description
425	Model 425 gaussmeter
425-HMXX-XXXX-XX	Model 425 gaussmeter with standard probe choice—specify selected probe number for HMXX-XXXX-XX (Please see: http://www.lakeshore.com/products/Hall-Probes/ .)

TABLE 7-1 Model description

Power configurations—the instrument is configured at the factory for customer-selected power as follows:

1	100 V-US (NEMA 5-15)
2	120 V-US (NEMA 5-15)
3	220 V-EU (CEE 7/7)
4	240 V-EU (CEE 7/7)
5	240 V-UK (BS 1363)
6	240 V-Swiss (SEV 1011)
7	220 V-China (GB 1002)

TABLE 7-2 Power configurations

7.3 Accessories

Accessories are devices that perform a secondary duty as an aid or refinement to the primary unit. A list of accessories for the Model 425 is as follows:

Model	Description
G-106-253	I/O mating plug
G-106-264	I/O mating connector shell
4060	Zero gauss chamber
MAN-425*	Model 425 user manual

*RoHS compliant

TABLE 7-3 Accessories included with Model 425

Model	Description of Accessories
4065	Large zero gauss chamber for gamma probe
HMCBL-6	User programmable cable with EEPROM (6 ft)
HMCBL-20	User programmable cable with EEPROM (20 ft)
HMPEC-10-U	Probe extension cable with EEPROM (10 ft), uncalibrated
HMPEC-25-U	Probe extension cable with EEPROM (25 ft), uncalibrated
HMPEC-50-U	Probe extension cable with EEPROM (50 ft), uncalibrated
HMPEC-100-U	Probe extension cable with EEPROM (100 ft), uncalibrated
RM-1/2	Rack mount kit for one 1/2-rack gaussmeter in 483 mm (19 in) rack
RM-2	Rack mount kit for two 1/2-rack gaussmeter in 483 mm (19 in) rack
4030-12	Hall probe stand; 305 mm (12 in) post
4030-24	Hall probe stand; 610 mm (24 in) post

TABLE 7-4 Accessories available

7.4 Rack Mounting

The Model 425 can be installed into a 483 mm (19 in) rack mount cabinet using the optional Lake Shore Model RM-1/2 rack mount kit, or the Model RM-2 dual rack mount shelf. The rack mount kit contains mounting ears, panel, handles, and screws that adapt the front panel to fit into a 88.9 mm (3.5 in) tall full rack space. Refer to FIGURE 7-1 for installation details.



Ensure that there is a 25 mm (1 in) clearance on both sides of the instrument after rack mounting.

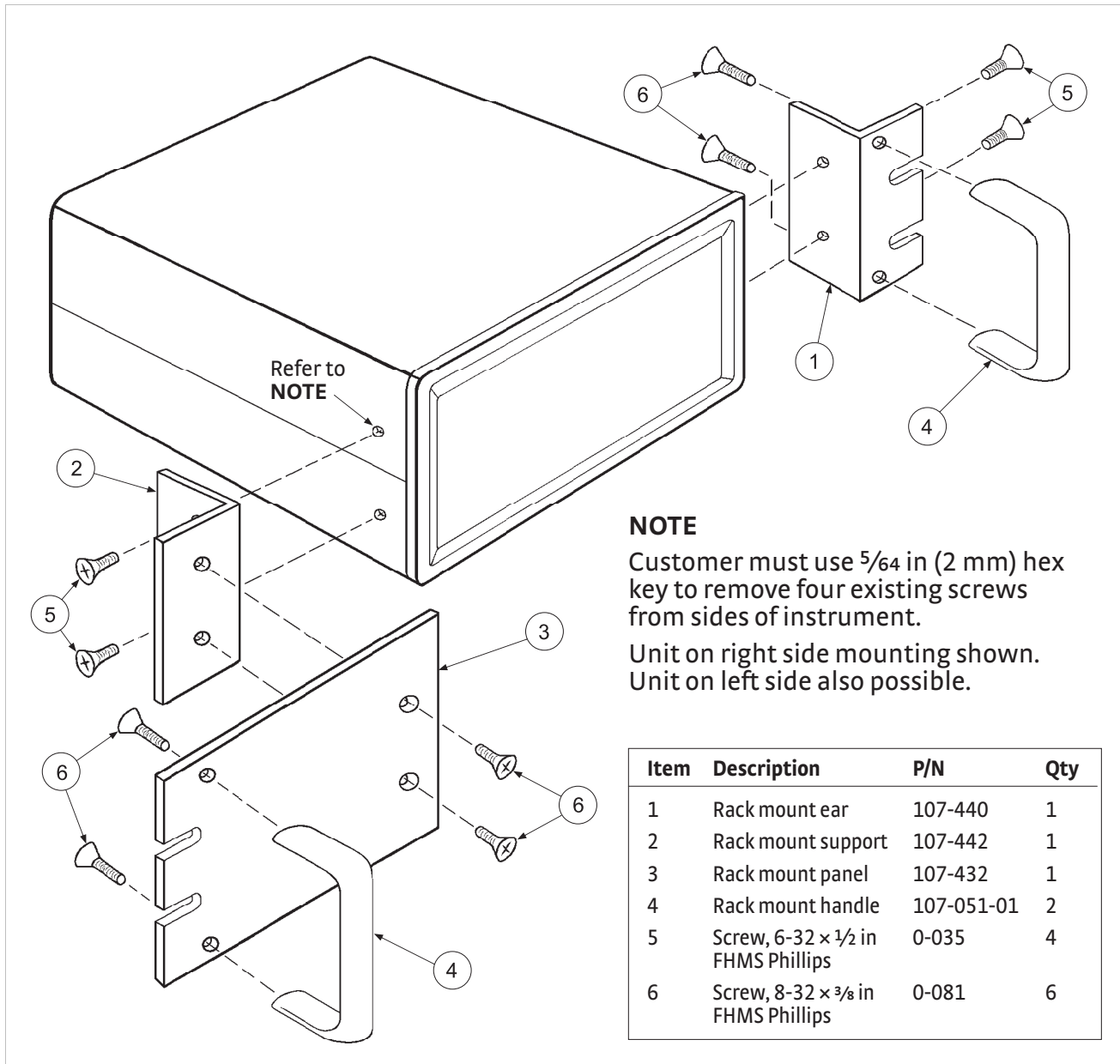

FIGURE 7-1 Model RM-1/2 rack mount kit

7.5 Probe Accessories

Additional accessories are available that may be desirable. A list of accessories available for the 425 gaussmeter is provided in TABLE 7-5. Refer to the Lake Shore Magnetism Catalog for more details.

Part	Part number	Description of accessories
Probe extension cables	HMPEC-10	3 m (10 ft)
	HMPEC-10-U	3 m (10 ft)
	HMPEC-25	8 m (25 ft)
	HMPEC-25-U	8 m (25 ft)
	HMPEC-50	15 m (50 ft)
	HMPEC-50-U	15 m (50 ft)
	HMPEC-100	30 m (100 ft)
	HMPEC-100-U	30 m (100 ft)
Hall generator cable assemblies	HMCBL-6	2 m (6 ft)
	HMCBL-20	6 m (20 ft)
Helmholtz coils	MH-2.5	63.5 mm (2.5 in) inner diameter, field strength: ~30 G at 1 A, maximum continuous current: 2 A, coil resistance: ~3 Ω
	MH-6	152.4 mm (6 in) inner diameter, field strength: ~25 G at 1 A, maximum continuous current: 2 A, coil resistance: ~10 Ω
	MH-12	304.8 mm (12 in) inner diameter, field strength: ~13 G at 1 A, maximum continuous current: 2 A, coil resistance: ~20 Ω
Axial reference magnets	MRA-312-100	7.9 mm (0.312 in) inside diameter, 100 G, 1%
	MRA-312-200	7.9 mm (0.312 in) inside diameter, 200 G, 1%
	MRA-312-300	7.9 mm (0.312 in) inside diameter, 300 G, 1%
	MRA-312-500	7.9 mm (0.312 in) inside diameter, 500 G, 1%
	MRA-312-1K	7.9 mm (0.312 in) inside diameter, 1 kG, 1%
	MRA-312-2K	7.9 mm (0.312 in) inside diameter, 2 kG, 1%
Transverse reference magnets	MRT-062-200	1.6 mm (0.062 in) gap, 200 G, 1%
	MRT-062-500	1.6 mm (0.062 in) gap, 500 G, 1%
	MRT-062-1K	1.6 mm (0.062 in) gap, 1 kG, 0.5%
	MRT-062-2K	1.6 mm (0.062 in) gap, 2 kG, 0.5%
	MRT-062-5K	1.6 mm (0.062 in) gap, 5 kG, 0.5%
	MRT-062-10K	1.6 mm (0.062 in) gap, 10 kG, 0.5%
	MRT-343-50	8.7 mm (0.343 in) gap, 50 G, 1%
	MRT-343-100	8.7 mm (0.343 in) gap, 100 G, 1%
	MRT-343-200	8.7 mm (0.343 in) gap, 200 G, 1%
	MRT-343-1K	8.7 mm (0.343 in) gap, 1 kG, 1%
	MRT-343-2K	8.7 mm (0.343 in) gap, 2 kG, 1%

TABLE 7-5 Probe accessories

7.6 Hall Generator

Lake Shore sells a series of bare Hall generators for applications that are unsuitable for standard probe configurations. Refer to the Hall Generator Application Guide for specifications and other details on the various Hall generators. Specific instructions for installing Hall generators to the Model 425 are in section 3.8. Please consult Lake Shore for availability of bare Hall generator types not detailed in the Magnetism Catalog.

Chapter 8: Service

8.1 General

This chapter provides basic service information for the Model 425 gaussmeter. Customer service of the product is limited to the information presented in this chapter. Lake Shore service personnel should be consulted if the instrument requires repair.



The purpose of this chapter is to help determine if there is a simple solution to your problem, or if something is out of working order. If you verify that there is something wrong with your instrument, do not attempt to open the instrument as there are no serviceable parts inside; contact Lake Shore for service (section 8.10).

8.2 General Troubleshooting

If the Model 425 registers a reading that is not appropriate to the situation, try the following solutions.

- Referto section 8.6 for a list of error messages
- Cycle the power
- Rezero the probe (section 4.5.1.2)
- Reset the instrument to factory defaults (section 8.5)
- To determine whether the issue is with the probe or the instrument, test the instrument with a different probe
- If none of these solutions work, contact Lake Shore (section 8.10)

8.3 USB Troubleshooting

This section provides USB interface troubleshooting for issues that arise with new installations, existing installations, and intermittent lockups.

8.3.1 New Installation

1. Check that the USB driver is installed properly and that the device is functioning. Follow this procedure to check the device status:
 - In Microsoft Windows®, open Device Manager.
 - Locate the **Ports (COM & LPT)** device type. In many instances this will be between the Network adapters and Processors items. If the **Ports (COM & LPT)** item is not already expanded, click the + icon.
 - Lake Shore Model 425 should appear indented underneath **Ports (COM & LPT)** or **Other Devices**. Select Lake Shore Model 425.
 - Click **Properties**. Refer to section 6.2.3 for details on installing the USB driver.
2. Check that the correct communication port is being used. In Microsoft Windows®, the communication port number can be checked in the Device Manager window, under the **Ports (COM & LPT)** device type.
3. Check that the correct settings are being used for communication. Refer to section 6.2.2 for communication port configuration details.
4. Check cable connections and length.
5. Send the message terminator.
6. Send entire message string at one time including the terminator. (Many terminal emulation programs do not.)
7. Send only one simple command at a time until communication is established.
8. Be sure to spell commands correctly and use proper syntax.

8.3.2 Existing Installation No Longer Working

1. Power the instrument off, then on again to see if it is a soft failure.
2. Power the computer off, then on again to see if communication port is locked up.
3. Check all cable connections.
4. Check that the com port assignment has not been changed. In Microsoft Windows®, the com port number can be checked in the Device Manager window, under the **Ports (COM & LPT)** device type.

5. Check that the USB driver is installed properly and that the device is functioning. In Microsoft Windows®, the device status can be checked using the Device Manager. Click **Ports (COM & LPT)** or **Other Devices** in the device type list, and then right-click Lake Shore Model 425 gaussmeter. Click **Properties**.

8.3.3 Intermittent Lockups

1. Check cable connections and length.
2. Increase delay between all commands to 100 ms to make sure instrument is not being overloaded.
3. Ensure that the USB cable is not unplugged and that the Model 425 is not powered down while the com port is open.

! CAUTION

The USB driver creates a com port when the USB connection is detected, and removes the com port when the USB connection is no longer detected. Removal of the com port while in use by software can cause the software to lock up or crash.

8.4 Line Voltage

The Model 425 will operate between the range of 100 VAC to 240 VAC, 50 Hz or 60 Hz configurations so that it can be operated from line power anywhere in the world. No manual switches need to be configured for different voltage operations.

8.5 Factory Reset Menu

It is sometimes necessary to reset instrument parameter values to factory defaults. Instrument parameters are stored in nonvolatile memory called EEPROM, and can be cleared without affecting instrument calibration.

8.5.1 Default Values

The factory defaults can be reset using the factory reset menu. To access the factory reset menu, press and hold **Escape** for 3 s. The firmware version screen will appear; press **Enter** to advance to the instrument serial number information screen, and press **Enter** to go onto the factory reset menu. Once the menu appears, set default values to yes, then press **Enter** to confirm and execute the reset. Press **Escape** at any time to return to the normal display. Default parameter values are listed in TABLE 8-1

	Parameter	Default
Measurement	Measurement mode	DC
	DC filter	On
	RMS measurement band	Narrow
	Autorange	On
	Field compensation	On
	Max hold	Off
	Relative	Off
Display	Brightness	10%
	Field units	Gauss
Alarm and relay	Alarm	Off
	Alarm mode	Magnitude
	Alarm trigger	Outside
	Alarm audible	On
	Alarm sort	On
Keypad locking	Relay	Off
	Mode	Unlocked

TABLE 8-1 Default parameter values

Menu navigation:

Escape (press and hold for 3 s)

Interface command: **DFLT**

8.5.2 Product Information

Product information for your instrument is also found in the Factory Reset menu. The following information is provided:

- Firmware version
- Serial number

8.6 Error Messages

The messages listed in TABLE 8-2 appear on the instrument display when it identifies a problem during operation. The messages are divided into three groups. Instrument hardware messages are related to the instrument’s internal circuits or non-volatile memory. If one of these messages persists after power is cycled, the instrument requires repair or recalibration. Measurement messages are most often associated with over field conditions caused by an improperly selected field range, excessive noise on the measurement leads, or a missing or invalid probe. If these messages persist after proper configuration, the instrument may require repair. Illegal operation messages remind the operator when a feature is locked out or the instrument is not configured to support a feature.

	Message	Description
Instrument hardware error messages	Defective RAM	Internal RAM is defective and must be replaced.
	Invalid EEPROM	EEPROM contents are corrupt, and parameter values will be reset to default. Reoccurrence may indicate defective EEPROM.
	Invalid calibration	Instrument has not been calibrated or calibration memory has been corrupted. Recalibration is required for accurate measurements. Press the Escape and Enter keys simultaneously to clear the message. The instrument can still be used, but it may not be operating within specifications.
Measurement error messages	No probe	There is no probe attached or the attached probe is damaged.
	Invalid probe	The detected probe does not contain calibration information. This is more often the case when using a Hall generator. Press Enter to continue and refer to section 5.5.1 to enter probe sensitivity.
	Incompatible probe	A previous generation probe has been attached. Press Enter to continue. Measurement uses only nominal probe sensitivity. Accuracy not guaranteed.
	OL	The measured field is larger than the range. Increase the measurement range or turn autorange on. Check probe zero. If error condition still exists, the probe may be damaged.
	Probe offset larger than expected	The amount of adjustment required to set the probe to zero is greater than normal for the probe model.
Illegal operation error messages	*LOCKED*	A change was attempted with the keypad locked.
	Invalid HMPEC cable	Improper cable attached during the HMPEC programming process (section 5.5.1).
	Invalid HMCBL cable	Improper cable attached during the HMCBL programming process (section 5.5.1).

TABLE 8-2 Model 425 error messages

8.7 Rear Panel Connector Definitions

The auxiliary I/O, probe input, and USB connectors are shown in FIGURE 8-1 through FIGURE 8-3 and defined in TABLE 8-3 through TABLE 8-5.

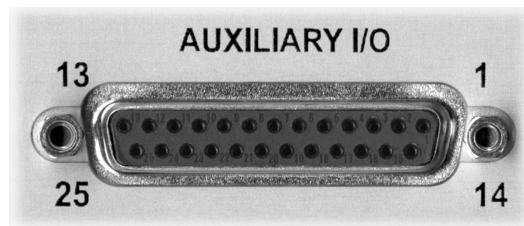

FIGURE 8-1 Auxiliary I/O socket

Pin	Description	Pin	Description
1	Monitor out	14	Ground
2	Internal use only	15	Ground
3	Internal use only	16	Ground
4	No connection	17	No connection
5	Internal use only	18	No connection
6	Internal use only	19	No connection
7	No connection	20	No connection
8	Relay 1 normally open	21	No connection
9	Relay 1 common	22	No connection
10	Relay 1 normally closed	23	No connection
11	Internal use only	24	No connection
12	Internal use only	25	No connection
13	Internal use only		

TABLE 8-3 Auxiliary I/O connector details

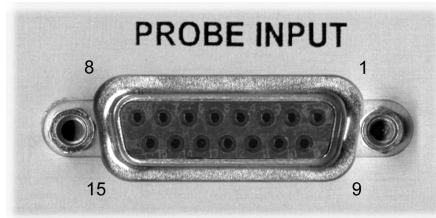

FIGURE 8-2 Probe input socket

Pin	Description	Pin	Description
1	V input +	9	V input –
2	No connection	10	No connection
3	Internal use only	11	EEPROM GND
4	Internal use only	12	EEPROM VCC
5	Internal use only	13	EEPROM CLK
6	Internal use only	14	EEPROM DATA
7	No connection	15	I Hall –
8	I Hall +		

TABLE 8-4 Probe input connector details

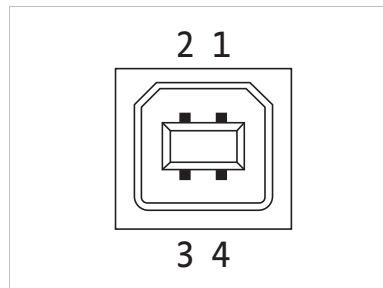

FIGURE 8-3 USB connector

Pin	Name	Description
1	VCC	+5 VDC
2	D-	Data –
3	D+	Data +
4	GND	Ground

TABLE 8-5 USB connector details

8.8 Calibration Procedure

Instrument calibration can be obtained through Lake Shore Service. Refer to section 8.10 for technical inquiries and contact information.

8.9 Firmware Updates

This section provides instructions on updating your firmware. It also provides a table of the updates that have been made thus far.

8.9.1 Updating the Firmware

Periodically, Lake Shore provides updates to instrument firmware. The files for these updates can be downloaded from our website. To access the firmware updates, follow this procedure.

1. Go to <http://www.lakeshore.com/products/gaussmeters/Mode-425-Gaussmeter/pages/overview.aspx> to download the instrument and Ethernet firmware.
2. Enter your name and email address so that we can keep you updated on any new firmware for your instrument.
3. Click the “Go to the download” bar and follow the prompts that are provided on the screen for you.

8.9.2 Record of Updates Made to the Firmware

TABLE 8-6 describes the updates made to the temperature controller in each version.

Instrument firmware version	Features added
1.2	Fixed an issue with the monitor output when switching between AC and DC modes

TABLE 8-6 Instrument firmware updates

8.10 Technical Inquiries

Refer to the following sections when contacting Lake Shore for application assistance or product service. Questions regarding product applications, price, availability and shipments should be directed to sales. Questions regarding instrument calibration or repair should be directed to instrument service. Do not return a product to Lake Shore without a Return Material Authorization (RMA) number (section 8.10.2).

8.10.1 Contacting Lake Shore

The Lake Shore Service Department is staffed Monday through Friday between the hours of 8:00 AM and 5:00 PM EST, excluding holidays and company shut down days.

Contact Lake Shore Service through any of the means listed below. However, the most direct and efficient means of contacting is to complete the online service request form at <http://www.lakeshore.com/sup/serf.html>. Provide a detailed description of the problem and the required contact information. You will receive a response within 24 hours or the next business day in the event of weekends or holidays.

If you wish to contact Service or Sales by mail or telephone, use the following:

Mailing address	Lake Shore Cryotronics Instrument Service Department 575 McCorkle Blvd. Westerville, Ohio USA 43082-8888	
E-mail address	sales@lakeshore.com service@lakeshore.com	Sales Product Service
Telephone	614-891-2244 614-891-2243, option 4	Sales Product Service
Fax	614-818-1600 614-818-1609	Sales Product Service
Web service request	http://www.lakeshore.com/sup/serf.html	Product Service

TABLE 8-7 Contact information

8.10.2 Return of Equipment

The gaussmeter is packaged to protect it during shipment.



The user should retain any shipping carton(s) in which equipment is originally received, in the event that any equipment needs to be returned.

If original packaging is not available, a minimum of 76.2 mm (3 in) of shock absorbent packing material should be placed snugly on all sides of the instrument in a sturdy corrugated cardboard box. Please use reasonable care when removing the gaussmeter from its protective packaging and inspect it carefully for damage. If it shows any sign of damage, please file a claim with the carrier immediately. Do not destroy the shipping container; it will be required by the carrier as evidence to support claims. Call Lake Shore for return and repair instructions.

All equipment returns must be approved by a member of the Lake Shore Service Department. The service engineer will use the information provided in the service request form and will issue an RMA. This number is necessary for all returned equipment. It must be clearly indicated on both the shipping carton(s) and any correspondence relating to the shipment. Once the RMA has been approved, you will receive appropriate documents and instructions for shipping the equipment to Lake Shore.

8.10.3 RMA Valid Period

RMAs are valid for 60 days from issuance; however, we suggest that equipment needing repair be shipped to Lake Shore within 30 days after the RMA has been issued. You will be contacted if we do not receive the equipment within 30 days after the RMA is issued. The RMA will be cancelled if we do not receive the equipment after 60 days.

8.10.4 Shipping Charges

All shipments to Lake Shore are to be made prepaid by the customer. Equipment serviced under warranty will be returned prepaid by Lake Shore. Equipment serviced out-of-warranty will be returned FOB Lake Shore.

8.10.5 Restocking Fee

Lake Shore reserves the right to charge a restocking fee for items returned for exchange or reimbursement.

Appendix A: Units for Magnetic Properties

A.1 Conversion from CGS to SI Units

Quantity	Symbol	Gaussian and CGS emu ^a	Conversion factor, C ^b	SI and rationalized mks ^c
Magnetic flux density, magnetic induction	B	gauss (G) ^d	10 ⁻⁴	tesla (T), Wb/m ²
Magnetic flux	ϕ	maxwell (Mx), G·cm ²	10 ⁻⁸	weber (Wb), volt second (V·s)
Magnetic potential difference, magnetomotive force	U, F	gilbert (Gb)	10/4 π	ampere (A)
Magnetic field strength, magnetizing force	H	oersted (Oe), ^e Gb/cm	10 ³ /4 π	A/m ^f
(Volume) magnetizations ^g	M	emu/cm ^{3h}	10 ³	A/m
(Volume) magnetization	4 π M	G	10 ³ 4 π	A/m
Magnetic polarization, intensity of magnetization	J, I	emu/cm ³	4 π × 10 ⁻⁴	T, Wb/m ²ⁱ
(Mass) magnetization	σ , M	emu/g	$\frac{1}{4\pi} \times 10^{-7}$	A·m ² /kg Wb·m/kg
Magnetic moment	m	emu, erg/G	10 ⁻³	A·m ² , joule per tesla (J/T)
Magnetic dipole moment	j	emu, erg/G	4 π × 10 ⁻¹⁰	Wb·m ²
(Volume) susceptibility	χ_v , κ	dimensionless emu/cm ³	— (4 π) ² × 10 ⁻⁷	Henry per meter (H/m), Wb/A·m
(Mass) susceptibility	χ_p , κ_p	cm ³ /g, emu/g	$\frac{4\pi}{(4\pi)^2} \times 10^{-3}$ $\frac{4\pi}{(4\pi)^2} \times 10^{-10}$	m ³ /kg H·m ² /kg
(Molar) susceptibility	χ_{mol} , κ_{mol}	cm ³ /mol, emu/mol	$\frac{4\pi}{(4\pi)^2} \times 10^{-6}$ $\frac{4\pi}{(4\pi)^2} \times 10^{-13}$	m ³ /mol H·m ² /mol
Permeability	μ	dimensionless	4 π^2 × 10 ⁻⁷	H/m, Wb/A·m
Relative permeability ^j	μ_r	not defined	—	dimensionless
(Volume) energy density, energy product ^k	W	erg/cm ³	10 ⁻¹	J/m ³
Demagnetization factor	D, N	dimensionless	1/4 π	dimensionless

TABLE A-1 Conversion from CGS to SI units

