

---

## User's Manual

# Model 211 Temperature Monitor

Serial Numbers 21A0000 and Subsequent



Lake Shore Cryotronics, Inc.  
575 McCorkle Boulevard  
Westerville, Ohio 43082-8888 USA

E-Mail Addresses:  
sales@lakeshore.com  
service@lakeshore.com

Visit Our Website:  
[www.lakeshore.com](http://www.lakeshore.com)

Fax: (614) 891-1392  
Telephone: (614) 891-2243

Methods and apparatus disclosed and described herein have been developed solely on company funds of Lake Shore Cryotronics, Inc. No government or other contractual support or relationship whatsoever has existed which in any way affects or mitigates proprietary rights of Lake Shore Cryotronics, Inc. in these developments. Methods and apparatus disclosed herein may be subject to U.S. Patents existing or applied for. Lake Shore Cryotronics, Inc. reserves the right to add, improve, modify, or withdraw functions, design modifications, or products at any time without notice. Lake Shore shall not be liable for errors contained herein or for incidental or consequential damages in connection with furnishing, performance, or use of this material.

### LIMITED WARRANTY STATEMENT – WARRANTY PERIOD: THREE (3) YEAR

1. Lake Shore warrants that products manufactured by Lake Shore (the "Product") will be free from defects in materials and workmanship for three years from the date of Purchaser's physical receipt of the Product (the "Warranty Period"). If Lake Shore receives notice of any such defects during the Warranty Period and the defective Product is shipped freight prepaid back to Lake Shore, Lake Shore will, at its option, either repair or replace the Product (if it is so defective) without charge for parts, service labor or associated customary return shipping cost to the Purchaser. Replacement for the Product may be by either new or equivalent in performance to new. Replacement or repaired parts, or a replaced Product, will be warranted for only the unexpired portion of the original warranty or 90 days (whichever is greater).
  2. Lake Shore warrants the Product only if the Product has been sold by an authorized Lake Shore employee, sales representative, dealer or an authorized Lake Shore original equipment manufacturer (OEM).
  3. The Product may contain remanufactured parts equivalent to new in performance or may have been subject to incidental use when it is originally sold to the Purchaser.
  4. The Warranty Period begins on the date of Purchaser's physical receipt of the Product or later on the date of operational training and verification (OT&V) of the Product if the service is performed by Lake Shore, provided that if the Purchaser schedules or delays the Lake Shore OT&V for more than 30 days after delivery then the Warranty Period begins on the 31st day after Purchaser's physical receipt of the Product.
  5. This limited warranty does not apply to defects in the Product resulting from (a) improper or inadequate installation (unless OT&V services are performed by Lake Shore), maintenance, repair or calibration, (b) fuses, software, power surges, lightning and non-rechargeable batteries, (c) software, interfacing, parts or other supplies not furnished by Lake Shore, (d) unauthorized modification or misuse, (e) operation outside of the published specifications, (f) improper site preparation or site maintenance (g) natural disasters such as flood, fire, wind, or earthquake, or (h) damage during shipment other than original shipment to you if shipped through a Lake Shore carrier.
  6. This limited warranty does not cover: (a) regularly scheduled or ordinary and expected recalibrations of the Product; (b) accessories to the Product (such as probe tips and cables, holders, wire, grease, varnish, feedthroughs, etc.); (c) consumables used in conjunction with the Product (such as probe tips and cables, probe holders, sample tails, rods and holders, ceramic putty for mounting samples, Hall sample cards, Hall sample enclosures, etc.); or, (d) non-Lake Shore branded Products that are integrated with the Product.
  7. To the extent allowed by applicable law, this limited warranty is the only warranty applicable to the Product and replaces all other warranties or conditions, express or implied, including, but not limited to, the implied warranties or conditions of merchantability and fitness for a particular purpose. Specifically, except as provided herein, Lake Shore undertakes no responsibility that the products will be fit for any particular purpose for which you may be buying the Products. Any implied warranty is limited in duration to the warranty period. No oral or written information, or advice given by the Company, its Agents or Employees, shall create a warranty or in any way increase the scope of this limited warranty. Some countries, states or provinces do not allow limitations on an implied warranty, so the above limitation or exclusion might not apply to you. This warranty gives you specific legal rights and you might also have other rights that vary from country to country, state to state or province to province.
  8. Further, with regard to the United Nations Convention for International Sale of Goods (CISC.) if CISG is found to apply in relation to this agreement, which is specifically disclaimed by Lake Shore, then this limited warranty excludes warranties that: (a) the Product is fit for the purpose for which goods of the same description would ordinarily be used, (b) the Product is fit for any particular purpose expressly or impliedly made known to Lake Shore at the time of the conclusion of the contract. (c) the Product is contained or packaged in a manner usual for such goods or in a manner adequate to preserve and protect such goods where it is shipped by someone other than a carrier hired by Lake Shore.
  9. Lake Shore disclaims any warranties of technological value or of non-infringement with respect to the Product and Lake Shore shall have no duty to defend, indemnify, or hold harmless you from and against any or all damages or costs incurred by you arising from the infringement of patents or trademarks or violation or copyrights by the Product.
  10. THIS WARRANTY IS NOT TRANSFERRABLE. This warranty is not transferrable.
-



11. Except to the extent prohibited by applicable law, neither Lake Shore nor any of its subsidiaries, affiliates or suppliers will be held liable for direct, special, incidental, consequential or other damages (including lost profit, lost data, or downtime costs) arising out of the use, inability to use or result of use of the product, whether based in warranty, contract, tort or other legal theory, regardless whether or not Lake Shore has been advised of the possibility of such damages. Purchaser's use of the Product is entirely at Purchaser's risk. Some countries, states and provinces do not allow the exclusion of liability for incidental or consequential damages, so the above limitation may not apply to you.
12. This limited warranty gives you specific legal rights, and you may also have other rights that vary within or between jurisdictions where the product is purchased and/or used. Some jurisdictions do not allow limitation in certain warranties, and so the above limitations or exclusions of some warranties stated above may not apply to you.

Except to the extent allowed by applicable law, the terms of this limited warranty statement do not exclude, restrict or modify the mandatory statutory rights applicable to the sale of the product to you.

### **CERTIFICATION**

Lake Shore certifies that this product has been inspected and tested in accordance with its published specifications and that this product met its published specifications at the time of shipment. The accuracy and calibration of this product at the time of shipment are traceable to the United States National Institute of Standards and Technology (NIST); formerly known as the National Bureau of Standards (NBS), or to a recognized natural standard.

### **TRADEMARK ACKNOWLEDGEMENT**

Manufacturers and sellers claim many designations as trademarks to distinguish their products. Where those designations appear in this manual and Lake Shore was aware of a trademark claim, the designations appear in initial capital letters with a <sup>TM</sup> or <sup>®</sup> symbol.

CalCurve<sup>TM</sup>, Cernox<sup>®</sup>, Duo-Twist<sup>TM</sup>, Quad-Lead<sup>TM</sup>, Quad-Twist<sup>TM</sup>, Rox<sup>TM</sup>, and SoftCal<sup>TM</sup> are trademarks of Lake Shore Cryotronics, Inc.

Copyright © 2002 - 2017 by Lake Shore Cryotronics, Inc. All rights reserved. No portion of this manual may be reproduced, stored in a retrieval system, or transmitted, in any form or by any means, electronic, mechanical, photocopying, recording, or otherwise, without the express written permission of Lake Shore.

---

### **ELECTROMAGNETIC COMPATIBILITY ADDENDUM**

Electromagnetic Compatibility (EMC) of electronic equipment is a growing concern worldwide. Emissions of and immunity to electromagnetic interference is now part of most electronics design and manufacture. To qualify for the CE mark, the Model 211 meets the generic requirements of the European EMC Directive 89/336/EEC as a Class B product.

The instrument was tested under normal operating conditions with sensor and interface cables attached. If the installation and operating instructions in the User's Manual are followed there should be no degradation in EMC performance.

Pay special attention to instrument cabling. Improperly installed cabling may defeat even the best EMC protection. For the best performance from any precision instrument, follow the grounding and shielding instructions in the User's Manual. In addition, the installer of the Model 211 should consider the following:

- Leave no unused or unterminated cables attached to the instrument.
- Make cable runs as short and direct as possible.
- Do not tightly bundle cables that carry different types of signals.

### **FIRMWARE LIMITATIONS**

Lake Shore has worked to ensure that the Model 211 firmware is as free of errors as possible, and that the results you obtain from the instrument are accurate and reliable. However, as with any computer-based software, the possibility of errors exists.

In any important research, as when using any laboratory equipment, results should be carefully examined and rechecked before final conclusions are drawn. Neither Lake Shore nor anyone else involved in the creation or production of this firmware can pay for loss of time, inconvenience, loss of use of the product, or property damage caused by this product or its failure to work, or any other incidental or consequential damages. Use of our product implies that you understand the Lake Shore license agreement and statement of limited warranty.

### **FIRMWARE LICENSE AGREEMENT**

The firmware in this instrument is protected by United States copyright law and international treaty provisions. To maintain the warranty, the code contained in the firmware must not be modified. Any changes made to the code is at the user's risk. Lake Shore assumes no responsibility for damage or errors incurred as result of any changes made to the firmware.

Under the terms of this agreement you may only use the Model 211 firmware as physically installed in the instrument. Archival copies are strictly forbidden. You may not decompile, disassemble, or reverse engineer the firmware. If you suspect there are problems with the firmware, return the instrument to Lake Shore for repair under the terms of the Limited Warranty specified above. Any unauthorized duplication or use of the Model 211 firmware in whole or in part, in print, or in any other storage and retrieval system is forbidden.

---



## TABLE OF CONTENTS

<i>Chapter/Paragraph</i>	<i>Title</i>	<i>Page</i>
<b>1</b>	<b>INTRODUCTION .....</b>	<b>1-1</b>
1.0	GENERAL .....	1-1
1.1	DESCRIPTION .....	1-1
1.2	SPECIFICATIONS .....	1-3
1.3	SAFETY SUMMARY .....	1-8
1.4	SAFETY SYMBOLS .....	1-9
<b>2</b>	<b>INSTALLATION .....</b>	<b>2-1</b>
2.0	GENERAL .....	2-1
2.1	INSPECTION AND UNPACKING .....	2-1
2.2	REAR PANEL DEFINITION .....	2-2
2.3	POWER INPUT CONNECTOR .....	2-2
2.4	EXTERNAL POWER SUPPLY .....	2-3
2.5	CABLE CLAMP .....	2-3
2.6	SENSOR INPUT .....	2-3
2.6.1	Input/Output Connector .....	2-4
2.6.2	Sensor Lead Cable .....	2-4
2.6.3	Shielding Sensor Leads .....	2-5
2.6.4	Instrument Grounding .....	2-5
2.6.5	Sensor Polarity .....	2-6
2.6.6	4-Lead Sensor Measurement .....	2-6
2.6.7	2-Lead Sensor Measurement .....	2-7
2.6.8	Lowering Measurement Noise .....	2-7
2.7	ANALOG OUTPUT .....	2-8
2.8	RELAYS .....	2-8
2.9	PANEL MOUNTING .....	2-9
<b>3</b>	<b>OPERATION .....</b>	<b>3-1</b>
3.0	GENERAL .....	3-1
3.1	INSTRUMENT POWER .....	3-1
3.2	DISPLAY DEFINITION .....	3-1
3.3	LED ANNUNCIATORS and DISPLAY MESSAGES .....	3-2
3.4	KEYPAD DEFINITION .....	3-3
3.4.1	Key Descriptions .....	3-3
3.4.2	General Keypad Operation .....	3-3
3.5	INPUT SETUP .....	3-4
3.5.1	Input Type .....	3-4
3.5.2	Curve Selection .....	3-5
3.5.3	Display Units Selection .....	3-6
3.6	ALARM SETUP and OPERATION .....	3-6
3.7	RELAY SETUP .....	3-7

## TABLE OF CONTENTS (continued)

<i>Chapter/Paragraph</i>	<i>Title</i>	<i>Page</i>
3.8	ANALOG OUTPUT SETUP .....	3-8
3.9	ANALOG OUTPUT TO TEMPERATURE CONVERSION .....	3-9
3.10	LOCKING AND UNLOCKING THE KEYPAD .....	3-10
3.11	RESETTING THE MODEL 211 TO DEFAULT VALUES.....	3-10
3.12	CHECKING CODE DATE REVISION.....	3-10
3.13	CURVE ENTRY AND STORAGE .....	3-11
3.13.1	Curve Header Parameters .....	3-11
3.13.2	Curve Breakpoints .....	3-12
<b>4</b>	<b>REMOTE OPERATION .....</b>	<b>4-1</b>
4.0	GENERAL .....	4-1
4.1	SERIAL INTERFACE OVERVIEW .....	4-1
4.1.1	Physical Connection .....	4-1
4.1.2	Hardware Support.....	4-2
4.1.3	Character Format .....	4-3
4.1.4	Message Strings .....	4-3
4.1.5	Message Flow Control.....	4-4
4.1.6	Serial Interface Basic Program .....	4-5
4.1.6.1	Visual Basic Serial Interface Program Setup.....	4-5
4.1.6.2	Program Operation.....	4-10
4.1.7	Trouble Shooting .....	4-10
4.2	SERIAL INTERFACE COMMAND SUMMARY.....	4-11
4.2.1	Interface Commands (In Alphabetical Order) .....	4-14
<b>5</b>	<b>SERVICE .....</b>	<b>5-1</b>
5.0	GENERAL .....	5-1
5.1	CONTACTING LAKE SHORE.....	5-1
5.2	RETURNING PRODUCTS TO LAKE SHORE .....	5-2
5.3	ERROR MESSAGES .....	5-2
5.3.1	Instrument Hardware Errors .....	5-2
5.3.2	Limit Errors .....	5-3
5.4	OPENING THE ENCLOSURE .....	5-3
5.5	CONNECTOR DEFINITIONS .....	5-4
5.5.1	Serial Interface Cable Wiring .....	5-6
5.6	CALIBRATION PROCEDURE .....	5-7
5.6.1	Equipment Required for Calibration.....	5-7
5.6.2	Diode/Resistor Sensor Input Calibration .....	5-7
5.6.2.1	Sensor Input Calibration Setup and Serial Communication Verification.....	5-7



## TABLE OF CONTENTS (continued)

<i>Chapter/Paragraph</i>	<i>Title</i>	<i>Page</i>
5.6.2.2	10 $\mu$ A Current Source Calibration and 1 mA Current Source Verification .....	5-8
5.6.2.3	Input Gain Calibration .....	5-8
5.6.3	Analog Output Calibration and Verification .....	5-10
5.6.3.1	Analog Output Voltage Mode Calibration .....	5-10
5.6.3.2	Analog Output Current Mode Calibration .....	5-11
5.6.4	Calibration Specific Interface Commands .....	5-13
<b>6</b>	<b>OPTIONS AND ACCESSORIES .....</b>	<b>6-1</b>
6.0	GENERAL .....	6-1
6.1	MODELS .....	6-1
6.2	ACCESSORIES .....	6-1
6.3	WIRES .....	6-2
6.4	SENSORS .....	6-2
<b>Appendix A</b>	<b>CURVE TABLES .....</b>	<b>A-1</b>
A1.0	GENERAL .....	A-1
<b>Appendix B</b>	<b>REGULATORY DECLARATIONS .....</b>	<b>A-5</b>
B1.0	General .....	A-5
B1.1	Model 211 CE Declaration of Conformity .....	A-6
B1.2	Power Supply CE Declaration, P/N 109-132 .....	A-7
B1.3	CE Declarations for Discontinued Power Supplies .....	A-8
B1.4	RoHS Declarations for Discontinued Power Supplies .....	A-11
<b>Appendix C</b>	<b>MENU STRUCTURE .....</b>	<b>A-14</b>

## LIST OF ILLUSTRATIONS

<i>Figure No.</i>	<i>Title</i>	<i>Page</i>
Figure 1-1.	Model 211 Front Panel .....	1-1
Figure 2-1.	Model 211 Rear Panel .....	2-2
Figure 2-2.	Power Connector .....	2-3
Figure 2-3.	Input/Output Connector.....	2-4
Figure 2-4.	Panel Mounting Details .....	2-9
Figure 2-5.	2111 and 2112 Panel Mount Adapters .....	2-10
Figure 3-1.	Model 211 Display .....	3-2
Figure 5-1.	Power Connector .....	5-4
Figure 5-2.	Input/Output Connector.....	5-4
Figure 5-3.	RS-232 (DTE) Connector.....	5-5

## LIST OF TABLES

<i>Table No.</i>	<i>Title</i>	<i>Page</i>
Table 1-1.	Temperature Range of Typical Lake Shore Sensors .....	1-2
Table 1-2.	Sensor Input Performance Chart.....	1-6
Table 3-1.	Sensor Input Types .....	3-4
Table 3-2.	Standard Curves.....	3-5
Table 3-3.	Analog Output Range Scales .....	3-9
Table 3-4.	Analog Output Scales in Sensor Units.....	3-9
Table 3-5.	Conversion Parameters for Temperature in K .....	3-9
Table 3-6.	Model 211 Default Values.....	3-10
Table 3-7.	Recommended Curve Parameters.....	3-12
Table 4-1.	Serial Interface Specifications .....	4-3
Table 4-2.	Serial Interface Program Control Properties.....	4-6
Table 4-3.	Visual Basic Serial Interface Program.....	4-8
Table 4-4.	Interface Commands (Alphabetical Listing).....	4-13
Table 5-1.	Calibration Table for Resistive Ranges .....	5-9
Table A-1.	Lake Shore DT-470 Silicon Diode (Curve 10) .....	A-1
Table A-2.	Lake Shore DT-670 Silicon Diode .....	A-2
Table A-3.	CTI Curve C Silicon Diode .....	A-3
Table A-4.	Lake Shore PT-100/-1000 Platinum RTD Curves .....	A-4

# CHAPTER 1

## INTRODUCTION

### 1.0 GENERAL

This chapter provides an introduction to the Model 211 Temperature Monitor. The Model 211 was designed and manufactured in the United States of America by Lake Shore Cryotronics, Inc. A general description is provided in Paragraph 1.1, specifications in Paragraph 1.2, safety summary in Paragraph 1.3, and safety symbols in Paragraph 1.4.

### 1.1 DESCRIPTION

The Lake Shore single-channel Model 211 Temperature Monitor provides the accuracy, resolution, and interface features of a benchtop temperature monitor in an easy to use, easily integrated, compact instrument. With appropriate sensors, the Model 211 measures temperature from 1.4 to 800 K and in difficult sensing conditions, including high vacuum and magnetic fields. Alarms, relays, user-configurable analog voltage or current output, and a serial interface are standard features on the Model 211. Backed by the Lake Shore tradition of excellence in cryogenic and precision temperature measurement for science and industry, the Model 211 is a good choice for liquefied gas storage/monitoring, cryopump control, cryo-cooler, and materials science applications, and for applications that require greater accuracy than thermocouples allow.

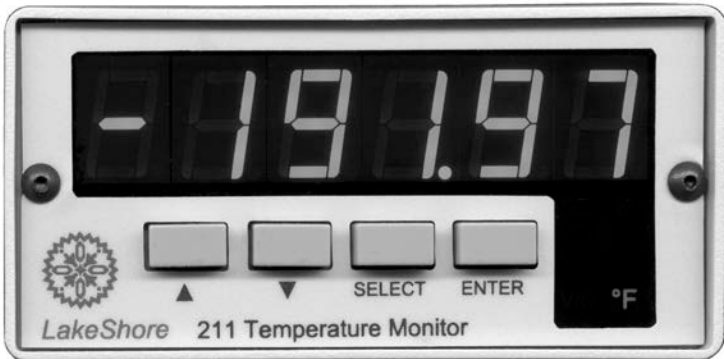

211\_LED\_Front.bmp

**Figure 1-1. Model 211 Front Panel**

*Description (Continued)*

The Model 211 Temperature Monitor supports diode temperature sensors and resistance temperature detectors (RTDs). The Model 211 can be configured for the type of sensor in use from the instrument front panel. Four-lead differential measurement and 24-bit analog-to-digital conversion ensure high accuracy and 5-digit measurement resolution. Temperature data can be read up to seven times per second over computer interface; the display is updated twice each second.

The Model 211 converts voltage or resistance to temperature units based on temperature response curve data for the sensor in use. Standard temperature response curves for silicon diodes and platinum RTDs are included in instrument firmware. The Model 211 also provides non-volatile memory for one 200-point temperature response curve, which can be entered via the serial interface. Measurements are available in temperature units K, °C, °F, or sensor units V or  $\Omega$ .

With an RS-232C serial interface and other interface features, the Model 211 is valuable as a stand-alone monitor and is easily integrated into other systems. Setup and every instrument function can be performed via serial interface or the front panel of the Model 211. High and low alarms can be used in latching mode for error limit detection and in non-latching mode in conjunction with relays to perform simple on-off control functions. The analog output can be configured for either 0 to 10 V or 4 to 20 mA output.

**Table 1-1. Temperature Range of Typical Lake Shore Sensors\***

<i>Diodes</i>	<i>Model</i>	<i>Useful Range</i>
Silicon Diodes	DT-670	1.4 – 500 K
GaAlAs Diode	TG-120	1.4 – 475 K
<i>Positive Temperature Coefficient (PTC) RTDs</i>		
100 $\Omega$ Platinum RTD	PT-100, 250 $\Omega$ full scale	30 – 675 K
100 $\Omega$ Platinum RTD	PT-100, 500 $\Omega$ full scale	30 – 800 K
Rhodium-Iron RTD	RF-800-4	1.4 – 400 K
<i>Negative Temperature Coefficient (NTC)<sup>†</sup> RTDs</i>		
Germanium RTD	GR-200A-1000	2 – 100 K
Germanium RTD	GR-200A-250	1.2 – 40 K
Carbon-Glass RTD	CGR-1-500	3 – 325 K
Cernox™ RTD	CX-1050 AA or SD	3.5 – 325 K
Cernox™ RTD	CX-1030 AA or SD	2 – 325 K
High-Temperature Cernox™ RTD	CX-1030-SD-HT	2 – 420 K
Rox™ Ruthenium Oxide RTD	RX-102A	2 – 40 K
Rox™ Ruthenium Oxide RTD	RX-202A	3 – 40 K

\* Sensors sold separately.

<sup>†</sup> Single excitation current may limit the low temperature range of NTC resistors.

## 1.2 SPECIFICATIONS

### Thermometry

Number of Inputs: 1

Measurement Type: 4-lead differential

Excitation: Constant current, 10  $\mu$ A or 1 mA

Isolation: Measurement is not isolated from chassis ground

A/D Resolution: 24-bit

Input Accuracy: Sensor dependent; refer to Table 1-2

Measurement Resolution: Sensor dependent; refer to Table 1-2

Maximum Update Rate: 7 rdg/s

Supported Sensors: Diodes: Silicon, GaAlAs;

RTDs: 100  $\Omega$  Platinum, 1000  $\Omega$  Platinum, Cernox™, Carbon-Glass, Rox™

Standard Curves: DT-470, DT-670, CTI Curve C, PT-100, PT-1000

User Curve: One 200-point CalCurve™ or user curve in non-volatile memory

Settings: Sensor Type, Sensor Curve

Input Connector: DB-25

### Front Panel

Display Type: 5-digit LED

Display Units: K, °C, °F, V,  $\Omega$

Display Update Rate: 2 rdg/s

Temperature Display Resolution: 0.001° between 0–99.999°,  
0.01° between 100–999.99°, 0.1° above 1000°

Sensor Units Display Resolution: Sensor dependent to 5 digits

Display Annunciators: K, °C, °F, V/ $\Omega$

Keys: Select, Enter, s (Up Arrow), t (Down Arrow)

Front Panel Features: Display Units, Display Brightness,  
Keypad Lockout, Instrument Reset

### Interface

Serial Interface:

Format: RS-232C

Baud Rate: 9600 baud

Reading Rate: To 7 rdg/s

Special Features: User Curve Entry, LabView™ Driver

Connector: DE-9

Alarms:

Number: 2, High and Low

Settings: High Setpoint, Low Setpoint, Dead band,  
Latching or Non-Latching, Alarm On/Off

Actuators: Display message, relays

**Interface (Continued)**

Relays:

Number: 2

Contacts: Normally Open (NO), Normally Closed (NC), and Common (C)

Contact Rating: 30 VDC at 1 A

Settings: manually off, manually on, follows alarms

Connector: DB-25 (shares input connector)

Analog Output:

Isolation: Output is not isolated from chassis ground

Update Rate: 7 rdg/s

	Voltage	Current
Range:	0–10 V	4–20 mA
Resolution:	0.15 mV	0.3 $\mu$ A
Accuracy:	$\pm 1.25$ mV	$\pm 5.0$ $\mu$ A
Minimum Load Resistance:	500 $\Omega$ (short-circuit protected)	NA
Compliance Voltage:	NA	10 V
Load Regulation	NA	$\pm 0.02\%$ rdg 0 to 500 $\Omega$

Scales:

Temperature	Sensor Units (Fixed by type)
0–20 K	Diodes: 1 V = 1V
0–100 K	100 $\Omega$ Platinum: 1 V = 100 $\Omega$
0–200 K	1000 $\Omega$ Platinum: 1 V = 1000 $\Omega$
0–325 K	NTC Resistor: 1 V = 1000 $\Omega$
0–475 K	
0–1000 K	

Settings: Voltage or current, scale

Connector: DB-25 (shares input connector)

**General**

**Ambient Temperature Range:** 15–35  $^{\circ}$ C (59–95  $^{\circ}$ F) at rated accuracy,  
10–40  $^{\circ}$ C (50–104  $^{\circ}$ F) at reduced accuracy

**Power Requirement:** Regulated +5 VDC at 400 mA, Barrel Plug 5.5mm OD x  
2.1mm ID x 9.9mm L 

**Size:** 96 mm W  $\times$  48 mm H  $\times$  166 mm D (3.8  $\times$  1.9  $\times$  6.5 in)

**Mounting:** Panel mount into 91 mm W  $\times$  44 mm H (3.6  $\times$  1.7 in) cutout

**Weight:** 0.45 kg (1 lb)

**Approval:** CE mark, RoHS compliant

### **Power Supply (109-132)**

**Power requirements:** 100-240 VAC, 50 or 60 Hz, 0.3 A max

**Output:** +5 V at 1.2 A

**Size:** 40.5 mm W × 30.0 mm H × 64 mm D (1.6 in × 1.2 in × 2.5 in)

**Weight:** 0.15 kg (0.33 lb)

### **Ordering Information**

#### ***Part Number      Description***

211S                      Model 211 temperature monitor, single channel

211N                      Model 211 with no power supply

#### ***Accessories included with the Model 211 Temperature Monitor***

109-132                  100-240 V, 6 W power supply (universal input, interchangeable input plugs)

G-106-253                Sensor input mating connector (DB-25)

G-106-264                Shell for sensor input mating connector

G-110-110                Rubber feet

0-204                      Cable clamp

—                            Calibration certificate

MAN-211                  User's manual

#### ***Options and Accessories***

2111                      Single ¼-DIN panel mount adapter (see Figure 2-5)

2112                      Dual ¼-DIN panel mount adapter (see Figure 2-5)

8000                      CalCurve™, CD-ROM (included with calibrated sensor)

8001-211                 CalCurve™, factory installed

CAL-211-CERT            Instrument recalibration with certificate

CAL-211 DATA          Instrument recalibration with certificate and data

**Table 1-2. Sensor Input Performance Chart**

Sensor Type	Silicon Diode DT-670	GaAlAs Diode
<b>Temperature Coefficient</b>	Negative	Negative
<b>Sensor Units</b>	volts (V)	volts (V)
<b>Input Range</b>	0 – 2.5 V	0 – 7.5 V
<b>Sensor Excitation</b> (Constant Current)	10 $\mu$ A $\pm$ 0.05%	10 $\mu$ A $\pm$ 0.05%
<b>Display Resolution</b> (Sensor Units)	100 $\mu$ V	100 $\mu$ V
<b>Example Lake Shore Sensor</b>	DT-670-SD with 1.4H calibration	TG-120SD with 1.4H calibration
<b>Temperature Range</b>	1.4 – 475 K	1.4 – 475 K
<b>Standard Sensor Curve</b>	DT-670	Requires calibration
<b>Typical Sensor Sensitivity</b>	-31.6 mV/K at 4.2 K -1.73 mV/K at 77 K -2.3 mV/K at 300 K -2.12 mV/K at 500 K	-148 mV/K at 10 K -1.25 mV/K at 77 K -2.85 mV/K at 300 K -3.15 mV/K at 475 K
<b>Measurement Resolution:</b> Sensor Units Temperature Equivalence	20 $\mu$ V 0.6 mK at 4.2 K 11.6 mK at 77 K 8.7 mK at 300 K 9.4 mK at 500 K	20 $\mu$ V 0.014 mK at 10 K 16 mK at 77 K 7 mK at 300 K 6 mK at 475 K
<b>Electronic Accuracy:</b> Sensor Units Temperature Equivalence	$\pm$ 160 $\mu$ V $\pm$ 0.01% rdg $\pm$ 10 mK at 4.2 K $\pm$ 152 mK at 77 K $\pm$ 94 mK at 300 K $\pm$ 80 mK at 500 K	$\pm$ 160 $\mu$ V $\pm$ 0.02% rdg $\pm$ 3.6 mK at 10 K $\pm$ 244 mK at 77 K $\pm$ 88 mK at 300 K $\pm$ 63 mK at 475 K
<b>Temperature Coefficient</b>	$\pm$ 10 $\mu$ V $\pm$ 5 PPM of reading per $^{\circ}$ C	$\pm$ 20 $\mu$ V $\pm$ 5 PPM of reading per $^{\circ}$ C
<b>Temperature Accuracy</b> including electronic accuracy, CalCurve™ and calibrated sensor	$\pm$ 15 mK at 4.2 K $\pm$ 189 mK at 77 K $\pm$ 129 mK at 300 K $\pm$ 134 mK at 500 K	$\pm$ 9.6 mK at 10 K $\pm$ 281 mK at 77 K $\pm$ 123 mK at 300 K $\pm$ 112 mK at 475 K
<b>Magnetic Field Use</b>	Recommended for $T \geq 60$ K & $B \leq 3$ T	Recommended for $T > 4.2$ K & $B \leq 5$ T



**Table 1-2. Sensor Input Performance Chart (Continued)**

100 Ω Platinum RTD 500 Ω Full Scale	1000 Ω Platinum RTD	Cernox™ RTD CX-1050
Positive	Positive	Negative
ohms (Ω)	ohms (Ω)	ohms (Ω)
0 – 500 Ω	0 – 5000 Ω	0 – 7500 Ω
1 mA ±0.3%	1 mA ±0.3%	10 μA ±0.05%
10 mΩ	100 mΩ	100 mΩ
PT-103 with 14J calibration	PT-1001* with 1.4J calibration	CX-1050-SD with 4L calibration
30 – 800 K	30 – 800 K	3.5 – 400 K
DIN 43760	Scaled from DIN 43670	Requires calibration
0.19 Ω/K at 30 K 0.42 Ω/K at 77 K 0.39 Ω/K at 300 K 0.37 Ω/K at 675 K 0.36 Ω/K at 800 K	1.9 Ω/K at 30 K 4.2 Ω/K at 77 K 3.9 Ω/K at 300 K 3.3 Ω/K at 800 K	1120.8 Ω/K at 4.2 K 2.412 Ω/K at 77 K 0.1727 Ω/K at 300 K
2 mΩ 10.6 mK at 30 K 4.7 mK at 77 K 5.2 mK at 300 K 5.5 mK at 675 K 5.6 mK at 800 K	20 mΩ 10.6 mK at 30 K 10 mK at 77 K 10 mK at 300 K 10 mK at 800 K	50 mΩ 0.045 mK at 4.2 K 21 mK at 77 K 289 mK at 300 K
±0.004 Ω ±0.02% rdg ±25 mK at 30 K ±19 mK at 77 K ±67 mK at 300 K ±146 mK at 675 K ±172 mK at 800 K	±0.06 Ω ±0.04% rdg ±40 mK at 30 K ±33 mK at 77 K ±135 mK at 300 K ±370 mK at 800 K	±0.1 Ω ±0.04% rdg ±2.1 mK at 4.2 K ±38 mK at 77 K ±195 K at 300 K
±0.2 mΩ ±5 PPM of reading per °C	±2.0 mΩ ±5 PPM of reading per °C	±20 mΩ ±15 PPM of reading per °C
±34 mK at 30 K ±29 mK at 77 K ±91 mK at 300 K ±197 mK at 675 K ±223 mK at 800 K	±60 mK at 30 K ±53 mK at 77 K ±170 mK at 300 K ±470 mK at 800 K	±6.1 mK at 4.2 K <sup>†</sup> ±50 mK at 77 K <sup>†</sup> ±242 K at 300 K <sup>†</sup>
Recommended for T > 40 K & B ≤ 2.5 T	Recommended for T > 40 K & B ≤ 2.5 T	Recommended for T > 2 K & B ≤ 19 T

\*No longer available from Lake Shore.

† Specified accuracy includes no effects of thermal EMF voltages.

An error of 3 mΩ results from each 1 μV of thermal EMF voltage.

In well-designed systems, thermal EMF voltage should be <10 μV.

### **1.3 SAFETY SUMMARY**

Observe these general safety precautions during all phases of instrument operation, service, and repair. Failure to comply with these precautions or with specific warnings elsewhere in this manual violates safety standards of design, manufacture, and intended instrument use. Lake Shore Cryotronics, Inc. assumes no liability for Customer failure to comply with these requirements.

The Model 211 protects the operator and surrounding area from electric shock or burn, mechanical hazards, excessive temperature, and spread of fire from the instrument.

The Model 211 is designed for indoor use only. Improper use of the instrument may pose a hazard to the operator and surrounding area.

The power supply included with the Model 211 meets or exceeds the European Union Standard, EN-60950.

#### **Do Not Operate in an Explosive Atmosphere**

Do not operate the instrument in the presence of flammable gases or fumes. Operation of any electrical instrument in such an environment constitutes a definite safety hazard.

#### **Keep Away from Live Circuits**

Operating personnel must not remove instrument covers. Refer component replacement and internal adjustments to qualified maintenance personnel. Do not replace components with power cable connected. To avoid injuries, always disconnect power and discharge circuits before touching them.













#### **Do Not Substitute Parts or Modify Instrument**

Do not install substitute parts or perform any unauthorized modification to the instrument. Return the instrument to an authorized Lake Shore Cryotronics representative for service and repair to ensure that safety features are maintained.

#### **Cleaning**

Do not submerge instrument. Clean only with a damp cloth and mild detergent — exterior only.

#### 1.4 SAFETY SYMBOLS

-  Direct current (power line).
-  Alternating current (power line).
-  Alternating or direct current (power line).
-  Three-phase alternating current (power line).
-  Earth (ground) terminal.
-  Protective conductor terminal.
-  Frame or chassis terminal.
-  On (supply).
-  Off (supply).
-  Equipment protected throughout by double insulation or reinforced insulation (equivalent to Class II of IEC 536 - see Annex H).
-  Caution: High voltages; danger of electric shock. Background color: Yellow; Symbol and outline: Black.
-  Caution or Warning - See instrument documentation. Background color: Yellow; Symbol and outline: Black.
-  Fuse.

This Page Intentionally Left Blank

## CHAPTER 2

# INSTALLATION

### 2.0 GENERAL

This chapter provides general installation instructions for the Model 211 Temperature Monitor. To ensure the best possible performance and to maintain operator safety, please read the entire chapter before installing and operating the instrument. Refer to Chapter 3 for operating instructions. Refer to Chapter 4 for computer interface installation and operation.

### 2.1 INSPECTION AND UNPACKING

Inspect shipping containers for external damage before opening. Photograph any container that has significant damage before opening it. If there is visible damage to the contents of the container, contact the shipping company and Lake Shore immediately, preferably within 5 days of receipt of goods. Keep all damaged shipping materials and contents until instructed to either return or discard them.

Open the shipping container and keep the container and shipping materials until all contents have been accounted for. Check off each item on the packing list as it is unpacked. Instruments may be shipped as several parts. The items included with the Model 211 are listed as follows.

#### **Items Included with Model 211 Temperature Monitor:**

- Model 211 Instrument
- Model 211 User's Manual
- Input/Output Mating Connector and Shell
- Panel Mount Hardware Installed at Factory
- Universal Input Power Supply (interchangeable plug style)
- Cable Clamp
- Rubber Feet

Contact Lake Shore immediately if there is a shortage of parts or accessories. Lake Shore is not responsible for any missing items if not notified within 60 days of shipment.

Inspect all items for both visible and hidden damage that occurred during shipment. If damage is found, contact Lake Shore immediately for instructions on how to file a proper insurance claim. Lake Shore products are insured against damage during shipment but a timely claim must be filed before Lake Shore will take further action. Procedures vary slightly with shipping companies. Keep all shipping materials and damaged contents until instructed to either return or discard them.

*Inspection and Unpacking (Continued)*

If the instrument must be returned for recalibration, replacement or repair, a returned goods authorization (RGA) number must be obtained from a factory representative before it is returned. The Lake Shore RGA procedure is given in Paragraph 5.2.

**2.2 REAR PANEL DEFINITION**

This paragraph describes the connectors on the rear panel of the Model 211. See Figure 2-1. Readers are referred to paragraphs that contain installation instructions and connector pin-outs for each feature. A summary of connector pin-outs is provided in Paragraph 5.5.

**CAUTION:** Only make rear panel connections with power supply disconnected.

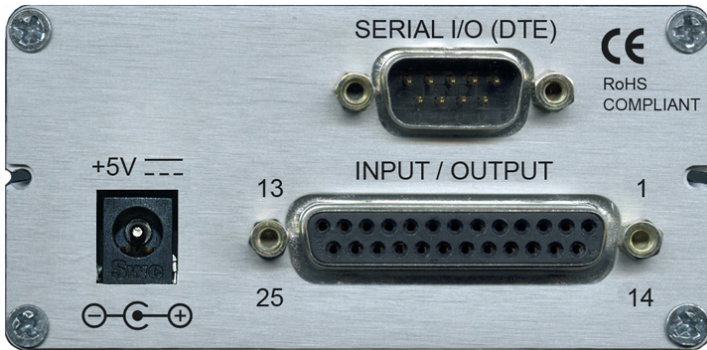

211\_Rear.jpg

	<i>Description</i>	<i>Details</i>
POWER 5V DC	Paragraph 2.3	Figure 5-1
SERIAL I/O (DTE) DE-9	Paragraph 4.1.1	Figure 5-3
INPUT/OUTPUT DB-25	Paragraph 2.6.1	Figure 5-2

**Figure 2-1. Model 211 Rear Panel**

**2.3 POWER INPUT CONNECTOR**

Power is supplied to the Model 211 through a coaxial connector located on the rear panel of the instrument. There is no power switch on the instrument, so it is off when not plugged in, or on when plugged in. Make sensor connections before applying power to the instrument.

**Power Input Connector (Continued)**

The instrument requires +5 VDC at 400 mA. The coaxial connector accepts a barrel plug 5.5mm OD x 2.1mm ID x 9.9mm L. Refer to Figure 2-2 for polarity.

**WARNING:** To prevent electrical fire or shock hazards, do not expose this instrument, or its power supply, to rain or excess moisture.

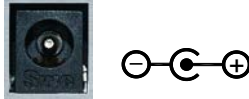

**Figure 2-2. Power Connector**

**2.4 EXTERNAL POWER SUPPLY**

The Model 211 comes with the universal input power supply, Lake Shore P/N 109-132. It can accept input voltages from 100 to 240 VAC ( $\pm 10\%$ ), 50 to 60 Hz. For input power, it has interchangeable plugs to accommodate power receptacles in different countries. It has a barrel plug for the output. It can output +5 V at 0 to 1.2 A. The power supply is CE certified and meets or exceeds the following safety standards: UL 60950-1 and EN 60950. To change plugs, press the pad on the side of the plug, pull off the old plug and snap in the new plug.

**2.5 CABLE CLAMP**

To avoid inadvertent disconnection from the power supply, Lake Shore supplies a cable clamp that the user may attach to the cord and the instrument chassis. It is a part of the accessories kit supplied with the unit. To install the clamp, remove the screw at the top left rear of the unit, position the cord and clamp as shown in the photo and reinstall the screw.



**2.6 SENSOR INPUT**

This paragraph details how to connect diode and resistor sensors to the Model 211 input. Refer to Paragraph 3.5 to configure the input. Sensor installation instructions are provided in the Lake Shore Temperature Measurement and Control Catalog.

### 2.6.1 Input/Output Connector

Sensors are connected to the Model 211 through the Input/Output connector on the rear panel of the instrument. The Input/Output connector is also used for the analog output and relay connections. Refer to Figure 2-3 for pin descriptions.

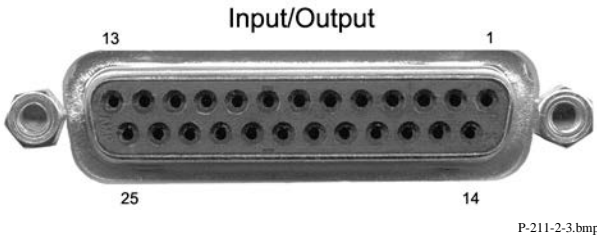

P-211-2-3.bmp

Pin	Description	Pin	Description
1	No Connection	—	—
2	Shield	14	Shield
3	I+	15	I-
4	V+	16	V-
5	Shield	17	Shield
6	Analog Output Signal	18	Analog Output Ground
7	No Connection	19	No Connection
8	Low Alarm COM	20	Low Alarm NO
9	Low Alarm NC	21	No Connection
10	No Connection	22	No Connection
11	High Alarm COM	23	High Alarm NO
12	High Alarm NC	24	No Connection
13	No Connection	25	No Connection

Figure 2-3. Input/Output Connector

### 2.6.2 Sensor Lead Cable

The sensor lead cable used outside the cooling system can be much different from what is used inside. Between the instrument and vacuum shroud, heat leak is not a problem, but errors from noise pick up need to be minimized. Larger conductor, 22 to 28 AWG stranded copper wire is recommended because it has low resistance yet remains flexible when several wires are bundled in a cable.



*Sensor Lead Cable (Continued)*

The arrangement of wires in a cable is also important. For best results, twist voltage leads, V+ and V- together and twist current leads I+ and I- together. Cover the twisted pairs of voltage and current leads with a braided or foil shield connected to the shield pin of the instrument. This type of cable is available through local electronics suppliers. Instrument specifications are given assuming 10 feet of sensor cable. Longer cables, 100 feet or more, can be used but environmental conditions may degrade accuracy and noise specifications.

**2.6.3 Shielding Sensor Leads**

Shielding the sensor lead cable is important to keep external noise from entering the measurement. The sensor lead cable should be shielded whenever possible. In many systems, it is impractical to shield the sensor leads inside the cryostat. In these cases, the cable shield should still be used on the room temperature sensor leads up to the cryostat.

A shield is most effective when it is near the measurement potential, so the Model 211 offers a shield pin on the Input/Output Connector that stays close to the measurement. The shield pin is tied to chassis ground and should be used as the connection point for the sensor cable shield. Depending on how the instrument is grounded, the shield may or may not need to be terminated at the opposite end. See Paragraph 2.6.4 below on instrument grounding.

**2.6.4 Instrument Grounding**

The Model 211 does not provide isolation between measurement circuits and chassis ground. The measurement leads have a finite impedance to chassis ground and should not be tied to ground outside the instrument or an error in reading may result. The Model 211 has the best noise performance when the chassis is tied to earth ground. This connection should be made at only one point so as to avoid ground loops.

If the sensor leads are shielded, the cable shield should be tied to the shield pins on the Input/Output connector but should not be terminated at the other end.

The standard power supply (109-132) does not connect the common pins to earth ground. The connection should be made externally. If the sensor leads are shielded, one end of the cable shield can be tied to the cryostat ground while the other end is tied to the shield pins on the Input/Output connector. If the sensor leads are not shielded, the instrument chassis should be strapped to earth ground.

### 2.6.5 Sensor Polarity

Lake Shore sensors ship with instructions that indicate which sensor leads are which. It is important to follow these instructions for plus and minus leads (polarity) as well as voltage and current when applicable. Diode sensors do not operate in the wrong polarity. They look like an open circuit to the instrument. 2-lead resistors can operate with any lead arrangement and the sensor instructions may not specify polarity. 4-lead resistors may depend more on lead arrangement. Follow any specified lead assignment for four lead resistors. Mixing leads could give a reading that appears correct, but is not the most accurate.

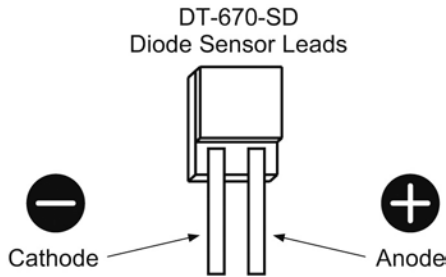

### 2.6.6 4-Lead Sensor Measurement

All sensors, including both 2-lead and 4-lead can be measured with a 4-lead technique. 4-lead measurement eliminates the effect of lead resistance on the measurement. If it is not taken out, lead resistance is a direct error when measuring a sensor.

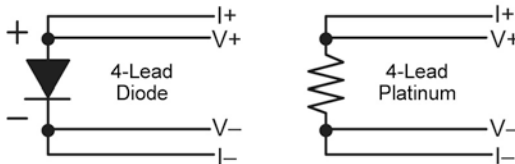

In a 4-lead measurement, current leads and voltage leads run separately to the sensor. With separate leads, there is little current in the voltage leads so their resistance does not enter into the measurement. Resistance in the current leads will not change the current as long as the voltage compliance of the current source is not reached. When 2-lead sensors are used in 4-lead measurements, the short leads on the sensor have an insignificant resistance.

### 2.6.7 2-Lead Sensor Measurement

Sometimes a crowded cryogenic system forces users to read sensors in a 2-lead configuration because there are not enough feedthroughs or room for lead wires. If this is the case, plus voltage to plus current and minus voltage to minus current leads are attached at the back of the instrument or at the vacuum feedthrough.

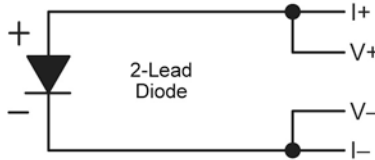

The error in a resistive measurement is the resistance of the lead wire run with current and voltage together. If the leads contribute 2 or 3  $\Omega$  to a 5 k $\Omega$  reading, the error can probably be tolerated. When measuring voltage for diode sensors the error in voltage can be calculated as the lead resistance times the current, typically 10  $\mu\text{A}$ . For example: a 10  $\Omega$  lead resistance times 10  $\mu\text{A}$  results in a 0.1 mV error in voltage. Given the sensitivity of a silicon diode at 4.2 K the error in temperature would be only 3 mK. At 77 K the sensitivity of a silicon diode is lower so the error would be close to 50 mK. Again, this may not be a problem for every user.

### 2.6.8 Lowering Measurement Noise

Good instrument hardware setup technique is one of the least expensive ways to reduce measurement noise. The suggestions fall into two categories: (1) Do not let noise from the outside enter into the measurement, and (2) Let the instrument hardware features work to their best advantage.

- Use 4-lead measurement whenever possible.
- Do not connect sensor leads to chassis or earth ground.
- Use twisted shielded cable outside the cooling system.
- Attach the shield pin on the sensor connector to the cable shield.
- Do not attach the cable shield at the other end of the cable, not even to ground without taking precautions to prevent ground loops.
- Run different inputs and outputs in their own shielded cable.
- Use twisted wire inside the cooling system.
- Consider ground strapping the instrument chassis to other instruments or computers.

## 2.7 ANALOG OUTPUT

The Analog Output available on the rear panel of the Model 211 can be configured as either a voltage or current output that can be used for monitor and control applications. Its most basic function is a temperature monitor where it puts out a voltage or current that is proportional to temperature. Refer to Paragraph 3.8 to configure the analog output.

In voltage mode the analog output can vary from 0–10 V with a resolution of 0.15 mV or 0.0015% of full scale. The output can drive a resistive load of no less than 500  $\Omega$ . The output is short-circuit protected so the instrument is not harmed if the load resistance is too small. However, this practice is not recommended as the additional load on the instrument power supply causes noise on internal circuits.

In current mode, the analog output can vary from 4 to 20 mA with a resolution of 0.3  $\mu$ A or 0.0015% of full scale. The output is limited by a 10 V compliance voltage so the largest resistive load that the output can drive in current mode is 500  $\Omega$ .

The output for the analog output is available from Pins 6 and 18 of the Input/Output connector. See Figure 2-3. The terminal marked analog output signal is the output voltage terminal; the terminal marked analog output ground is the ground and is attached to chassis ground inside the instrument.

It is not recommended to attach the analog output ground to a ground outside the instrument. The output should be read by an instrument with an isolated or differential input wherever possible. Connecting to an external ground can cause noise in the analog output voltage or the sensor input measurement. If this cannot be avoided, try to keep the chassis of the two instruments at the same potential with a ground strap.

## 2.8 RELAYS

The Model 211 has two relays, labeled high and low. The relays are most commonly associated with the alarm feature. The relays can also be placed in manual mode and controlled directly by the user from the front panel or over the computer interface. Refer to Paragraph 3.7 and the RELAY command in Chapter 4.

Normally Open (NO), Normally Closed (NC), and Common (COM) contacts are available for each relay. All contacts (including common) are isolated from the measurement and chassis grounds of the instrument. If a relay is inactive (Off), it will be in its normal state of open or closed. When the relay is active (On), it will be in the opposite state. Relay connections are available on the Input/Output connector. See Figure 2-3.

## 2.9 PANEL MOUNTING

The Model 211 can be easily panel mounted using the panel mount brackets included. The Model 211 fits in a  $91 \times 44$  mm ( $3.6 \times 1.7$  in) cutout. To panel-mount the instrument, unplug the unit and use a  $\frac{1}{16}$ -inch hex wrench to remove the two set screws holding the brackets in place. Remove the two panel mount brackets by sliding them towards the rear of the unit. Place the unit into the panel cutout. Slide the two panel mount brackets back into the case of the instrument. Reinstall the two set screws and tighten them until the instrument is secure.

The Model 211 can also be purchased with either of two panel mount adapters. The Model 2111 or 2112 will mount one or two temperature monitors in a  $\frac{1}{4}$ -DIN cutout measuring 105 mm wide  $\times$  132 mm high ( $4.1 \times 5.2$  in). See Figure 2-5.

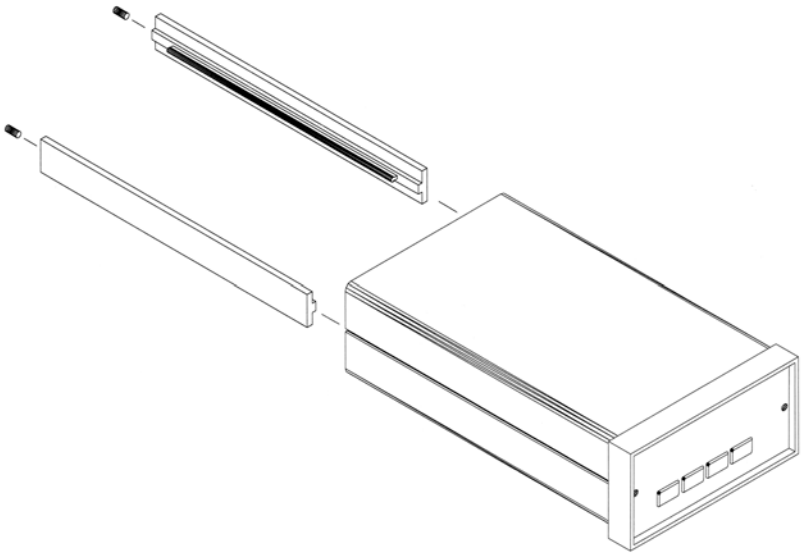

Panel.bmp

**Figure 2-4. Panel Mounting Details**

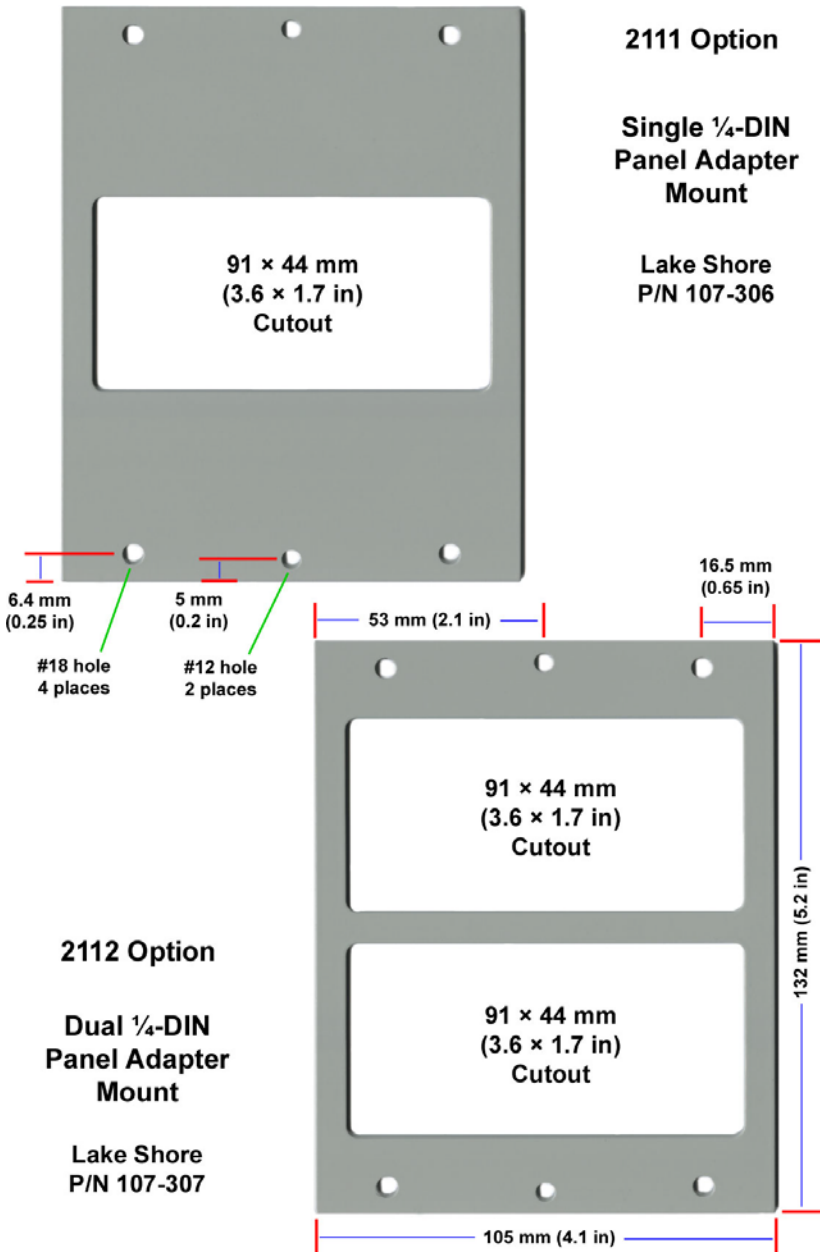

Figure 2-5. 2111 and 2112 Panel Mount Adapters

## CHAPTER 3

# OPERATION

### 3.0 GENERAL

This chapter provides operating instructions for most features of the Model 211 Temperature Monitor. Corresponding computer interface instructions for these features are provided in Chapter 4.

### 3.1 INSTRUMENT POWER

The Model 211 is powered on by plugging in the power supply. There is no power switch on the instrument. When the Model 211 is powered on, every segment on the display will illuminate for a few seconds to indicate instrument initialization. Most of the instrument setup parameter values are retained when powered off with one exception. The latching alarm will reset itself on power-up. When the instrument is powered on for the first time, parameter values are set to their defaults, listed in Table 3-6.

When initialization is complete, the instrument will begin its normal reading cycle and temperature or sensor units readings should appear on the display. Messages will appear in the reading location on the display if the measurement input has not been fully configured. Messages listed in Paragraph 5.3.1, Instrument Hardware Errors, are related to the instrument hardware, and may require help from Lake Shore service. The messages listed in Paragraph 5.3.2, Limit Errors, do not indicate a problem with the instrument, and will disappear when input setup is complete.

The Model 211 should be allowed to warm up for a minimum of 30 minutes to achieve rated accuracy.

### 3.2 DISPLAY DEFINITION

The Model 211 has a 6-digit LED display capable of showing both numeric and character data. In normal operation, the display shows the current sensor reading in sensor units or temperature units. The four annunciators below the right hand side of the display indicate what units the display is reading. Other display configurations appear during parameter setting and data entry operations. These displays are illustrated in their individual operation paragraphs.

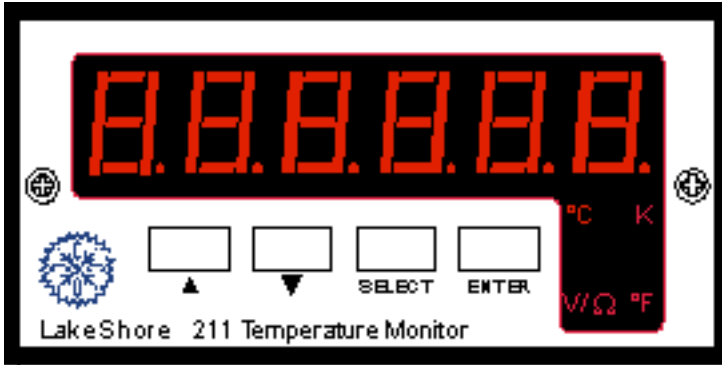

**Figure 3-1. Model 211 Display**

### 3.3 LED ANNUNCIATORS AND DISPLAY MESSAGES

The display units are indicated using LED annunciators below the right side of the main display.

#### LED Annunciators

- °C     The display units are in degrees Celsius.
- K       The display units are in kelvin.
- °F     The display units are in degrees Fahrenheit.
- V/Ω    The display units are in sensor units, either volts or ohms, depending on input type.

Alarm messages are displayed alternately with the reading when an alarm condition exists. If both a high and low alarm condition exists (can only happen when latching alarms are active), then the display will alternate between the current reading and the alarm high and alarm low messages. Other display messages are described throughout this chapter.

#### Alarm Messages

- ALA K   Indicates that the high alarm is active.
- ALA L   Indicates that the low alarm is active.



### 3.4 KEYPAD DEFINITION

The Model 211 has four keys on the front panel to setup instrument functions. A list of front panel setup operations is shown in the Model 211 Menu Structure located on the inside back cover of this manual.

#### 3.4.1 Key Descriptions

- s** The up arrow serves two functions: to choose between parameters during setting operations and to increment numerical data. Holding the button in while setting numerical data increases setting speed.
- t** The down arrow serves two functions: to choose between parameters during setting operations and to decrement numerical data. Holding the button in while setting numerical data increases setting speed.
- Select** Places the instrument into settings mode where all instrument parameters can be setup. When pressed while in the settings mode, it terminates the settings mode without changing the existing parameter value. Press and hold to display code revision date.
- Enter** Completes setting function storing any changes to the parameter value. Press and hold to lock or unlock the keypad.

#### 3.4.2 General Keypad Operation

The Model 211 has two keypad operations: setting selection and data entry.

**Setting Selection:** Allows the user to select from a finite list of parameter values. During setting selection, the **s** and **t** keys are used to select a parameter value. **Enter** is used to accept the change and advance to the next parameter. **Select** will cancel the change to that parameter and return to the normal display.

**Data Entry:** Allows the user to enter numeric parameter values using the **s** and **t** keys. Press the **s** key to increase the value of the setting, or press the **t** key to decrease its value. Holding either key down for a few seconds will cause the number to change at a faster rate. Once the correct parameter value is entered, press **Enter** to accept the change and advance to next parameter. Pressing **Select** will cancel the change to that parameter and return to the normal display.

Related setting selection and data entry sequences are often chained together under a single setting sequence. To skip over a parameter without changing its value press **Enter** before pressing an arrow key. To return to the normal display in the middle of a setting sequence press **Select** before pressing an arrow key. Changes “entered” before **Select** is pressed are kept.

### 3.5 INPUT SETUP

#### 3.5.1 Input Type

The Model 211 supports a variety of temperature sensors sold by Lake Shore and other manufactures. An appropriate sensor type must be selected for the input. Refer to Table 3-1 for a list of common sensor types. If a particular sensor is not listed in the Input Type selection, look at Table 3-1 to find a sensor with similar range and excitation. For additional details on sensors, refer to the Lake Shore Temperature Measurement and Control Catalog or visit our website at [www.lakeshore.com](http://www.lakeshore.com).

To select sensor type, press the **Select** key, use the **s** or **t** keys to select “InPUt”, then press the **Enter** key. Use the **s** or **t** keys to cycle through the sensor types shown in Table 3-1. When the desired type appears, press the **Enter** key. Proceed to Paragraph 3.5.2 to select a temperature curve or press the **Select** key to return to the normal display.

**Table 3-1. Sensor Input Types**

Display Message	Input Type	Excitation	Sensor Type	Curve Format	Coefficient	Lake Shore Sensors*
Si	2.5 V	10 $\mu$ A	Silicon Diode	V/K	Neg.	DT-470, DT-670
GAALAS	7.5 V	10 $\mu$ A	Gallium-Aluminum-Arsenide Diode	V/K	Neg.	TG-120 Series
250 Pt	250 $\Omega$	1 mA	100 $\Omega$ Platinum RTD <675 K; Rhodium-Iron RTD	$\Omega$ /K	Pos.	PT-100 Series Platinum, RF-800 Rhodium-Iron
500 Pt	500 $\Omega$	1 mA	100 $\Omega$ Platinum RTD >675 K			
1000Pt	5000 $\Omega$	1 mA	1000 $\Omega$ Platinum RTD	$\Omega$ /K	Pos.	—
ntcrtd	7500 $\Omega$	10 $\mu$ A	Negative Temperature Coefficient (NTC) RTD	log $\Omega$ /K	Neg.	Cernox™, High-Temp Cernox™, Carbon-Glass, Rox™, and Thermox™

\* Refer to the Lake Shore Temperature Measurement and Control Catalog for complete details on all Lake Shore Temperature Sensors.

### 3.5.2 Curve Selection

The Model 211 supports a variety of temperature sensors sold by Lake Shore and other manufacturers. After the appropriate sensor type is selected for the input (Paragraph 3.5.1), an appropriate temperature response curve may be selected. The Model 211 can use curves from several sources. Standard curves are included with every instrument and numbered 1 through 7. A single user curve can be loaded via the serial interface when a sensor does not match a standard curve. CalCurve option can be stored as the user curve at the factory or by the customer. The complete list of standard curves built in to the Model 211 is provided in Table 3-2. Curve tables are listed in Appendix A of this manual.

During normal operation, only the curves related to the input type selected are displayed. If the curve you wish to select does not appear in the selection sequence make sure the curve format matches the recommended format for the input type selected. Refer to Table 3-1.

**NOTE:** The sensor reading can always be displayed in sensor units. If a temperature response curve is selected for an input, its readings may also be displayed in temperature.

To select a curve, continue from the input type selection (Paragraph 3.5.1) or press the **Select** key, use the **s** or **t** key to select "InPUt", then press the **Enter** key twice. The display will show the curve currently assigned to the input. If no curve is attached "nonE" will be displayed. Use the **s** or **t** keys to cycle through the temperature response curves. When the desired type appears, press the **Enter** key. Proceed to Paragraph 3.5.3 to select the display units or press the **Select** key to return to the normal display.

**Table 3-2. Standard Curves**

Curve No.	Display Name	Sensor Type	Lake Shore Sensor	Curve Name	Temperature Range
0	nonE	None	None	None	None
1	dt470	Silicon Diode	DT-470	Curve 10	1.4–475 K
2	dt670	Silicon Diode	DT-670	DT-670	1.4–500 K
3	[ti	Silicon Diode	N/A	CTI Curve C	10–320 K
6	Pt 100	100 Ω Platinum RTD	PT-100	DIN 43760	30–800 K
7	PT1000	1000 Ω Platinum RTD	N/A	DIN 43760	30–800 K
21	USEr	User defined	—	User defined	User defined

### 3.5.3 Display Units Selection

The Model 211 has a 6-character LED display. During normal operation it can display the sensor reading in temperature (kelvin, Celsius, or Fahrenheit) or sensor units (V or  $\Omega$ ). The LEDs to the right of the keys indicate what units are being displayed.

To select display units, continue from input curve selection (Paragraph 3.5.2) or press the **Select** key, use the **s** or **t** key to select "InPUt," then press the **Enter** key three times. The display shows "UnitS" and a LED shows the selected display units. Use the **s** or **t** key to cycle through the display units. When the desired unit is highlighted, press the **Enter** key.

### 3.6 ALARM SETUP AND OPERATION

The input of the Model 211 has high and low alarm capability. Temperature reading data in kelvin can be compared to the alarm setpoint values. A reading higher than the high setpoint or off the high end of the temperature curve triggers the high alarm and a reading lower than the low alarm setpoint or off the low end of the temperature curve triggers the low alarm.

**NOTE:** Alarm setpoints are always set in K, but the alarm feature will still operate if the instrument displays °C or °F. If no temperature response curve is chosen, the alarm function will not operate. Refer to Paragraph 3.5.2 for curve selection.

If an alarm activates for the input, the display flashes between the current reading and "ALA K" or "ALA L" for high and low alarms respectively. The two relays can also be tied to alarm functions (refer to Paragraph 3.7).

**Latching Alarms.** Often used to detect faults in a system or experiment that require operator intervention. The alarm state remains visible to the operator for diagnostics even if the alarm condition is removed. Relays often signal remote monitors or for added safety take critical equipment off line. Pressing the **Select** key clears latched alarms.

**Non-Latching Alarms.** Often tied to relay operation to control part of a system or experiment. The dead band parameter can prevent relays from turning on and off repeatedly when the sensor input reading is near an alarm setpoint. **Example:** If the high alarm setpoint = 100 K and the dead band = 1 K, the high alarm triggers when sensor input temperature increases to 100 K, and it will not deactivate until temperature drops to 99 K.

To begin alarm setup press the **Select** key and use the **s** or **t** key to select "ALA" and press the **Enter** key. Use the **s** or **t** key to turn the alarm function on or off. If the alarm function is powered on, the alarm will continue with alarm setup otherwise no other settings need to be made and the display will return to normal operation.

*Alarm Setup and Operation (Continued)*

The next setting is the high alarm point indicated by a “K” on the left of the display. The high alarm setpoint is always set in units of kelvin. Use the **s** or **t** key to set the high alarm setpoint. Holding the button in will increase the rate of change. The minimum value is 0 K and the highest is 999.9 K. Press the **Enter** key to store the high alarm setpoint.

The next setting is the low alarm setpoint indicated by a “L” on the left of the display. Its setting is similar to the high alarm setpoint listed above. Press the **Enter** key to store the low alarm setpoint.

The next setting is the alarm deadband indicated by a “d” on the left of the display. Its setting is similar to the high and low alarm point settings except that the maximum value that can be set is 99.9 K. Press the **Enter** key to store the alarm deadband.

The final setting is alarm latching. The display will show “LtCH” along with the setting, 0 indicating that the latch function is turned off and a 1 indicating that it is turned on. Use the **s** or **t** key to set the alarm latching status. Press the **Enter** key to store the alarm latching status. The display will return to normal operation.

### 3.7 RELAY SETUP

There are two relays on the Model 211 numbered 1 and 2. They are most commonly thought of as alarm relays, but they may be manually controlled. The relays are rated for 30 VDC and 1 A. The terminals are in the Input/Output connector on the Model 211 rear panel. See Figure 2-3.

When using relays with alarm operation, set up the alarms first (Paragraph 3.6). Relay 1 is tied to the low alarm operation and relay 2 is tied to the high alarm operation.

To begin relay setup press the **Select** key and use the **s** or **t** key to select “rELAy” and press the **Enter** key. Relay 1 will be setup first indicated by the “r1” on the left of the display. Use the **s** or **t** key to select the function of relay 1 from manually off (r1 OFF), manually on (r1 0n), or following the low alarm (r1 ALA). If the relay is set to follow the alarm, it will turn on when the temperature drops below the low alarm setpoint. Press the **Enter** key to store the relay setting.

The next setting is the relay 2 setup indicated by the “r2” on the left of the display. Use the **s** or **t** key to select the function of relay 2 from manually off (r2 OFF), manually on (r2 0n), or following the high alarm (r2 ALA). If the relay is set to follow the alarm, it will turn on when the temperature goes above the high alarm setpoint. Press the **Enter** key to store the relay setting. The display will return to normal operation.

### 3.8 ANALOG OUTPUT SETUP

The Model 211 has a single analog output. It is normally configured to provide an analog signal proportional to temperature to a strip chart recorder or separate data acquisition system. Pins 6 and 18 on the DB-25 Input/Output connector are used for the analog output. See Figure 2-3.

The analog output is front panel configurable to be either a variable DC voltage or current source. In voltage mode, the analog output can vary from 0 to 10 V with a resolution of 0.15 mV or 0.0015% of full scale. The output can drive a resistive load of no less than 500  $\Omega$ . The output is short-circuit protected so the instrument is not harmed if the load resistance is too small. However, this practice is not recommended as the additional load on instrument power supplies causes noise on internal circuits.

In current mode the analog output can vary from 4 to 20 mA with a resolution of 0.2  $\mu$ A or 0.0015% of full scale. The output is limited by a 10 V compliance voltage so the largest resistive load that the output can drive in current mode is 500  $\Omega$ .

The analog output has two modes, voltage and current, and six ranges. The ranges are listed in Table 3-3. The low output is the temperature that produces zero output (0 V or 4 mA) and the high output is the temperature that produces full output (10 V or 20 mA).

If no curve is selected for the input, the analog output range is fixed to output a signal proportional to sensor units. Refer to Table 3-4.

**NOTE:** When a curve is selected for the input, the analog output always works in kelvin no matter what units are displayed.

To begin analog output setup press the **Select** key and use the **s** or **t** key to select "OUtPUt" and press the **Enter** key. Analog output mode will be set up first. Use the **s** or **t** key to choose between voltage mode or current mode. Press the **Enter** key to store the analog output mode.

The next setting is analog output range. Refer to Table 3-3 and use the **s** or **t** key to select a range for the analog output. Press the **Enter** key to store the analog output range. The display will return to normal operation.

Analog Output Setup (Continued)

**Table 3-3. Analog Output Range Scales**

Range Number	Low Output	High Output
0	0 K	20 K
1	0 K	100 K
2	0 K	200 K
3	0 K	325 K
4	0 K	475 K
5	0 K	1000 K

**Table 3-4. Analog Output Scales In Sensor Units**

Input Type	Low Output	High Output
Silicon Diode	0 V	10 V
GaAlAs Diode	0 V	10 V
PT-100, 250 Ω	0 Ω	1 kΩ
PT-100, 500 Ω	0 Ω	1 kΩ
PT-1000	0 Ω	10 kΩ
NTC RTD	0 Ω	10 kΩ

**3.9 ANALOG OUTPUT TO TEMPERATURE CONVERSION**

The output current or voltage is directly proportional to the temperature reading. For the 4–20 mA output, the following formula converts output current to temperature:

$$T = A + B \times I_{OUT}$$

where T = temperature in kelvin,  $I_{OUT}$  = output current in mA, and A and B are constants from Table 3-5.

For the 0–10 V output, the following formula converts output voltage to temperature:

$$T = C \times V_{OUT}$$

where T = temperature in kelvin,  $V_{OUT}$  = output voltage, and C is a constant from Table 3-5.

**Table 3-5. Conversion Parameters for Temperature in K**

RANGE	TEMP. (K)	4 – 20 mA		0 – 10 V
		A (K)	B (K/mA)	C (K/V)
0	0 – 20	-5.00	1.2500	2.0
1	0 – 100	-25.00	6.2500	10.0
2	0 – 200	-50.00	12.5000	20.0
3	0 – 325	-81.25	20.3125	32.5
4	0 – 475	-118.75	29.6875	47.5
5	0 – 1000	-250.00	62.5000	100.0

### 3.10 LOCKING AND UNLOCKING THE KEYPAD

The keypad lock feature prevents accidental changes to parameter values. When the keypad is locked, only the alarm reset function of the **Select** key still functions. All other key functions are ignored.

To lock the keypad, press and hold the **Enter** key for 10 seconds. The display will show “LO[” indicating the keypad is now locked. Release the **Enter** key and the display will return to normal operation.

To unlock the keypad, press and hold the **Enter** key for 10 seconds. The display will show “UnLO[” indicating the keypad is now unlocked. Release the **Enter** key and the display will return to normal operation.

### 3.11 RESETTING THE MODEL 211 TO DEFAULT VALUES

It is sometimes necessary to reset instrument parameters that are stored in nonvolatile memory called EEPROM. The default values of the Model 211 are shown below in Table 3-6. Resetting to default values does not affect the user curve or the calibration data.

To reset the Model 211 to default values, press and hold both the **S** or **T** keys for 10 seconds. All of the LED digits will illuminate when the memory has been reset. Release the buttons and the display will return to normal operation.

**Table 3-6. Model 211 Default Values**

Parameter	Default	Parameter	Default
Input Type	Silicon Diode	Alarm Latch	Off
Input Curve	DT-470	Analog Mode	Voltage
Display Units	K	Analog Range	5
Alarm Function	Off	Relay 1 Mode	Off
Alarm High	0 K	Relay 2 Mode	Off
Alarm Low	0 K	Keypad Lock	Unlocked
Alarm Deadband	0 K	Display Brightness	8

### 3.12 CHECKING CODE DATE REVISION

To check revision date of the firmware code, press and hold the **Select** key until the display shows the code date. It is in the format of MMDDYY, where MM is the month, DD is the day, and YY is the year of the code. Release the key and the display returns to normal operation.



### 3.13 CURVE ENTRY AND STORAGE

The Model 211 has standard curve locations numbered 1 through 20. At present, not all locations are occupied by curves; the others are reserved for future updates. Standard curves cannot be changed by the user, and reserved locations are not available for user curves.

The Model 211 has one user curve location. The user curve can only be entered using the serial interface. Refer to Paragraph 4.2 for the serial interface curve commands. The user curve location can hold from 2 to 200 data pairs (breakpoints) including a value in sensor units and a corresponding value in kelvin.

#### 3.13.1 Curve Header Parameters

Each curve has a set of parameters that are used for identification and to allow the instrument to use the curve effectively. The parameters must be set correctly before a curve can be used for temperature conversion.

**Curve Number:** 1–21. Location 21 is for the user curve.

**Name:** Up to a 15-character name can be entered.

**Serial Number:** Up to a 10-character sensor serial number consisting of both numbers and letters.

**Format:** The format parameter tells the instrument what breakpoint data format to expect. Different sensor types require different formats. Formats for Lake Shore sensors are:

**V/K:** Volts vs. kelvin for diode sensors.

**$\Omega$ /K:** Resistance vs. kelvin for platinum RTD sensors.

**Log  $\Omega$ /K:** Log resistance vs. kelvin for NTC resistive sensors.

**Limit:** Temperature limit in kelvin for the curve. Default is 375 K. This limit is not used in this instrument but is left in to be compatible with Lake Shore temperature controllers.

**Temperature Coefficient:** The unit derives the temperature coefficient from the first two breakpoints. The coefficient sent by the user is ignored. If it is not correct when the curve header is queried, check for proper entry of those points. A positive coefficient (**P**) indicates that the sensor signal increases with increasing temperature. A negative coefficient (**N**) indicates that the sensor signal decreases with increasing temperature. The power must be cycled or the \*RST command issued for the instrument to calculate the temperature coefficient after curve points have been entered.

### 3.13.2 Curve Breakpoints

Temperature response data of a calibrated sensor must be reduced to a table of breakpoints before entering it into the instrument. Each breakpoint consists of one value in sensor units and one temperature value in kelvin. Linear interpolation is used by the instrument to calculate temperature between breakpoints. From 2 to 200 breakpoints can be entered as a curve. The instrument will show an error message on the display if the sensor input is outside the range of the breakpoints. No special endpoints are required. Sensor units are defined by the format setting in Table 3-7.

Breakpoint setting resolution is six digits in temperature. Most temperature values are entered with 0.001 resolution. Temperature values of 1000 K and greater can be entered to 0.01 resolution. Temperature values below 10 K can be entered with 0.0001 resolution. Temperature range for curve entry is 1500 K.

Setting resolution is also 6 digits in sensor units. The curve format parameter defines the range and resolution in sensor units as shown in Table 3-7. The sensor type determines the practical setting resolution. Table 3-7 lists recommended sensor units resolutions. For most sensors, additional resolution is ignored.

The breakpoints should be entered with the sensor units value increasing as point number increases. There should not be any breakpoint locations left blank in the middle of a curve. The search routine in the Model 211 interprets a blank breakpoint as the end of the curve.

**Table 3-7. Recommended Curve Parameters**

Type	Typical Lake Shore Model	Unit	Format	Limit (K)	Coefficient	Recommended Sensor Resolution
Silicon Diode	DT-470	V	V/K	475	Negative	0.00001 (V)
GaAlAs Diode	TG-120	V	V/K	325	Negative	0.00001 (V)
Platinum 100	PT-100	$\Omega$	$\Omega$ /K	800	Positive	0.001 ( $\Omega$ )
Platinum 1000	PT-100	$\Omega$	$\Omega$ /K	800	Positive	0.01 ( $\Omega$ )
Rhodium-Iron	RF-100	$\Omega$	$\Omega$ /K	325	Positive	0.001 ( $\Omega$ )
Carbon-Glass	CGR-1-1000	$\Omega$	$\log\Omega$ /K	325	Negative	0.00001 ( $\log\Omega$ )
Cernox™	CX-1030	$\Omega$	$\log\Omega$ /K	325	Negative	0.00001 ( $\log\Omega$ )
Germanium	GR-200A-100	$\Omega$	$\log\Omega$ /K	325	Negative	0.00001 ( $\log\Omega$ )
Rox™	RX-102A	$\Omega$	$\log\Omega$ /K	40	Negative	0.00001 ( $\log\Omega$ )

## CHAPTER 4

# REMOTE OPERATION

### 4.0 GENERAL

The Model 211 is equipped with an RS-232C serial computer interface. The interface allows computer automation of instrument setup and temperature measurement data collection. Nearly every feature of the instrument can be accessed through the computer interface. Interface capabilities including setup information and example programs are provided in Paragraph 4.1. Interface commands including a command summary are described in Paragraph 4.2.

### 4.1 SERIAL INTERFACE OVERVIEW

The serial interface used in the Model 211 is commonly referred to as an RS-232C interface. RS-232C is a standard of the Electronics Industries Association (EIA) that describes one of the most common interfaces between computers and electronic equipment. The RS-232C standard is quite flexible and allows many different configurations. However, any two devices claiming RS-232C compatibility cannot necessarily be plugged together without interface setup. The remainder of this paragraph briefly describes the key features of a serial interface that are supported by the instrument. A customer supplied computer with similarly configured interface port is required to enable communication.

#### 4.1.1 Physical Connection

The Model 211 has a 9-pin D-Subminiature plug on the rear panel for serial communication. The original RS-232C standard specifies 25 pins but both 9- and 25-pin connectors are commonly used in the computer industry. Many third party cables exist for connecting the instrument to computers with either 9- or 25-pin connectors. Section 5.3 gives the most common pin assignments for 9- and 25-pin connectors. Please note that not all pins or functions are supported by the Model 211.

The instrument serial connector is the plug half of a mating pair and must be matched with a socket on the cable. If a cable has the correct wiring configuration but also has a plug end, a “gender changer” can be used to mate two plug ends together.

*Physical Connection (Continued)*

The letters DTE near the interface connector stand for Data Terminal Equipment and indicate the pin connection of the directional pins such as transmit data (TD) and receive data (RD). Equipment with Data Communications Equipment (DCE) wiring can be connected to the instrument with a straight through cable. As an example, pin 3 of the DTE connector holds the transmit line and pin 3 of the DCE connector holds the receive line so the functions complement.

It is likely both pieces of equipment are wired in the DTE configuration. In this case, pin 3 on one DTE connector (used for transmit) must be wired to pin 2 on the other (used for receive). Cables that swap the complementing lines are called null modem cables and must be used between two DTE wired devices. Null modem adapters are also available for use with straight through cables. Paragraph 5.5.1 illustrates suggested cables that can be used between the instrument and common computers.

The instrument uses drivers to generate the transmission voltage levels required by the RS-232C standard. These voltages are considered safe under normal operating conditions because of their relatively low voltage and current limits. The drivers are designed to work with cables up to 50 feet in length.

#### **4.1.2 Hardware Support**

The Model 211 interface hardware supports the following features. Asynchronous timing is used for the individual bit data within a character. This timing requires start and stop bits as part of each character so the transmitter and receiver can resynchronize between each character. Half duplex transmission allows the instrument to be either a transmitter or a receiver of data but not at the same time. The serial output supports a communication speed of 9600 baud.

Hardware handshaking is not supported by the instrument. Handshaking is often used to guarantee that data message strings do not collide and that no data is transmitted before the receiver is ready. In this instrument appropriate software timing substitutes for hardware handshaking. User programs must take full responsibility for flow control and timing as described in Paragraph 4.1.5.

### 4.1.3 Character Format

A character is the smallest piece of information that can be transmitted by the interface. Each character is 10 bits long and contains data bits, bits for character timing and an error detection bit. The instrument uses 7 bits for data in the ASCII format. One start bit and one stop bit are necessary to synchronize consecutive characters. Parity is a method of error detection. One parity bit configured for odd parity is included in each character.

ASCII letter and number characters are used most often as character data. Punctuation characters are used as delimiters to separate different commands or pieces of data. Two special ASCII characters, carriage return (CR 0DH) and line feed (LF 0AH), are used to indicate the end of a message string.

**Table 4-1. Serial Interface Specifications**

Connector Type: 9-pin D-style plug
Connector Wiring: DTE
Voltage Levels: EIA RS-232C specified
Transmission Distance: 50 feet maximum
Timing Format: Asynchronous
Transmission Mode: Half duplex
Baud Rate: 9600
Handshake: Software timing
Character Bits: 1 start, 7 data, 1 parity, 1 stop
Parity: Odd
Terminators: CR(0DH) LF(0AH)
Command Rate: 20 commands per second maximum

### 4.1.4 Message Strings

A message string is a group of characters assembled to perform an interface function. There are three types of message strings commands, queries and responses. The computer issues command and query strings through user programs, the instrument issues responses. Two or more command or query strings can be chained together in one communication but they must be separated by a semi-colon (;). The total communication string must not exceed 64 characters in length.

*Message Strings (Continued)*

A command string is issued by the computer and instructs the instrument to perform a function or change a parameter setting. The format is <command mnemonic><space><parameter data><terminators>. Command mnemonics are listed in Paragraph 4.2. Parameters necessary for each one are described in Paragraph 4.2.1. Terminators must be sent with every message string.

A query string is issued by the computer and instructs the instrument to send a response. The query format is <query mnemonic><?><space><parameter data><terminators>. Query mnemonics are often the same as commands with the addition of a question mark. Parameter data is often unnecessary when sending queries. Query mnemonics are listed in Paragraph 4.2. Parameter data if necessary is described in Paragraph 4.2.1. Terminators must be sent with every message string. The computer should expect a response very soon after a query is sent.

A response string is the instruments response or answer to a query string. The response can be a reading value, status report or the present value of a parameter. Response data formats are listed along with the associated queries in Paragraph 4.2.1. The response is sent as soon as possible after the instrument receives the query. Typically it takes 10 ms for the instrument to begin the response. Some responses take longer.

#### **4.1.5 Message Flow Control**

It is important to remember that the user program is in charge of the serial communication at all times. The instrument cannot initiate communication, determine which device should be transmitting at a given time, or guarantee timing between messages. This is the responsibility of the user program.

When issuing commands only the user program should:

- Properly format and transmit the command including terminators as one string.
- Guarantee that no other communication is started for 50 ms after the last character is transmitted.
- Not initiate communication more than 20 times per second.

When issuing queries or queries and commands together the user program should:

- Properly format and transmit the query including terminators as one string.
- Prepare to receive a response immediately.
- Receive the entire response from the instrument including the terminators.
- Guarantee that no other communication is started during the response or for 50 ms after it completes.
- Not initiate communication more than 20 times per second.

*Message Flow Control (Continued)*

**NOTE:** The serial interface will not function during front panel setup operations. Do not use the front panel during serial communications.

Failure to follow these rules may result in inability to establish communication with the instrument or intermittent failures in communication.

**4.1.6 Serial Interface Basic Program**

A Visual BASIC program is included to illustrate the serial communication functions of the instrument. Refer to Paragraph 4.1.6.1 for instructions on how to set up the program. The Visual Basic code is provided in Table 4-3. While the hardware and software required to produce and implement this program is not included with the instrument, the concepts illustrated apply to almost any application where these tools are available.

**4.1.6.1 Visual Basic Serial Interface Program Setup**

The serial interface program (Table 4-3) works with Visual Basic 6.0 (VB6) on an IBM PC (or compatible) with a Pentium-class processor. A Pentium 90 or higher is recommended, running Windows 95 or better, with a serial interface. It uses the COM1 communications port at 9600 Baud. Use the following to develop the Serial Interface Program in Visual Basic.

1. Start VB6.
2. Choose Standard EXE and select Open.
3. Resize form window to desired size.
4. On the Project Menu, click Components to bring up a list of additional controls available in VB6.
5. Scroll through the controls and select Microsoft Comm Control 6.0. Select OK. In the toolbar at the left of the screen, the Comm Control will have appeared as a telephone icon.
6. Select the Comm control and add it to the form.
7. Add controls to form:
  - a. Add three Label controls to the form.
  - b. Add two TextBox controls to the form.
  - c. Add one CommandButton control to the form.
  - d. Add one Timer control to the form.
8. On the View Menu, select Properties Window.

*Visual Basic Serial Interface Program Setup (Continued)*

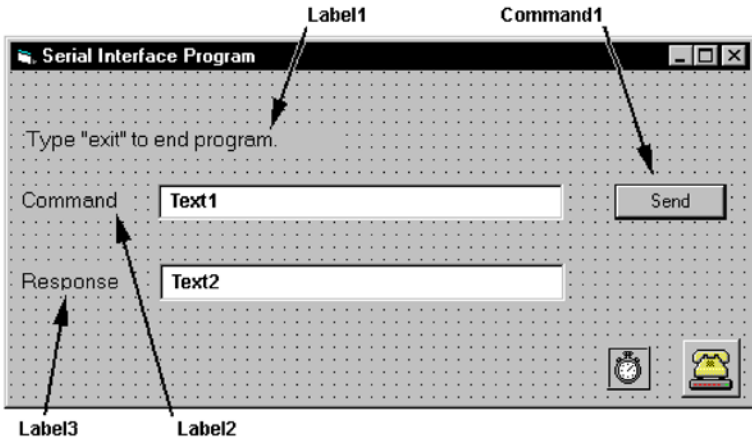

9. In the Properties window, use the dropdown list to select between the different controls of the current project.
10. Set the properties of the controls as defined in Table 4-2.
11. Save the program.

**Table 4-2. Serial Interface Program Control Properties**

Current Name	Property	New Value
Label1	Name Caption	lblExitProgram Type "exit" to end program.
Label2	Name Caption	lblCommand Command
Label3	Name Caption	lblResponse Response
Text1	Name Text	txtCommand <blank>
Text2	Name Text	txtResponse <blank>
Command1	Name Caption Default	cmdSend Send True
Form1	Name Caption	frmSerial Serial Interface Program
Timer1	Enabled Interval	False 10



*Visual Basic Serial Interface Program Setup (Continued)*

12. Add code (provided in Table 4-3).
  - a. In the Code Editor window, under the Object dropdown list, select (General). Add the statement: Public gSend as Boolean
  - b. Double Click on cmdSend. Add code segment under Private Sub cmdSend\_Click() as shown in Table 4-3.
  - c. In the Code Editor window, under the Object dropdown list, select Form. Make sure the Procedure dropdown list is set at Load. The Code window should have written the segment of code: Private Sub Form\_Load(). Add the code to this subroutine as shown in Table 4-3.
  - d. Double Click on the Timer control. Add code segment under Private Sub Timer1\_Timer() as shown in Table 4-3.
  - e. Make adjustments to code if different Com port settings are being used.
13. Save the program.
14. Run the program. The program should resemble the following.

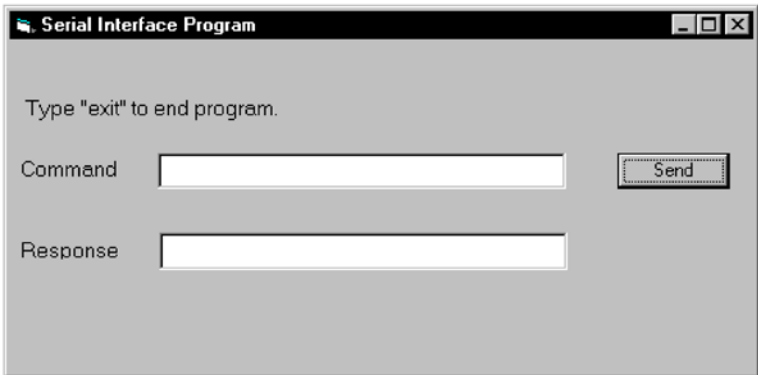

15. Type in a command or query in the Command box as described in Paragraph 4.1.6.2.
16. Press Enter or select the Send button with the mouse to send command.
17. Type Exit and press Enter to quit.

**Table 4-3. Visual Basic Serial Interface Program**

Public gSend As Boolean	'Global used for Send button state
Private Sub cmdSend_Click() gSend = True	'Routine to handle Send button press 'Set Flag to True
End Sub	
Private Sub Form_Load() Dim strReturn As String Dim strHold As String Dim Term As String Dim ZeroCount As Integer Dim strCommand As String	'Main code section 'Used to return response 'Temporary character space 'Terminators 'Counter used for Timing out 'Data string sent to instrument
frmSerial.Show	'Show main window
Term = Chr(13) & Chr(10)	'Terminators are <CR><LF>
ZeroCount = 0	'Initialize counter
strReturn = ""	'Clear return string
strHold = ""	'Clear holding string
If frmSerial.MSComm1.PortOpen = True Then frmSerial.MSComm1.PortOpen = False	'Close serial port to change settings
End If	
frmSerial.MSComm1.CommPort = 1	'Example of Comm 1
frmSerial.MSComm1.Settings = "9600,o,7,1"	'Baud,Parity,Data,Stop
frmSerial.MSComm1.InputLen = 1	'Read one character at a time
frmSerial.MSComm1.PortOpen = True	'Open port
Do	
Do	'Wait loop
DoEvents	'Give up processor to other events
Loop Until gSend = True	'Loop until Send button pressed
gSend = False	'Set Flag as false
strCommand = frmSerial.txtCommand.Text	'Get Command
strReturn = ""	'Clear response display
strCommand = UCase(strCommand)	'Set all characters to upper case
If strCommand = "EXIT" Then	'Get out on EXIT
End	
End If	

*Program continues on the next page...*

**Table 4-3. Visual Basic Serial Interface Program (Continued)**

frmSerial.MSComm1.Output = strCommand & Term	'Send command to instrument
If InStr(strCommand, "?") <> 0 Then	'Check to see if query
While (ZeroCount < 20) And (strHold <> Chr\$(10))	'Wait for response
If frmSerial.MSComm1.InBufferCount = 0 Then	'Add 1 to timeout if no character
frmSerial.Timer1.Enabled = True	
Do	
DoEvents	'Wait for 10 millisecond timer
Loop Until frmSerial.Timer1.Enabled = False	
ZeroCount = ZeroCount + 1	'Timeout at 2 seconds
Else	
ZeroCount = 0	'Reset timeout for each character
strHold = frmSerial.MSComm1.Input	'Read in one character
strReturn = strReturn + strHold	'Add next character to string
End If	
Wend	'Get characters until terminators
If strReturn <> "" Then	'Check if string empty
strReturn = Mid(strReturn, 1, InStr(strReturn, Term) - 1)	'Strip terminators
Else	
strReturn = "No Response"	'Send No Response
End If	
frmSerial.txtResponse.Text = strReturn	'Put response in textbox on main
form	
strHold = ""	'Reset holding string
ZeroCount = 0	'Reset timeout counter
End If	
Loop	
End Sub	
Private Sub Timer1_Timer()	'Routine to handle Timer interrupt
frmSerial.Timer1.Enabled = False	'Turn off timer
End Sub	

#### 4.1.6.2 Program Operation

Once the program is running, try the following commands and observe the response of the instrument. Input from the user is shown in **bold** and terminators are added by the program. The word [term] indicates the required terminators included with the response.

ENTER COMMAND? **\*IDN?** Identification query. Instrument will return a string identifying itself.

RESPONSE: LSCI,MODEL211,21A0000,022607[term]

ENTER COMMAND? **KRDG?** Kelvin reading query. Instrument will return a string with the present kelvin reading.

RESPONSE: +12.345[term]

ENTER COMMAND? **INTYPE 0** Input type command. Instrument will change the input type to silicon diode. No response will be sent.

ENTER COMMAND? **INTYPE?** Input type query. Instrument will return a string with the present input type setting.

RESPONSE: 0[term]

ENTER COMMAND? **INTYPE 0;INTYPE?** Input type command followed by input type query. Instrument will change the input type to silicon diode then return a string with the present input type setting.

RESPONSE: 0[term]

The following are additional notes on using the Serial Interface program.

- If you enter a correctly spelled query without a “?”, nothing will be returned. Incorrectly spelled commands and queries are ignored. Commands and queries should have a space separating the command and associated parameters.
- Leading zeros and zeros following a decimal point are not needed in a command string, but they will be sent in response to a query. A leading “+” is not required but a leading “-” is required.

#### 4.1.7 Trouble Shooting

##### *New Installation*

1. Make sure transmit (TD) signal line from the instrument is routed to receive (RD) on the computer and vice versa. (Use a null modem adapter if not).
2. Always send terminators
3. Send entire message string at one time including terminators. (Many terminal emulation programs do not.)

**Trouble Shooting (Continued)**

4. Send only one simple command at a time until communication is established.
5. Be sure to spell commands correctly and use proper syntax.

**Old Installation No Longer Working**

1. Power instrument off then on again to see if it is a soft failure.
2. Power computer off then on again to see if communication port is locked up.
3. Check all cable connections.

**Intermittent Lockups**

1. Check cable connections and length.
2. Increase delay between all commands to 100 ms to make sure instrument is not being overloaded.
3. Do not use the front panel keys during serial communication.

**4.2 SERIAL INTERFACE COMMAND SUMMARY**

This paragraph provides a summary of the Serial Interface Commands. The Interface Commands are detailed in Paragraph 4.2.1. A list of all commands is provided in Table 4-4.

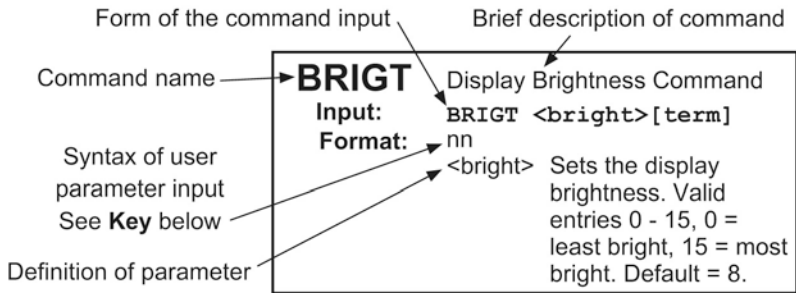

Commands may additionally include  
**Remarks and Examples.**

Command.jpg

*Serial Interface Command Summary (Continued)*

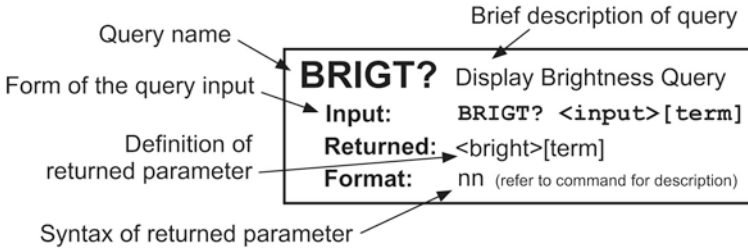

Query.jpg

**Key:**

- Q Begins common interface command.
- ? Required to identify queries.
- aa... String of alphanumeric characters.
- nn... String of number characters that may include a decimal point.
- [term] Terminator characters.
- <...> Indicated a parameter field, many are command specific.
- <state> Parameter field with only On/Off or Enable/Disable states.
- <value> Floating point values can have a varying resolution depending on the type of command or query issued.

**Table 4-4. Interface Commands (Alphabetical Listing)**

<u>Command</u>	<u>Function</u>	<u>Page</u>
QIDN?	Identification Query.....	14
QRST	Reset Instrument Command.....	14
ALARM	Input Alarm Parameter Command.....	14
ALARM?	Input Alarm Parameter Query.....	15
ALMRST	Alarm Reset Status Command.....	15
ANALOG	Analog Output Parameter Command.....	15
ANALOG?	Analog Output Parameter Query.....	15
AOUT?	Analog Output Data Query.....	15
BRIGT	Display Brightness Command.....	16
BRIGT?	Display Brightness Query.....	16
CRDG?	Celsius Reading Query.....	16
CRVDEL	Curve Delete Command.....	16
CRVHDR	Curve Header Command.....	16
CRVHDR?	Curve Header Query.....	17
CRVPT	Curve Data Point Command.....	17
CRVPT?	Curve Data Point Query.....	17
DFLT	Factory Defaults Command.....	18
DISPFLD	Displayed Field Command.....	18
DISPFLD?	Displayed Field Query.....	18
DISPON	Display ON/OFF Command.....	18
DISPON?	Display ON/OFF Query.....	18
FRDG?	Fahrenheit Reading Query.....	18
INCRV	Input Curve Number Command.....	19
INCRV?	Input Curve Number Query.....	19
INTYPE	Input Type Parameter Command.....	19
INTYPE?	Input Type Parameter Query.....	19
KEYST?	Keypad Status Query.....	19
KRDG?	Kelvin Reading Query.....	20
LOCK	Front Panel Keypad Lock Command.....	20
LOCK?	Front Panel Keypad Lock Query.....	20
RDGST?	Input Reading Status Query.....	20
RELAY	Relay Control Parameter Command.....	21
RELAY?	Relay Control Parameter Query.....	21
SRDG?	Sensor Units Input Reading Query.....	21

#### 4.2.1 Interface Commands (In Alphabetical Order)

---

<b>*IDN?</b>	Identification Query
<b>Input:</b>	<b>*IDN? [term]</b>
<b>Returned:</b>	<manufacturer>,<model>,<serial>,<date>[term]
<b>Format:</b>	aaaa,aaaaaaaa,aaaaaaaa,mmdyy <manufacture> Manufacturer ID <model> Instrument model number <serial> Serial number <date> Instrument firmware revision date
<b>Example:</b>	<b>LSCI,MODEL211,21A0000,022607</b>
<hr/>	
<b>*RST</b>	Reset Instrument Command
<b>Input:</b>	<b>*RST [term]</b>
<b>Remarks:</b>	Sets instrument parameters to power-up settings.
<hr/>	
<b>ALARM</b>	Input Alarm Parameter Command
<b>Input:</b>	<b>ALARM &lt;off/on&gt;, &lt;high value&gt;, &lt;low value&gt;, &lt;deadband&gt;,&lt;latch enable&gt;[term]</b>
<b>Format:</b>	n, +nnn.n, +nnn.n, +nn.n,n <off/on> Determines whether the instrument checks the alarm for input where 0 = off and 1 = on. <high value> Sets the value the temperature is checked against to activate the high alarm. <low value> Sets the value the temperature is checked against to activate low alarm. <deadband> Sets the value that the temperature must change outside of an alarm condition to deactivate an unlatched alarm. <latch enable> Specifies a latched alarm (remains active after alarm condition correction) where 0 = off (no latch) and 1 = on.
<b>Remarks:</b>	Configures the alarm parameters for the input.
<b>Example:</b>	<b>ALARM 1,270.0,0,0,1[term]</b> – Turns on alarm checking for the input, activates high alarm if kelvin reading is over 270, and latches the alarm when kelvin reading falls below 270.

---



---

**ALARM?** Input Alarm Parameter Query  
**Input:** **ALARM?** [ **term** ]  
**Returned:** <off/on>, <high value>, <low value>, <deadband>, <latch enable> [term]  
**Format:** n,+nnn.n,+nnn.n,+nn.n,n (Refer to command for description)

---

**ALMRST** Reset Alarm Status Command  
**Input:** **ALMRST** [ **term** ]  
**Remarks:** Clears both the high and low status of the alarm, including latching alarm.

---

**ANALOG** Analog Output Parameter Command  
**Input:** **ANALOG** <mode>, <range>[ **term** ]  
**Format:** n,n  
<mode> Specifies mode in which analog output operates where 0 = voltage mode and 1 = current mode.  
<range> Sets temperature range that analog output uses as full scale.  
0 = 0 – 20 K                      3 = 0 – 325 K  
1 = 0 – 100 K                     4 = 0 – 475 K  
2 = 0 – 200 K                    5 = 0 – 1000 K  
**Example:** **ANALOG 0,1[term]** – Sets analog output to voltage mode (0–10V) 100.0 K at +100% output (+10.0 V) and 0.0 K at 0% output (0.0 V).

---

**ANALOG?** Analog Output Parameter Query  
**Input:** **ANALOG?** [ **term** ]  
**Returned:** <mode>, <range> [term]  
**Format:** n,n (Refer to command for definition)

---

**AOUT?** Analog Output Data Query  
**Input:** **AOUT?** [ **term** ]  
**Returned:** <analog output>[term]  
**Format:** +nnn.nn  
**Remarks:** Returns the percentage of output of the analog output.

---

**BRIGT** Display Brightness Command  
**Input:** **BRIGT** <bright>[ term]  
**Format:** nn  
 <bright> Sets display brightness. Valid entries: 0–15,  
 0 = least bright, 15 = most bright. Default = 8.

---

**BRIGT?** Display Brightness Query  
**Input:** **BRIGT?** [ term]  
**Returned:** <bright>[term]  
**Format:** nn (Refer to command for description)

---

**CRDG?** Celsius Reading Query  
**Input:** **CRDG?** [ term]  
**Returned:** <temp value>[term]  
**Format:** ±nnnnnn  
**Remarks:** Also see the RDGST? command.

---

**CRVDEL** Curve Delete Command  
**Input:** **CRVDEL** <curve>[ term]  
**Format:** nn  
 <curve> Specifies user curve to delete. Only valid entry is  
 21. (Curve number is used to retain compatibility with  
 existing instrument line. Curve number 21 must be sent  
 with the command or else the command will be ignored.)

---

**CRVHDR** Curve Header Command  
**Input:** **CRVHDR** <curve>, <name>, <SN>, <format>,  
 <limit value>, <coefficient>[ term]  
**Format:** nn,aaaaaaaaaaaaaaaa,aaaaaaaaa,n,+nnn.nnn,n  
 <curve> Specifies user curve. Valid entry: 21.  
 <name> Curve name. Limited to 15 characters.  
 <SN> Curve serial number. Limited to 10 characters.  
 <format> Curve data format. Valid entries:  
 2 = V/K, 3 =  $\Omega$ /K, 4 = log  $\Omega$ /K.  
 <limit value>Curve temperature limit in kelvin (Unused).  
 <coefficient>Curves temperature coefficient.  
 Valid entries: 1 = negative, 2 = positive.  
**Remarks:** Configures the user curve header.

---

*Curve Header Command (Continued)*

**Example:** **CRVHDR 21,DT-470,00011134,2,325.0,1[term]** – Configures User Curve 21 with a name of DT-470, serial number of 00011134, data format of volts versus kelvin, upper temperature limit of 325 K, and negative coefficient.

---

**CRVHDR?** Curve Header Query

**Input:** **CRVHDR? <curve>[term]**

**Format:** nn  
<curve> Valid entries: 1–21.

**Returned:** <name>,<SN>,<format>,<limit value>,<coefficient>[term]

**Format:** aaaaaaaaaaaaaa,aaaaaaaaa,n,+nnn.nnn,n  
(Refer to command for description)

**Remarks:** Returns a standard or user curve header.

---

**CRVPT** Curve Data Point Command

**Input:** **CRVPT <curve>, <index>, <units value>, <temp value>[term]**

**Format:** nn,nnn,±nnnnnnn,+nnnnnnn  
<curve> Specifies which curve to configure. Valid entry: 21.  
<index> Specifies curve points index. Valid entries: 1–200.  
<units value> Specifies sensor units for point to 6 digits.  
<temp value> Specifies the corresponding temperature in kelvin for this point to 6 digits.

**Remarks:** Configures a user curve data point. To finalize curve entry, send the \*RST command or cycle the instrument power after all the curve points have been entered.

**Example:** **CRVPT 21,2,0.10191,470.000[term]** – Sets User Curve 21 second data point to 0.10191 sensor units and 470.000 K.

---

**CRVPT?** Curve Data Point Query

**Input:** **CRVPT? <curve>, <index>[term]**

**Format:** nn,nnn  
<curve> Specifies which curve to query: 1–21.  
<index> Specifies the points index in the curve: 1–200.

**Returned:** <units value>, <temp value>[term]

**Format:** ±nnnnnnn,+nnnnnnn (Refer to command for description)

**Remarks:** Returns a standard or user curve data point.

---

**DFLT** Factory Defaults Command  
**Input:** **DFLT 99 [term]**  
**Remarks:** Sets all configuration values to factory defaults and resets the instrument. The "99" is included to prevent accidentally setting the unit to defaults.

---

**DISPFLD** Displayed Field Command  
**Input:** **DISPFLD <source> [term]**  
**Format:** n  
 <source> Specifies input data to display. Valid entries:  
 0 = kelvin, 1 = Celsius, 2 = sensor units, 3 = Fahrenheit.  
**Example:** **DISPFLD 1 [term]** – Displays kelvin reading for the input.

---

**DISPFLD?** Displayed Field Query  
**Input:** **DISPFLD? [term]**  
**Returned:** <source>[term]  
**Format:** n (Refer to command for description)

---

**DISPON** Display On/Off Command  
**Input:** **DISPON <state> [term]**  
**Format:** n  
 <state> 0 = Off, 1 = On  
**Remarks:** Turns display On or Off. Display will default to On at power up or if any key is pressed (even if the keypad is locked).

---

**DISPON?** Display On/Off Query  
**Input:** **DISPON? [term]**  
**Returned:** <state> [term]  
**Format:** n (Refer to command for description)

---

**FRDG?** Fahrenheit Reading Query  
**Input:** **FRDG? [term]**  
**Returned:** <temp value>[term]  
**Format:** ±nnnnnn  
**Remarks:** Also see the RDGST? command.

---

---

**INCRV** Input Curve Number Command  
**Input:** **INCRV** <curve number> [term]  
**Format:** nn  
<curve number> Specifies which curve the input uses. If specified curve parameters do not match the input, the curve number defaults to 0. Valid entries: 0 = none, 1 – 20 = standard curves, 21 = user curve.  
**Remarks:** Specifies curve the input uses for temperature conversion.  
**Example:** **INCRV 21**[term] – The input User Curve 21 for temperature conversion.

---

**INCRV?** Input Curve Number Query  
**Input:** **INCRV?** [term]  
**Returned:** <curve number>[term]  
**Format:** nn (Refer to command for description)

---

**INTYPE** Input Type Parameter Command  
**Input:** **INTYPE** <sensor type> [term]  
**Format:** n  
<sensor type> Specifies input sensor type. Valid entries:  
0 = Silicon Diode                    3 = 100  $\Omega$  Platinum/500  
1 = GaAlAs Diode                    4 = 1000  $\Omega$  Platinum  
2 = 100  $\Omega$  Platinum/250        5 = NTC RTD  
**Example:** **INTYPE 0**[term] – Sets input sensor type to silicon diode.

---

**INTYPE?** Input Type Parameter Query  
**Input:** **INTYPE?** [term]  
**Returned:** <sensor type>[term]  
**Format:** n (Refer to command for description)

---

**KEYST?** Keypad Status Query  
**Input:** **KEYST?** [term]  
**Returned:** <keypad status>[term]  
**Format:** n            1 = key pressed, 0 = no key pressed.  
**Remarks:** Returns keypad status since the last KEYST?. KEYST? returns 1 after initial power-up.

---

**KRDG?** kelvin Reading Query  
**Input:** **KRDG?** [ **term** ]  
**Returned:** <kelvin value>[term]  
**Format:** +nnnnnn  
**Remarks:** Also see the RDGST? command.

---

**LOCK** Front Panel Keypad Lock Command  
**Input:** **LOCK** <state>[ **term** ]  
**Format:** n  
 <state> 0 = Unlocked, 1 = Locked  
**Remarks:** Locks out all front panel entries. Refer to Paragraph 3.10.  
**Example:** **LOCK 1**[term] – Enables keypad lock.

---

**LOCK?** Front Panel Keypad Lock Query  
**Input:** **LOCK?** [ **term** ]  
**Returned:** <state>[term]  
**Format:** n (Refer to command for description)

---

**RDGST?** Input Reading Status Query  
**Input:** **RDGST?** [ **term** ]  
**Returned:** <status bit weighting>[term]  
**Format:** nnn  
**Remarks:** Integer returned represents sum of bit weighting of the input status flag bits. "000" indicates a valid reading is present.

<i>Bit</i>	<i>Bit Weighting</i>	<i>Status Indicator</i>
1	2	A/D not responding
2	4	Alarm low
3	8	Alarm high
4	16	Temperature under range
5	32	Temperature over range
6	64	Sensor units zero
7	128	Sensor units over range

---

---

**RELAY** Relay Control Parameter Command

**Input:** **RELAY <relay number>, <mode>[term]**

**Format:** n,n  
<relay number> Specifies which relay to configure: 1 = low alarm relay, 2 = high alarm relay.  
<mode> Specifies relay mode. 0 = Off, 1 = On, 2 = Alarms.

**Example:** **RELAY 1,2[term]** – Low alarm relay activates when low alarm activates.

---

**RELAY?** Relay Control Parameter Query

**Input:** **RELAY? <relay number>[term]**

**Format:** n  
<relay number> Specifies which relay to query: 1 = low alarm relay, 2 = high alarm relay.

**Returned:** n (Refer to command for description)

---

**SRDG?** Sensor Units Input Reading Query

**Input:** **SRDG? [term]**

**Returned:** <sensor units value>[term]

**Format:** ±nnnnnn

**Remarks:** Also see the RDGST? command.

---

This Page Intentionally Left Blank



# CHAPTER 5

## SERVICE

### 5.0 GENERAL

This chapter provides basic service information for the Model 211 Temperature Monitor. Customer service of the product is limited to the information presented in this chapter. Factory trained service personnel should be consulted if the instrument requires repair.

### 5.1 CONTACTING LAKE SHORE

If a Lake Shore product was purchased through a dealer or representative, please use that resource for prompt sales or service information. When contacting Lake Shore directly, please specify the name of a department if you do not know the name of an individual. Questions regarding product applications, price, availability and shipments should be directed to sales. Questions regarding instrument calibration or repair should be directed to instrument service. **Do not return a product to Lake Shore without a Return Goods Authorization (RGA) number.** Refer to Paragraph 5.2. Contact information may change periodically but current contact information can always be found on the Lake Shore web site: [www.lakeshore.com](http://www.lakeshore.com).

When contacting Lake Shore please provide your name and complete contact information including e-mail address if possible. It is often helpful to include the instrument model number and serial number (located on the rear panel of the instrument) as well as the firmware revision information as described in Paragraph 3.12.

Mailing Address:	Lake Shore Cryotronics, Inc. Instrument Service Department 575 McCorkle Blvd. Westerville, OH USA 43082-8888	
E-mail Address:	sales@lakeshore.com service@lakeshore.com	Sales Instrument Service
Telephone:	614-891-2244 614-891-2243 ext. 131	Sales Instrument Service
Fax:	614-818-1600 614-818-1609	Sales Instrument Service

## 5.2 RETURNING PRODUCTS TO LAKE SHORE

If it is necessary to return the Model 211 or accessories for recalibration, repair or replacement, an RGA number must be obtained from a factory representative or from the Lake Shore web site. **Do not return a product to Lake Shore without an RGA number.** The following information must be provided to Lake Shore in order to obtain an RGA number.

1. Instrument model and serial number.
2. User name, company, address, phone number, and e-mail address.
3. Malfunction symptoms.
4. Description of the system in which the product is used.

If possible, the original packing material should be retained for reshipment. If not available, a minimum of three inches of shock adsorbent packing material should be placed snugly on all sides of the instrument in a sturdy corrugated cardboard box. Include the RGA number on the mailing label or written prominently on the outside of the box. Include a copy of the customer contact information and RGA number inside the box. Consult Lake Shore with questions regarding shipping and packing instructions.

## 5.3 ERROR MESSAGES

The following messages appear on the instrument display when it identifies a problem during operation. The messages are divided into two groups. Instrument hardware messages are related to the instruments internal circuits or non-volatile memory. If one of these messages persists after power is cycled the instrument requires repair or recalibration. Limit messages are most often associated with over voltage conditions caused by an improperly selected range or excessive noise on the measurement leads. If these messages persist after the input or output is configured properly, the instrument may require repair.

### 5.3.1 Instrument Hardware Errors

Err 01        Indicates that there is a hardware problem in the instrument memory. This error is not correctable by the user and the factory should be consulted.

Err 02        Indicates there is a soft error in the instrument memory. This error can be corrected reinitializing memory. Reinitializing memory sets the instrument to defaults and erases the user curve. To reinitialize the memory after an Error 02, press both the **s** and **t** keys simultaneously. The display will blank for about 5 seconds while the memory is initialized.

*Instrument Hardware Errors (Continued)*

- Err 03        Indicates the instrument has lost its calibration. To continue using the instrument in an uncalibrated state, press the Enter key after the Error 03 message appears. The Error 03 message is not cleared and will be displayed again on power up until the unit is calibrated.
- Err 04        Indicates that the A/D converter is not communicating with the microprocessor. This error is not correctable by the user. Please contact the factory for instrument return information.

**5.3.2    Limit Errors**

- Err 05        Input is at or under zero output.
- Err 06        Input is at or over full scale.
- Err 07        Temperature conversion is off the low end of the curve
- Err 08        Temperature conversion is off the high end of the curve
- Err 09        No curve is selected for the input.

**5.4    OPENING THE ENCLOSURE**

**WARNING:** To avoid potentially lethal shocks, disconnect the power cord from the instrument before performing this procedure. Only qualified personnel should perform this procedure.

***REMOVAL***

1. Disconnect the power cord from rear of unit.
2. If attached, remove from panel mount.
3. Use a Phillips screwdriver to remove the four flat-head screws from the corners of the rear panel.
4. Slide out the PC board assembly. The rear panel is attached to the PC board.

***INSTALLATION***

1. Slide the PC board assembly in from the rear of the chassis making sure the keypad aligns with the holes in the front panel.
2. Use a Phillips screwdriver to install four flat-head screws in the corners of the rear panel.
3. If required, replace the instrument in the panel mount opening.
4. Connect power cord to rear of the unit.

### 5.5 CONNECTOR DEFINITIONS

The POWER, INPUT/OUTPUT, and RS-232 (DTE) connectors are defined in Figures 5-1 through 5-3.

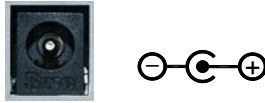

**Connector Accepts a Barrel Plug 5.5mm OD x 2.1mm ID x 9.9 mm L.**

**Figure 5-1. Power Connector**

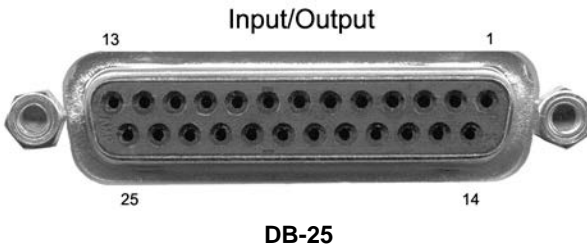

P-211-2-3.bmp

Pin	Description	Pin	Description
1	No Connection	—	—
2	Shield	14	Shield
3	I+	15	I-
4	V+	16	V-
5	Shield	17	Shield
6	Analog Output Signal	18	Analog Output Ground
7	No Connection	19	No Connection
8	Low Alarm COM	20	Low Alarm NO
9	Low Alarm NC	21	No Connection
10	No Connection	22	No Connection
11	High Alarm COM	23	High Alarm NO
12	High Alarm NC	24	No Connection
13	No Connection	25	No Connection

**Figure 5-2. Input/Output Connector**

*Connector Definitions (Continued)*



Serial Connector.bmp

Model 211 Temperature Monitor		Typical Computers			
DE-9P (DTE)		DB-25P (DTE)		DE-9P (DTE)	
Pin	Description	Pin	Description	Pin	Description
1	No Connection	2	TD (out)	1	DCD (in)
2	Receive Data (RD in)	3	RD (in)	2	RD (in)
3	Transmit Data (TD out)	4	RTS (out)	3	TD (out)
4	Data Terminal Ready (DTR out)	5	CTS (in)	4	DTR (out)
5	Ground (GND)	6	DSR (in)	5	GND
6	No Connection	7	GND	6	DSR (in)
7	Data Terminal Ready (DTR out) (tied to 4)	8	DCD (in)	7	RTS (out)
8	No Connection	20	DTR (out)	8	CTS (in)
9	No Connection	22	Ring in (in)	9	Ring in (in)

**Figure 5-3. RS-232 (DTE) Connector**

### 5.5.1 Serial Interface Cable Wiring

The following are suggested cable wiring diagrams for connecting the Model 211 serial interface to various customer personal computers (PCs).

#### Model 211 to PC Serial Interface – PC with DE-9P

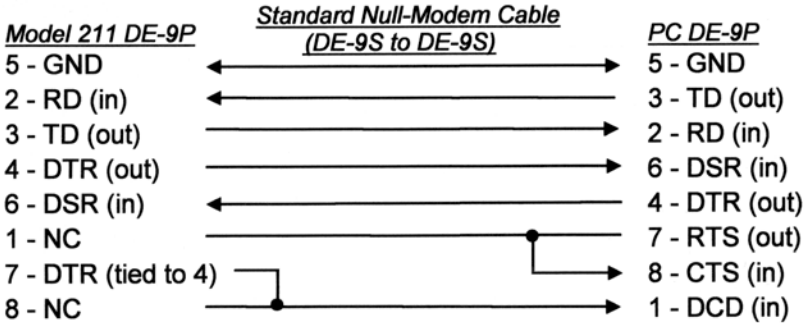

#### Model 211 to PC Serial Interface – PC with DB-25P

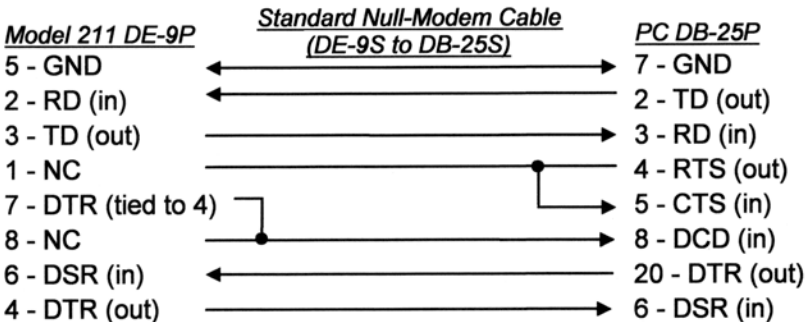

#### Model 211 to PC Interface using Null Modem Adapter

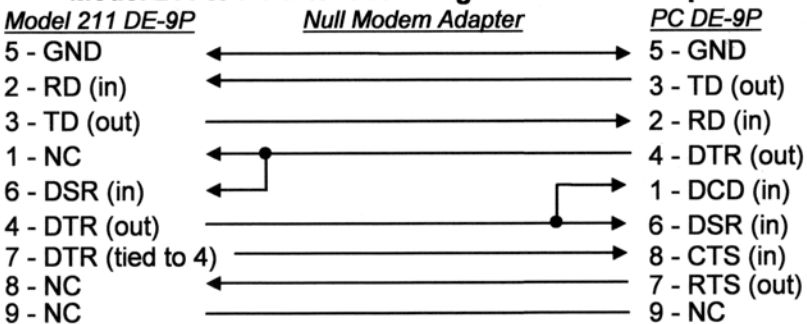

**NOTE:** Same as null modem cable design except PC CTS is provided from the Model 211 on DTR.

## 5.6 CALIBRATION PROCEDURE

The Model 211 requires calibration of both the sensor input and analog output to operate within the specification published in Paragraph 1.2 of this manual. None of the other circuits require calibration. Refer to Paragraph 5.6.4 for details on calibration specific interface commands.

**WARNING:** Only qualified personnel should perform this procedure.

### 5.6.1 Equipment Required for Calibration

#### *PC and Interface*

- PC with software loaded providing serial command line communication; example program in Paragraph 4.1.6 is ideal for this purpose
- Serial interface cable

#### *Test and Measurement Equipment*

- Digital Multimeter (DMM) with minimum of 6 digits resolution; DMM DC voltage and 4-lead resistance specifications to be equivalent to or better than Agilent 34401 specifications
- Cable to attach resistor standards to input

#### *Resistor Standards*

- Resistor standards with the following nominal values (if standards are not available, 0.25 W, 25 ppm/°C metal film resistors can be used); resistors should have connectors for 4-lead measurement
- 0  $\Omega$  (short), 100  $\Omega$ , 250  $\Omega$ , 500  $\Omega$ , 2.5 k $\Omega$ , 5 k $\Omega$ , 7.5 k $\Omega$ , 100 k $\Omega$ , 250 k $\Omega$

### 5.6.2 Diode/Resistor Sensor Input Calibration

The sensor input contains a current source that can supply 10  $\mu\text{A}$  or 1 mA of current, but only the 10  $\mu\text{A}$  current source is adjusted during calibration. It is calibrated by adjusting the pot on the Model 211 main board. The sensor input contains multiple gain stages to accommodate the various sensors the Model 211 supports. The input gain and 1 mA circuitry are not adjusted during calibration. Instead, calibrated resistors are attached to the input and mathematical calibration constants are calculated and programmed into the 211 to compensate for input offset and gain errors.

#### 5.6.2.1 *Sensor Input Calibration Setup and Serial Communication Verification*

1. Allow the 211 to warm up for at least 1 hour with the input configured for Silicon diode and a 250 k $\Omega$  resistor standard attached to the input.
2. Connect the 211 to the PC via the serial port.
3. Verify operation of serial communication by sending the \*IDN? command and receiving the proper response from the 211.

### **5.6.2.2 10 $\mu$ A Current Source Calibration and 1 mA Current Source Verification**

#### ***Purpose***

To calibrate the 10  $\mu$ A current source to be within the specified tolerance and verify operation of the 1 mA current source.

#### ***Process***

1. Configure the input for the silicon diode input type.
2. Accurately determine the value of the 250 k $\Omega$  resistor using the DMM. Determine the calibration value by multiplying the actual resistance of the 250 k $\Omega$  resistor by  $10 \times 10^{-6}$ .
3. Attach the 250 k $\Omega$  resistor to the 211 input using proper 4-lead connection techniques, configure the DMM to read VDC and attach across the voltage terminals of the resistor.
4. Remove the four screws on the rear panel of the instrument. Slide the PC board assembly out enough to expose R9.
5. Adjust the current source calibration pot, R9, on the 211 main board until the DMM reads the value calculated in Step 2 to  $\pm 0.0002$  VDC.
6. Slide the PC board back into the enclosure and replace the four screws on the rear panel.
7. Configure the input for the 1 k $\Omega$  platinum input type.
8. Accurately determine the value of the 1 k $\Omega$  resistor using the DMM. Determine the verification value by multiplying the actual resistance of the 1 k $\Omega$  resistor by  $1 \times 10^{-3}$ .
9. Attach the 1 k $\Omega$  resistor to the 211 input using proper 4-lead connection techniques, configure the DMM to read VDC and attach to the resistor.
10. Measure voltage across resistor and verify it is within  $\pm 0.3\%$  of the value calculated in Step 8.

### **5.6.2.3 Input Gain Calibration**

#### ***Purpose***

To determine the input offset and gain errors when the input is configured for each of the input types and provide offset and gain calibration constants back to the 211. Refer to CALZ and CALG commands in Paragraph 5.6.4.

#### ***Process***

1. Configure the input for the type to be calibrated.



*Input Gain Calibration (Continued)*

- Reset the calibration constants to their default values using the **CALZ** and **CALG** commands.

**Example:**

Input Type: GaAlAs Diode  
 Zero Offset Reset Command: **CALZ 1,1,0**  
 Gain Reset Command: **CALG 1,1,1**

- Attach the 0  $\Omega$  (short) resistor standard to the input.
- Via the interface obtain the input reading using the **CALREAD?** command and record this number.
- Program the offset calibration by providing the inverse of the value read in the previous step using the **CALZ** command.

**Example:**

Input Type: GaAlAs Diode  
**CALREAD?** Reading: 0.00005  
 Calibration Command: **CALZ 1,1,-0.00005**

- Select resistor standard for the range being calibrated from Table 5-1 and accurately determine value of the resistor to the tolerance shown.
- Attach the resistor standard to the 211 sensor input. Be sure to connect the resistor using proper 4-lead connection techniques.
- Via the interface obtain the input reading using the **CALREAD?** command and record this number.
- Program the gain calibration by dividing the actual resistance of the calibration resistor by the value read in the previous step and provide the result using the **CALG** command. Note that the gain calibration constant will always be within 5% of 1.00000.

**Table 5-1. Calibration Table for Resistive Ranges**

Input Type	Calibration Resistor Nominal Value	Resistor Value Tolerance	Calibration Command Type Number
Silicon Diode	250 k $\Omega$	$\pm 20.5 \Omega$	0
GaAlAs Diode	250 k $\Omega$	$\pm 20.5 \Omega$	1
Platinum 250 $\Omega$	250 $\Omega$	$\pm 0.027 \Omega$	2
Platinum 500 $\Omega$	500 $\Omega$	$\pm 0.052 \Omega$	3
Platinum 1000 $\Omega$	5 k $\Omega$	$\pm 1.03 \Omega$	4
NTC RTD	7.5 k $\Omega$	$\pm 1.55 \Omega$	5

*Input Gain Calibration (Continued)*

**Example:**

Input Type: 100  $\Omega$  platinum/250

Measured Value of Calibration Resistor: 250.025  $\Omega$

**CALREAD?** Reading: 250.145

Constant Calculation:  $250.025 / 250.145 = 0.99952$

Calibration Command: **CALG 1,2,0.99952**

10. Repeat for all input ranges.
11. Send the **CALSAVE** command to finalize the calibration.

### **5.6.3 Analog Output Calibration and Verification**

The 211 has one analog output which requires calibration. Both the voltage and current modes of the output need to be calibrated separately. Zero offset and gain errors are calibrated out by programming offset and gain constants to the instrument. Reference the CALZ and CALG commands and the extended version of the ANALOG command in Paragraph 5.6.4.

#### **5.6.3.1 Analog Output Voltage Mode Calibration**

**Purpose**

To determine the analog output voltage mode offset and gain errors and provide offset and gain calibration constants back to the 211.

**Process**

1. Reset the calibration constants to their default values using the **CALZ** and **CALG** commands.

**Example:**

Zero Offset Reset Command: **CALZ 2,0,0**

Gain Reset Command: **CALG 2,0,1**

2. Connect the 100 k $\Omega$  resistor standard to the analog output using only the two voltage leads. Connect the positive lead of the DMM to the analog output positive terminal, the negative lead is connected to the analog output negative terminal.
3. Set the analog output to manual mode, manual output of 0%.

**Example:**

Manual Zero Voltage Command: **ANALOG 4,0**

4. Read the output voltage with the DMM and record this zero output (ZERO) value.
5. Set the analog output to +100%.

**Example:**

Manual + FS Voltage Command: **ANALOG 4,2**

6. Read the output voltage with the DMM and record this positive full scale (+FS) value.

*Analog Output Voltage Mode Calibration (Continued)*

7. Determine the offset calibration constant by dividing the ZERO value by the difference of the +FS value and the ZERO value and then inverting the result. Offset constant =  $-[\text{ZERO} / (+\text{FS} - \text{ZERO})]$ .
8. Use the **CALZ** command to send the offset calibration constant.

**Example:**

ZERO DMM Reading: -0.05632

+FS DMM Reading: 10.0135

Offset Constant Calculation:

$$-(-0.05632 / (10.0135 - (-0.05632))) = 0.00559$$

Calibration Command: **CALZ 2,0,0.00559**

9. Determine the gain calibration constant by adding the +FS reading to the inverse of the ZERO reading obtained in step 3 and dividing that number into 10. Gain constant =  $10 / (+\text{FS} - \text{ZERO})$ .
10. Use the **CALG** command to send the gain calibration constant.

**Example:**

ZERO DMM Reading: -0.05632

+FS DMM Reading: 10.0135

Gain Constant Calculation:  $10 / (10.0135 - (-0.05632)) = 0.99307$

Calibration Command: **CALG 2,0,0.99307**

**5.6.3.2 Analog Output Current Mode Calibration**

**Purpose**

To determine the analog output current mode offset and gain errors and provide offset and gain calibration constants back to the 211.

**Process**

1. Reset the calibration constants to their default values using the CALZ and CALG commands.

**Example:**

Zero Offset Reset Command: **CALZ 2,1,0**

Gain Reset Command: **CALG 2,1,1**

2. Accurately determine the value of the 250  $\square\Omega$  resistor using the DMM.
3. Connect the 250  $\square\Omega$  resistor standard to the analog output with the two current leads. Connect the DMM to the two voltage leads of the resistor standard.
4. Set the analog output to manual mode, manual output of 0% (4 mA).

**Example:**

Manual Zero Current Command: **ANALOG 3,0**

*Analog Output Current Mode Calibration (Continued)*

5. Read the output voltage with the DMM. Divide this number by the measured resistor value and record this zero output (ZERO) value.
6. Set the analog output to +100% (20 mA).

**Example:**

Manual +FS Current Command: **ANALOG 3,2**

7. Read the output voltage with the DMM. Divide this number by the measured resistor value and record this positive full scale (+FS) value.
8. Determine the offset calibration constant by subtracting the ZERO value from the zero current point of 4 mA and divide that by the difference of the +FS value and the ZERO value.  
Offset constant =  $(4E-3 - ZERO) / (+FS - ZERO)$ .
9. Use the **CALZ** command to send the offset calibration constant.

**Example:**

ZERO DMM Reading: 4.03974E-3

+FS DMM Reading: 20.0674E-3

Offset Constant Calculation:  $(4E-3 - 4.03974E-3) /$   
 $(20.0674E-3 - 4.03974E-3) = -0.00248$

Calibration Command: **CALZ 2,1,-0.00248**

10. Determine the gain calibration constant by adding the +FS reading to the inverse of the ZERO reading obtained in step 5 and dividing that number into 16 mA. Gain constant =  $16E-3 / (+FS - ZERO)$ .
11. Use the **CALG** command to send the gain calibration constant.

**Example:**

ZERO DMM Reading: 4.03974E-3

+FS DMM Reading: 20.0674E-3

Gain Constant Calculation:

$16E-3 / (20.0674E-3 - 4.03974E-3) = 0.99827$

Calibration Command: **CALG 2,1,0.99827**

12. Send the **CALSAVE** command to finalize the calibration.

### 5.6.4 Calibration Specific Interface Commands

---

**ANALOG** Analog Output Parameter Command

**Input:** **ANALOG** <mode>, <range>[term]

**Format:** n,n

<mode> Specifies analog output voltage mode, current mode, voltage calibration mode, or current calibration mode.

0 = Voltage mode

1 = Current mode

3 = Current calibration mode

4 = Voltage calibration mode

<range> Specifies analog output range. Valid entries are:

0 = 0 – 20 K or 0% output calibration mode

1 = 0 – 100 K or 50% output calibration mode

2 = 0 – 200 K or 100% output calibration mode

3 = 0 – 325 K

4 = 0 – 475 K

5 = 0 – 1000 K

**Remarks:** Allows manual setting of analog output values for calibration purposes.

---

**ANALOG?** Analog Output Parameter Query

**Input:** **ANALOG?** [term]

**Returned:** <mode>, <range>[term]

**Format:** n,n (Refer to command for description)

---

**CALG** Gain Calibration Constant Command

**Input:** **CALG** <input>, <type>, <value>[term]

**Format:** n,n,+n.nnnnn

<input> Specifies input or analog output the gain calibration constant will be provided to. Valid entries are 1 for input and 2 for the analog output.

<type> Specifies the input sensor type. Valid entries are:  
 0 = Silicon Diode or Analog Output Voltage Mode  
 1 = GaAlAs Diode or Analog Output Current Mode  
 2 = 100Ω Plat/250  
 3 = 100Ω Plat/500  
 4 = 1000Ω Plat  
 5 = NTC RTD

<value> Gain calibration constant value.

**Remarks:** Provides the gain calibration constant for the selected input or analog output.

---

**CALG?** Gain Calibration Constant Query

**Input:** **CALG?** <input>, <type>[term]

**Returned:** <mode>, <range>[term]

**Format:** n,n

<input> 1, or 2

<type> 0 – 5

**Returned:** <value>[term]

**Format:** +n.nnnnn (Refer to command for description.)

---

**CALREAD?** 6-Digit Input Reading Query

**Input:** **CALREAD?** [term]

**Returned:** <value>[term]

**Format:** ±nnnnnnn

**Remarks:** Returns 6-digit value of selected input reading. Used for CALZ and CALG functions.

---

**CALSAVE** Calibration Save Command

**Input:** **CALSAVE** [term]

**Remarks:** Finalizes the calibration procedure. This command calculates and stores a checksum of the calibration memory. This checksum is used on power up to determine if the instrument is calibrated properly. If this command is not sent after a calibration, the instrument will display an "Err 03" on power up. Refer to Paragraph 5.3.1.

---

**CALZ** Zero Offset Calibration Constant Command

**Input:** **CALZ** <input>, <type>, <value> [term]

**Format:** n,n,±nnnnnnn

<input> Specifies the input or analog output the zero offset calibration constant will be provided to. Valid entries are 1 for input and 2 for the analog output.

<type> Specifies the input sensor type. Valid entries are:  
 0 = Silicon Diode or Analog Out Voltage Mode  
 1 = GaAlAs Diode or Analog Out Current Mode  
 2 = 100 Ω Plat/250  
 3 = 100 Ω Plat/500  
 4 = 1000 Ω Plat  
 5 = NTC RTD

<value> Zero offset calibration constant value.

**Remarks:** Provides the zero offset calibration constant for the input or analog output.

---

**CALZ?** Zero Offset Calibration Constant Query

**Input:** **CALZ?** <input>, <type> [term]

**Format:** n,n

<input> 1, or 2

<type> 0 – 5

**Returned:** <value> [term]

**Format:** ±nnnnnnn (Refer to command for description)

---

This Page Intentionally Left Blank



## CHAPTER 6

### OPTIONS AND ACCESSORIES

#### 6.0 GENERAL

This chapter provides lists of models, options, accessories, sensors, wires, and special equipment available for the Model 211.

#### 6.1 MODELS

Part #	Description
211S	Model 211 temperature monitor, single channel
211N	Model 211S with no power supply

#### 6.2 ACCESSORIES

Part #	Description
109-132*	100-240 V, 6 W power supply (universal input, changeable input plugs)
G-106-253*	Sensor input mating connector (DB-25)
G-106-264*	Shell for sensor input mating connector
0-204*	Cable clamp
G-110-110*	Rubber feet
2111	Panel mount adapter for one Model 211 into 105 mm wide × 132 mm high (4.1 × 5.2 in) mounting plate. See Fig. 2-5.
2112	Panel mount adapter for two Model 211s into 105 mm wide × 132 mm high (4.1 × 5.2 in) mounting plate. See Fig. 2-5.
8000	CalCurve™, floppy disk. Consists of a calibrated sensor breakpoint table on a floppy disk in ASCII format for customer download
8001-211	CalCurve™, factory installed. Consists of a calibrated sensor breakpoint table factory-installed into nonvolatile memory
—	Calibration certificate*
CAL-211-CERT	Instrument recalibration with certificate
CAL-211-DATA	Instrument recalibration with certificate and data
MAN-211*	User's manual

\* Included with Model 211S.

### 6.3 WIRES

Common cryogenic wire available from Lake Shore. Other wire and installation accessories are also available.

P/N	Cable Description
<b>9001-005</b>	<b>Quad-Twist™ Cryogenic Wire.</b> Two twisted pairs, phosphor-bronze wire, 36 AWG, 0.127 mm (0.005 in) diameter.
<b>9001-006</b>	<b>Duo-Twist™ Cryogenic Wire.</b> Single twisted pair, phosphor-bronze wire, 36 AWG, 0.127 mm (0.005 in) diameter.
<b>9001-007</b>	<b>Quad-Lead™ Cryogenic Wire.</b> Phosphor-bronze wire, flat, 32 AWG, 0.203 mm (0.008 in) diameter.
<b>9001-008</b>	<b>Quad-Lead™ Cryogenic Wire.</b> Phosphor-bronze wire, flat, 36 AWG, 0.127 mm (0.005 in) diameter.

### 6.4 SENSORS

Silicon diode sensors available from Lake Shore. Other sensors are also available.

Sensor No.	Sensor Description
<b>Series DT-420</b>	The smallest silicon diode Temperature Sensor available. For installation on flat surfaces. Sensor incorporates the same type of silicon chip used in the Series DT-470 and DT-471.
<b>Series DT-450</b>	Silicon Diode Miniature Temperature Sensor. Same silicon chip used in the DT-470 configured for installation in recesses as small as 1.6 mm diameter by 3.2 mm deep.
<b>Series DT-470</b>	Silicon Diode Temperature Sensor. Interchangeable, repeatable, accurate, wide range customized for cryogenics.
<b>Series DT-471</b>	An economical version of the DT-470 for applications where temperature measurements below 10 K are not required.
<b>Series DT-670</b>	Lake Shore DT-670 diode temperature sensors offer the best accuracy across the widest useful temperature range – 1.4 to 500 K – of any silicon diode sensor in the industry. Sensors within the DT-670 series are interchangeable to the Curve DT-670.

# APPENDIX A

## CURVE TABLES

### A1.0 GENERAL

The following curve tables are applicable to the Model 211 temperature monitor.

- Curve 1     DT-470 Silicon Diode..... Table A-1
- Curve 2     DT-670 Silicon Diode..... Table A-2
- Curve 3     CTI Curve C Silicon Diode..... Table A-3
- Curve 6     PT-100 Platinum RTD ..... Table A-4
- Curve 7     PT-1000 Platinum RTD ..... Table A-4

**Table A-1. Lake Shore DT-470 Silicon Diode (Curve 10)**

Break-point	Temp. (K)	Volts	Break-point	Temp. (K)	Volts	Break-point	Temp. (K)	Volts
1	475.0	0.09062	30	170.0	0.82405	59	031.0	1.10476
2	470.0	0.10191	31	160.0	0.84651	60	030.0	1.10702
3	465.0	0.11356	32	150.0	0.86874	61	029.0	1.10945
4	460.0	0.12547	33	145.0	0.87976	62	028.0	1.11212
5	455.0	0.13759	34	140.0	0.89072	63	027.0	1.11517
6	450.0	0.14985	35	135.0	0.90161	64	026.0	1.11896
7	445.0	0.16221	36	130.0	0.91243	65	025.0	1.12463
8	440.0	0.17464	37	125.0	0.92317	66	024.0	1.13598
9	435.0	0.18710	38	120.0	0.93383	67	023.0	1.15558
10	430.0	0.19961	39	115.0	0.94440	68	022.0	1.17705
11	420.0	0.22463	40	110.0	0.95487	69	021.0	1.19645
12	410.0	0.24964	41	105.0	0.96524	70	019.5	1.22321
13	400.0	0.27456	42	100.0	0.97550	71	017.0	1.26685
14	395.0	0.28701	43	095.0	0.98564	72	015.0	1.30404
15	380.0	0.32417	44	090.0	0.99565	73	013.5	1.33438
16	365.0	0.36111	45	085.0	1.00552	74	012.5	1.35642
17	345.0	0.41005	46	080.0	1.01525	75	011.5	1.38012
18	330.0	0.44647	47	075.0	1.02482	76	010.5	1.40605
19	325.0	0.45860	48	070.0	1.03425	77	009.5	1.43474
20	305.0	0.50691	49	065.0	1.04353	78	008.5	1.46684
21	300.0	0.51892	50	058.0	1.05630	79	007.5	1.50258
22	285.0	0.55494	51	052.0	1.06702	80	005.2	1.59075
23	265.0	0.60275	52	046.0	1.07750	81	004.2	1.62622
24	250.0	0.63842	53	040.0	1.08781	82	003.4	1.65156
25	235.0	0.67389	54	039.0	1.08953	83	002.6	1.67398
26	220.0	0.70909	55	036.0	1.09489	84	002.1	1.68585
27	205.0	0.74400	56	034.0	1.09864	85	001.7	1.69367
28	190.0	0.77857	57	033.0	1.10060	86	001.4	1.69818
29	180.0	0.80139	58	032.0	1.10263			

**Table A-2. Lake Shore DT-670 Silicon Diode**

Break-point	Temp. (K)	Volts	Break-point	Temp. (K)	Volts	Break-point	Temp. (K)	Volts
1	500.0	0.090570	26	87.0	1.01064	51	20.2	1.19475
2	491.0	0.110239	27	81.0	1.02125	52	17.10	1.24208
3	479.5	0.136555	28	75.0	1.03167	53	15.90	1.26122
4	461.5	0.179181	29	69.0	1.04189	54	14.90	1.27811
5	425.5	0.265393	30	63.0	1.05192	55	14.00	1.29430
6	390.0	0.349522	31	56.4	1.06277	56	13.15	1.31070
7	346.0	0.452797	32	49.0	1.07472	57	12.35	1.32727
8	320.0	0.513393	33	38.7	1.09110	58	11.55	1.34506
9	298.5	0.563128	34	35.7	1.09602	59	10.75	1.36423
10	279.0	0.607845	35	33.3	1.10014	60	10.00	1.38361
11	261.0	0.648723	36	31.2	1.10393	61	9.25	1.40454
12	244.0	0.686936	37	29.6	1.10702	62	8.50	1.42732
13	228.0	0.722511	38	28.3	1.10974	63	7.75	1.45206
14	213.0	0.755487	39	27.3	1.11204	64	6.80	1.48578
15	198.5	0.786992	40	26.5	1.11414	65	5.46	1.53523
16	184.5	0.817025	41	25.8	1.11628	66	4.56	1.56684
17	171.5	0.844538	42	25.2	1.11853	67	4.04	1.58358
18	159.5	0.869583	43	24.7	1.12090	68	3.58	1.59690
19	148.0	0.893230	44	24.3	1.12340	69	3.18	1.60756
20	137.5	0.914469	45	24.0	1.12589	70	2.62	1.62125
21	127.5	0.934356	46	23.7	1.12913	71	2.26	1.62945
22	118.0	0.952903	47	23.3	1.13494	72	1.98	1.63516
23	109.0	0.970134	48	22.8	1.14495	73	1.74	1.63943
24	100.5	0.986073	49	22.0	1.16297	74	1.53	1.64261
25	93.5	0.998925	50	21.3	1.17651	75	1.40	1.64430

**Table A-3. CTI Curve C Silicon Diode**

<b>Breakpoint</b>	<b>Temp. (K)</b>	<b>Volts</b>
1	320.0	0.2968
2	305.0	0.3382
3	295.0	0.3640
4	285.0	0.3911
5	280.0	0.4050
6	270.0	0.4341
7	250.0	0.4896
8	195.0	0.6408
9	165.0	0.7255
10	140.0	0.7971
11	130.0	0.8245
12	125.0	0.8376
13	115.0	0.8625
14	110.0	0.8769
15	100.0	0.9049
16	95.0	0.9184
17	90.0	0.9314
18	85.0	0.9440
19	77.4	0.9626
20	65.0	0.9958
21	60.0	1.0100
22	36.0	1.0747
23	20.0	1.1162
24	19.0	1.1290
25	18.0	1.1500
26	14.0	1.3161
27	12.0	1.3656
28	11.0	1.3850
29	10.0	1.4000

**Table A-4. Lake Shore PT-100/-1000 Platinum RTD Curves**

Break-point	PT-100		PT-1000	
	Temp. (K)	Ohms ( $\Omega$ )	Temp. (K)	Ohms ( $\Omega$ )
1	030.0	3.820	030.0	38.20
2	032.0	4.235	032.0	42.35
3	036.0	5.146	036.0	51.46
4	038.0	5.650	038.0	56.50
5	040.0	6.170	040.0	61.70
6	042.0	6.726	042.0	67.26
7	046.0	7.909	046.0	79.09
8	052.0	9.924	052.0	99.24
9	058.0	12.180	058.0	121.80
10	065.0	15.015	065.0	150.15
11	075.0	19.223	075.0	192.23
12	085.0	23.525	085.0	235.25
13	105.0	32.081	105.0	320.81
14	140.0	46.648	140.0	466.48
15	180.0	62.980	180.0	629.80
16	210.0	75.044	210.0	750.44
17	270.0	98.784	270.0	987.84
18	315.0	116.270	315.0	1162.70
19	355.0	131.616	355.0	1316.16
20	400.0	148.652	400.0	1486.52
21	445.0	165.466	445.0	1654.66
22	490.0	182.035	490.0	1820.35
23	535.0	198.386	535.0	1983.86
24	585.0	216.256	585.0	2162.56
25	630.0	232.106	630.0	2321.06
26	675.0	247.712	675.0	2477.12
27	715.0	261.391	715.0	2613.91
28	760.0	276.566	760.0	2765.66
29	800.0	289.830	800.0	2898.30

## **APPENDIX B**

### **REGULATORY DECLARATIONS**

#### **B1.0 GENERAL**

Declarations in this appendix apply to the Lake Shore Cryotronics Model 211 Temperature Controller beginning with serial number 21A0000 and subsequent as well as its power supply. Paragraphs B1.1 and B1.2 refer to the CE and RoHS declarations respectively for the Model 211 alone. Paragraphs B1.3 and B1.6 refer to the CE and RoHS declarations respectively for the unit's power supply.

The declarations included are as follows:

- CE declaration for the Model 211

- CE declaration for the power supply, P/N 109-132

- CE and RoHS declarations for discontinued power supplies

## B1.1 MODEL 211 CE DECLARATION OF CONFORMITY



### EU DECLARATION OF CONFORMITY



This declaration of conformity is issued under the sole responsibility of the manufacturer.

**Manufacturer:**

Lake Shore Cryotronics, Inc.  
575 McCorkle Boulevard  
Westerville, OH 43082  
USA

**Object of the declaration:**

**Model(s):** 211A  
**Description:** Cryogenic Temperature Monitor

**The object of the declaration described above is in conformity with the relevant Union harmonization legislation:**

2014/30/EU EMC Directive  
2011/65/EU RoHS

**References to the relevant harmonized standards used to the specification in relation to which conformity is declared:**

EN 61326-1:2013  
Class B  
Controlled Electromagnetic Environment

EN 50581:2012

**Signed for and on behalf of:**

**Place, Date:**  
Westerville, OH, USA  
29-SEP-2016

  
\_\_\_\_\_  
Scott Ayer  
Director of Quality & Compliance



**B1.2 POWER SUPPLY CE DECLARATION, PART NUMBER 109-132**



**EC – Declaration of Conformity**

For the following equipment:

Switching Power Supply

**Series Number: SMI6**

Imported By:

**CUI Inc**

**20050 SW 112<sup>th</sup> Ave**

**Tualatin, OR 97062**

Is herewith confirmed to comply with the requirements set out in the Council Directive on the Approximation of the Laws of Member States relating to the Electromagnetic Compatibility Directive 2014/30/EU, Low Voltage Directive 2014/35/EU, RoHS Directive 2011/65/EU, and WEEE Directive 2012/19/EU. For the evaluation regarding the Electromagnetic Compatibility 2014/30/EU, Low Voltage Directive 2014/35/EU, RoHS Directive 2011/65/EU, and WEEE directive 2012/19/EU, the following standards are applied:

**EN 55022:2011+AC:2011, Class B**

**EN 55024:2010**

**EN 61204-3:2000, Class B**

**IEC 61000-4 Series**

**EN 61000-3-2:2014**

**EN 61000-3-3:2013**

**EN 60950-1:2006+A11:2009+A1:2010+A12:2011+A2:2013**

**IEC 60950-1:2005 (2<sup>nd</sup> Edition); Am 1:2009+Am 2:2013**

A handwritten signature in black ink, appearing to read "Ryan Smoot".

**Ryan Smoot**

Technical Support Engineer

CUI Inc.

May 17, 2016

**B1.3 CE DECLARATIONS FOR DISCONTINUED POWER SUPPLIES**



**DECLARATION OF CONFORMITY**

We: **Lake Shore Cryotronics, Inc.**  
**575 McCorkle Blvd.**  
**Westerville, OH 43082 USA**

hereby declare that the equipment specified conforms to the following Directives and Standards:

Application of Council Directives..... **2004/108/EC** EMC  
**2011/65/EU** RoHS

Standards to which Conformity is declared..... **EN 61326-1:2013**  
Class A  
Annex B  
**EN 50581:2012**

Model Number..... **211A**

 **9/23/2013**  
**Scott Ayer**

**Director of Quality and Compliance**  
*Position*



20050 SW 112<sup>th</sup> Ave  
Tualatin, OR 97062  
Phone: (800) 275-4899  
Fax: (503) 612-2383

---



**EC – Declaration Of Conformity**

For the following equipment:

Switching Power Supply

**Part Number: EMSA050120-P5P-SZ**

**Model Number: 3A-066WP05**

Imported By:

CUI, Inc.  
20050 SW 112<sup>th</sup> Ave  
Tualatin, OR 97062

is herewith confirmed to comply with the requirements set out in the Council Directive on the Approximation of the Laws of the Member States relating to the Electromagnetic Compatibility Directive 2004/108/EC and Low Voltage Directive 2006/95/EC. For the evaluation regarding the Electromagnetic Compatibility 2004/108/EC and Low Voltage Directive 2006/95/EC, the following standards are applied:

EN55022:2006+A1:2007, Class B  
EN55024:1998+A1: 2001+A2:2003  
EN61000-3-2: 2006  
EN61000-3-3: 2008  
EN61204-3: 2000, Class B  
EN60950-1:2006+A11:2009

A handwritten signature in black ink, appearing to read "Ryan Smoot".

Ryan Smoot  
Technical Support Engineer  
CUI, Inc. February 15, 2011



20050 SW 112<sup>th</sup> Ave  
Tualatin, OR 97062  
Phone: (800) 275-4899  
Fax: (503) 612-2381

---



**EC – Declaration Of Conformity**  
For the following equipment:

Switching Power Supply  
**Part Number: EMS050120-P5P-SZ**  
**Model Number: 3A-061WP05**

Imported By:  
CUI, Inc.  
20050 SW 112<sup>th</sup> Ave  
Tualatin, OR 97062

is herewith confirmed to comply with the requirements set out in the Council Directive on the Approximation of the Laws of the Member States relating to the Electromagnetic Compatibility Directive (89/336/EEC, Amended by 92/31/EEC & 93/68/EEC). For the evaluation regarding the Electromagnetic Compatibility (89/336/EEC, Amended by 92/31/EEC & 93/68/EEC) the following standards are applied:

UL 60950-1  
EN 55022: 1998+A1: 2000+A2: 2003  
EN 55024: 1998+A1: 2001  
EN 61000-3-2: 2000  
EN 61000-3-3: 1995+A1: 2001

  
Albert Rfcker  
QC Product Specialist  
CUI, Inc. May 7, 2008



振源(厦门)工业有限公司

TJIN GOAN (XIAMEN) INDUSTRIAL LTD.

中国厦门湖里区兴隆路振源大厦

Tjin Goan Building, Xinglong Rd, Huli 361006, Xiamen, P.R.C

CABLE: 6110

TEL: 592-6020142 6033645 6033646 6033647 6033648

FAX: 592-6020141



EU Declaration of Conformity



according to the Low Voltage Directive 73/23/EEC and EMC

Directive 89/336/EEC, 92/31/EEC with the Amendment Directive 93/68/EEC For the following equipment

Product : IB05U05LR  
Type Designation Trademark : TGI  
Manufacturer's Name : TJIN GOAN (XIAMEN) INDUSTRIAL LTD.  
Manufacturer's Address : Tjin Goan Building, Xinglong Rd, Huli 361006, Xiamen, P.R.C

Is herewith confirm to comply with the requirements set out in the Council Directive 73/23/EEC for electrical equipment used within certain voltage limits and the Amendment Directive 93/68/EEC For the evaluation of the compliance with this Directives 89/336/EEC, the following standards were applied:

EN60950-1:2001, EN55022:1999 EN55024/A2:2003 EN61000

Responsible for making this declaration is the:

Manufacturer  authorized representative established within the EU

Authorized representative established within the EU(a applicable):

Company Name : TJIN GOAN (XIAMEN) INDUSTRIAL LTD.  
Company Address : Tjin Goan Building, Xinglong Rd, Huli 361006, Xiamen, P.R.C

Person responsible for making this declaration

Name : LI SHIHUANG  
Position/Title : PRESIDENT

TJIN GOAN (XIAMEN) INDUSTRIAL LTD.

XIAMEN JUNE 30 2006

## B1.4 ROHS DECLARATIONS FOR DISCONTINUED POWER SUPPLIES



www.cui.com

20050 SW 112th Ave. Tualatin, Oregon 97062

phone 503.612.2300 toll free 800.275.4899 fax 503.612.2383

---

### **CERTIFICATE OF COMPLIANCE- RoHS Declaration For the following equipment:**

#### **EMSA050120**

Imported by:  
CUI Inc.  
20050 SW 112th Ave.  
Tualatin, OR 97062

This is to certify that all components listed above are RoHS compliant, meet the requirements of the current RoHS Directive 2002/95/EC, and do not contain above the specified limits any of the below banned substances:

- Lead
- Mercury
- Polybrominated Biphenyls (PBB)
- Hexavalent Chromium
- Cadmium
- Polybrominated Diphenylethers (PBDE) (including DecaBDE)

A handwritten signature in black ink, appearing to read 'Jeff Smoot', written over a horizontal line.

Jeff Smoot  
Product Compliance Manager  
CUI Inc.  
1.800.275.4899  
[jsmoot@cui.com](mailto:jsmoot@cui.com)

24 May 2010



**CUI INC**

9615 SW Allen Blvd Ste 103  
Beaverton, OR 97005  
P: 503.643.4899  
F: 503.372.1266



POWER SUPPLIES



SPEAKERS



SWITCHING POWER



ENCODERS



TRANSFORMERS



CONNECTORS

800.275.4899 | [www.cui.com](http://www.cui.com)

## CUI Inc

### CERTIFICATE OF COMPLIANCE- RoHS Declaration For the Following equipment:

<b>EMS050120-P5P-SZ</b>	<b>EMS120050-P6P-SZ</b>
<b>EMS060100-P5P-SZ</b>	<b>EMS150040-P5P-SZ</b>
<b>EMS090066-P5P-SZ</b>	<b>EMS180033-P5P-SZ</b>
<b>EMS120050-P5P-SZ</b>	<b>EMS240025-P5P-SZ</b>

#### Imported By:

CUI Inc  
9615 SW Allen Blvd, Suite 103  
Beaverton, OR 97005

This is to certify that all components listed above are RoHS compliant and meet the requirements of the current RoHS Directive 2002/95/EC and do not contain above the specified limits any of the below banned substances:

- Lead
- Mercury
- Polybrominated Biphenyls (PBB)
- Hexavalent Chromium
- Cadmium
- Polybrominated Diphenylethers (PBDE)

Jeff Smoot  
Product Compliance Manager  
CUI Inc  
1800.275.4899  
[jsmoot@cui.com](mailto:jsmoot@cui.com)

February 15, 2006



振源(厦门)工业有限公司

TJIN GOAN (XIAMEN) INDUSTRIAL LTD.

中国厦门湖里区兴隆路振源大厦

Tjin Goan Building, Xinglong Rd, Huli 361006, Xiamen, P.R.C

CABLE: 6110

TEL: 592-6020142 6033645 6033646 6033647 6033648

FAX: 592-6020141

### Declaration of Conformity

Model: SW0510

APX Part number: IB05U05LR

TJIN GOAN complies with the EU-Directive 2002/96/EC (WEEE);  
EU-Directive 2003/11/EC(Council Directive 76/769/EEC) and EU-Directive  
2002/95/EC on Restriction on the use of certain hazardous substances  
(RoHS) in electrical and electronic equipment.

TJIN GOAN Products do not use the restricted hazardous substances  
such as mercury, hexavalent-chromium, polybrominated biphenyls (PBB)  
and polybrominated diphenyl ethers (PBDE)

TJIN GOAN (xiamen) Industrial Ltd.,

  
\_\_\_\_\_  
Shihuang Li/ General Manager

Date: Oct. 30, 2006



## APPENDIX C

### MENU STRUCTURE

<b>Model 211 Menu Structure</b>	
<b>inPUt</b>	<b>Input Setup Settings</b>
—	<i>Input Type</i>
5 i	Si (Silicon Diode)
GAALAS	GaAlAs (Gallium Aluminum Arsenide Diode)
250 Pt	250 Pt (PT-100, 250 Ω Range)
500 Pt	500 Pt (PT-100, 500 Ω Range)
1000Pt	1000 Pt (PT-1000, 5 kΩ Range)
ntcrtd	NTCRD (Neg. Temp. Coefficient RTD)
—	<i>Input Curve (Selections depend on input type)</i>
nonE	None
dt470	DT-470
dt670	DT-670
Et i	DT-670
Pt 100	PT-100
Pt 1000	PT-1000
USER	User
Un ItS	<i>Display Units (front panel LEDs)</i>
—	°C (Celsius)
—	°F (Fahrenheit)
—	K (kelvin)
—	V/Ω (Sensor Units)
<b>OUTPUt</b>	<b>Analog Output Settings</b>
—	<i>Analog Output Mode</i>
voLt	Voltage
CUr	Current
—	<i>Analog Output Range</i>
rnG 0	0 = 0 to 20 K
rnG 1	0 = 0 to 100 K
rnG 2	0 = 0 to 200 K
rnG 3	0 = 0 to 325 K
rnG 4	0 = 0 to 475 K
rnG 5	0 = 0 to 1000 K
<b>ALR</b>	<b>Alarm Settings</b>
—	<i>Alarm Mode</i>
AL OFF	Off
AL On	On
H	<i>High Setpoint</i>
L	<i>Low Setpoint</i>
d	<i>Deadband</i>
—	<i>Latching</i>
Ltch 0	0 = Off
Ltch 1	1 = On
<b>RELAY</b>	<b>Relay Settings</b>
—	<i>Relay 1 Mode</i>
r1 OFF	Off
r1 On	On
r1 ALR	Alarms
—	<i>Relay 2 Mode</i>
r2 OFF	Off
r2 On	On
r2 ALR	Alarms

---

***Lake Shore*** is a technology leader in the development of cryogenic temperature sensors, precision low temperature measurement and control instrumentation, and magnetic measurement and test systems. Since 1968, Lake Shore physicists, material scientists, and engineers have dedicated themselves to the development of tomorrow's technology today. Lake Shore serves a worldwide network of Customers including university and national laboratories, aerospace and other industries, as well as many of the premier companies around the world.

---