

User's Manual  
**Model 121**  
Programmable DC  
Current Source



Lake Shore Cryotronics, Inc.  
575 McCorkle Blvd.  
Westerville, Ohio 43082-8888 USA

sales@lakeshore.com  
service@lakeshore.com  
www.lakeshore.com

---

Fax: (614) 891-1392 ■ Telephone: (614) 891-2243

Methods and apparatus disclosed and described herein have been developed solely on company funds of Lake Shore Cryotronics, Inc. No government or other contractual support or relationship whatsoever has existed which in any way affects or mitigates proprietary rights of Lake Shore Cryotronics, Inc. in these developments. Methods and apparatus disclosed herein may be subject to U.S. Patents existing or applied for. Lake Shore Cryotronics, Inc. reserves the right to add, improve, modify, or withdraw functions, design modifications, or products at any time without notice. Lake Shore shall not be liable for errors contained herein or for incidental or consequential damages in connection with furnishing, performance, or use of this material.

# **LIMITED WARRANTY STATEMENT**

## **WARRANTY PERIOD: THREE (3) YEARS**

1. Lake Shore warrants that products manufactured by Lake Shore (the "Product") will be free from defects in materials and workmanship for three years from the date of Purchaser's physical receipt of the Product (the "Warranty Period"). If Lake Shore receives notice of any such defects during the Warranty Period and the defective Product is shipped freight prepaid back to Lake Shore, Lake Shore will, at its option, either repair or replace the Product (if it is so defective) without charge for parts, service labor or associated customary return shipping cost to the Purchaser. Replacement for the Product may be by either new or equivalent in performance to new. Replacement or repaired parts, or a replaced Product, will be warranted for only the unexpired portion of the original warranty or 90 days (whichever is greater)..

2. Lake Shore warrants the Product only if the Product has been sold by an authorized Lake Shore employee, sales representative, dealer or an authorized Lake Shore original equipment manufacturer (OEM).

3. The Product may contain remanufactured parts equivalent to new in performance or may have been subject to incidental use when it is originally sold to the Purchaser.

4. The Warranty Period begins on the date the Product ships from Lake Shore's plant.

5. This limited warranty does not apply to defects in the Product resulting from (a) improper or inadequate installation (unless OT&V services are performed by Lake Shore), maintenance, repair or calibration, (b) fuses, software, power surges, lightning and non-rechargeable batteries, (c) software, interfacing, parts or other supplies not furnished by Lake Shore, (d) unauthorized modification or misuse, (e) operation outside of the published specifications, (f) improper site preparation or site maintenance (g) natural disasters such as flood, fire, wind, or earthquake, or (h) damage during shipment other than original shipment to you if shipped through a Lake Shore carrier.

6. This limited warranty does not cover: (a) regularly scheduled or ordinary and expected recalibrations of the Product; (b) accessories to the Product (such as probe tips and cables, holders, wire, grease, varnish, feed throughs, etc.); (c) consumables used in conjunction with the Product (such as probe tips and cables, probe holders, sample tails, rods and holders, ceramic putty for mounting samples, Hall sample cards, Hall sample enclosures, etc.); or, (d) non-Lake Shore branded Products that are integrated with the Product.

7. To the extent allowed by applicable law,, this limited warranty is the only warranty applicable to the Product and replaces all other warranties or conditions, express or implied, including, but not limited to, the implied warranties or conditions of merchantability and fitness for a particular purpose. Specifically, except as provided herein,

LakeShore undertakes no responsibility that the products will be fit for any particular purpose for which you may be buying the Products. Any implied warranty is limited in duration to the warranty period. No oral or written information, or advice given by the Company, its Agents or Employees, shall create a warranty or in any way increase the scope of this limited warranty. Some countries, states or provinces do not allow limitations on an implied warranty, so the above limitation or exclusion might not apply to you. This warranty gives you specific legal rights and you might also have other rights that vary from country to country, state to state or province to province.

8. Further, with regard to the United Nations Convention for International Sale of Goods (CISG,) if CISG is found to apply in relation to this agreement, which is specifically disclaimed by Lake Shore, then this limited warranty excludes warranties that: (a) the Product is fit for the purpose for which goods of the same description would ordinarily be used, (b) the Product is fit for any particular purpose expressly or impliedly made known to Lake Shore at the time of the conclusion of the contract. (c) the Product is contained or packaged in a manner usual for such goods or in a manner adequate to preserve and protect such goods where it is shipped by someone other than a carrier hired by Lake Shore.

9. Lake Shore disclaims any warranties of technological value or of non-infringement with respect to the Product and Lake Shore shall have no duty to defend, indemnify, or hold harmless you from and against any or all damages or costs incurred by you arising from the infringement of patents or trademarks or violation or copyrights by the Product.

10. THIS WARRANTY IS NOT TRANSFERRABLE. This warranty is not transferrable.

11. Except to the extent prohibited by applicable law, neither Lake Shore nor any of its subsidiaries, affiliates or suppliers will be held liable for direct, special, incidental, consequential or other damages (including lost profit, lost data, or downtime costs) arising out of the use, inability to use or result of use of the product, whether based in warranty, contract, tort or other legal theory, regardless whether or not Lake Shore has been advised of the possibility of such damages. Purchaser's use of the Product is entirely at Purchaser's risk. Some countries, states and provinces do not allow the exclusion of liability for incidental or consequential damages, so the above limitation may not apply to you.

12. This limited warranty gives you specific legal rights, and you may also have other rights that vary within or between jurisdictions where the product is purchased and/or used. Some jurisdictions do not allow limitation in certain warranties, and so the above limitations or exclusions of some warranties stated above may not apply to you.

13. Except to the extent allowed by applicable law, the terms of this limited warranty statement do not exclude, restrict or modify the mandatory statutory rights applicable to the sale of the product to you.

## **CERTIFICATION**

Lake Shore certifies that this product has been inspected and tested in accordance with its published specifications and that this product met its published specifications at the time of shipment. The accuracy and calibration of this product at the time of shipment are traceable to the United States National Institute of Standards and Technology (NIST); formerly known as the National Bureau of Standards (NBS).

## **FIRMWARE LIMITATIONS**

Lake Shore has worked to ensure that the Model 121 firmware is as free of errors as possible, and that the results you obtain from the instrument are accurate and reliable. However, as with any computer-based software, the possibility of errors exists.

In any important research, as when using any laboratory equipment, results should be carefully examined and rechecked before final conclusions are drawn. Neither Lake Shore nor anyone else involved in the creation or production of this firmware can pay for loss of time, inconvenience, loss of use of the product, or property damage caused by this product or its failure to work, or any other incidental or consequential damages. Use of our product implies that you understand the Lake Shore license agreement and statement of limited warranty.

## **FIRMWARE LICENSE AGREEMENT**

The firmware in this instrument is protected by United States copyright law and international treaty provisions. To maintain the warranty, the code contained in the firmware must not be modified. Any changes made to the code is at the user's risk. Lake Shore will assume no responsibility for damage or errors incurred as result of any changes made to the firmware.

Under the terms of this agreement you may only use the Model 121 firmware as physically installed in the instrument. Archival copies are strictly forbidden. You may not decompile, disassemble, or reverse engineer the firmware. If you suspect there are problems with the firmware, return the instrument to Lake Shore for repair under the terms of the Limited Warranty specified above. Any unauthorized duplication or use of the Model 121 firmware in whole or in part, in print, or in any other storage and retrieval system is forbidden.

## **TRADEMARK ACKNOWLEDGMENT**

Many manufacturers and sellers claim designations used to distinguish their products as trademarks. Where those designations appear in this manual and Lake Shore was aware of a trademark claim, they appear with initial capital letters and the <sup>TM</sup> or <sup>®</sup> symbol.

Cernox<sup>®</sup> is a trademarks of Lake Shore Cryotronics, Inc.

Microsoft Windows<sup>®</sup>, Excel<sup>®</sup>, Windows XP<sup>®</sup>, and Windows Vista<sup>®</sup> are registered trademarks of Microsoft Corporation in the United States and other countries.

---

Copyright 2013-2017 by Lake Shore Cryotronics, Inc. All rights reserved. No portion of this manual may be reproduced, stored in a retrieval system, or transmitted, in any form or by any means, electronic, mechanical, photocopying, recording, or otherwise, without the express written permission of Lake Shore.

## Electromagnetic Compatibility (EMC) for the Model 121 Current Source

Electromagnetic Compatibility (EMC) of electronic equipment is a growing concern worldwide. Emissions of and immunity to electromagnetic interference is now part of the design and manufacture of most electronics. To qualify for the CE Mark, the Model 121 meets or exceeds the requirements of the European EMC Directive 89/336/EEC as a CLASS A product. A Class A product is allowed to radiate more RF than a Class B product and must include the following warning:

**WARNING:**This is a Class A product. In a domestic environment, this product may cause radio interference in which case the user may be required to take adequate measures.

The instrument was tested under normal operating conditions with sensor and interface cables attached. If the installation and operating instructions in the User's Manual are followed, there should be no degradation in EMC performance.

This instrument is not intended for use in close proximity to RF Transmitters such as two-way radios and cell phones. Exposure to RF interference greater than that found in a typical laboratory environment may disturb the sensitive measurement circuitry of the instrument.

Pay special attention to instrument cabling. Improperly installed cabling may defeat even the best EMC protection. For the best performance from any precision instrument, follow the grounding and shielding instructions in the User's Manual. In addition, the installer of the Model 121 should consider the following:

- Shield measurement and computer interface cables.
- Leave no unused or unterminated cables attached to the instrument.
- Make cable runs as short and direct as possible. Higher radiated emissions are possible with long cables.
- Do not tightly bundle cables that carry different types of signals.



# Table of Contents

## Chapter 1: Introduction

1.1 Overview .....	1
1.2 Applications .....	2
1.3 Model 121 Specifications .....	3
1.3.1 Output .....	3
1.3.2 User setting .....	3
1.3.2.1 Programming .....	3
1.3.2.2 Front panel .....	4
1.3.2.3 Interface .....	4
1.3.3 General .....	4
1.4 Safety Summary and Symbols .....	4

## Chapter 2: Installation

2.1 General .....	7
2.2 Inspecting and Unpacking .....	7
2.3 Rear Panel Definition .....	8
2.4 Power Input Connector .....	9
2.5 External Power Supply .....	9
2.6 Cable Clamp .....	10
2.7 Current Source Output .....	10
2.7.1 Current Source Output Connector .....	10
2.7.2 Sensor Lead Cable .....	11
2.7.3 Grounding and Shielding Sensor Leads .....	11
2.7.4 Sensor Polarity .....	12
2.7.4.1 Resistive Sensors .....	12
2.7.4.2 Diode Sensors .....	12
2.7.4.3 Hall Generators .....	13
2.7.5 Lowering Measurement Noise .....	14
2.8 Rack Mounting .....	14

## Chapter 3: Operation

3.1 General .....	15
3.2 Instrument Power .....	15
3.3 Front Panel Description .....	16
3.3.1 Keypad Definitions .....	16
3.3.2 Display Annunciators .....	16
3.4 Display Brightness .....	17
3.5 Output Current Setup .....	17

3.5.1 Enable/Disable .....	17
3.5.2 Range Change .....	17
3.5.3 Polarity Change .....	18
3.5.4 User Current .....	19
3.5.5 Power Up Enable.....	19
3.6 Power Up State .....	19
3.7 Locking and Unlocking the Keypad .....	20

## Chapter 4: Computer Interface Operation

4.1 General .....	21
4.2 USB Interface .....	21
4.2.1 Physical Connection .....	21
4.2.2 Hardware Support.....	21
4.2.3 Installing the USB Driver .....	22
4.2.3.1 Installing the Driver From Windows® Update in Windows Vista®, Windows® 7, and Windows® 8 ....	22
4.2.3.2 Installing the Driver From Windows® Update in Windows® XP .....	23
4.2.3.3 Installing the Driver from the Web .....	23
4.2.3.3.1 Download the driver .....	23
4.2.3.3.2 Extract the driver .....	24
4.2.3.3.3 Manually install the driver .....	24
4.2.3.4 Installing the USB Driver from the Included CD ....	26
4.2.4 Communication .....	27
4.2.4.1 Character Format .....	27
4.2.4.2 Message Strings .....	27
4.2.5 Message Flow Control .....	28
4.3 Command Summary .....	29
4.3.1 Interface Commands .....	30

## Chapter 5: Options and Accessories

5.1 General .....	35
5.2 Models .....	35
5.3 Accessories .....	35

## Chapter 6: Service

6.1 General .....	37
6.2 USB Troubleshooting .....	37
6.2.1 New Installation .....	37
6.2.2 Existing Installation No Longer Working .....	38
6.2.3 Intermittent Lockups .....	38



6.3	Factory Reset	39
6.4	Product Information	39
6.5	Error Messages	39
6.6	Calibration Procedure	39
6.7	Rear Panel Connector Definition	40
6.8	Firmware Updates	41
6.8.1	Updating the Firmware	41
6.8.2	Record of Updates Made to the Firmware	41
6.9	Technical Inquiries	42
6.9.1	Contacting Lake Shore	42
6.9.2	Return of Equipment	42
6.9.3	RMA Valid Period	43
6.9.4	Shipping Charges	43
6.9.5	Restocking Fee	43

## **Appendix A: Handling Liquid Helium and Nitrogen**

A.1	General	45
A.2	Properties	45
A.3	Handling Cryogenic Storage Dewars	46
A.4	Liquid Helium and Nitrogen Safety Precautions	46
A.5	Recommended First Aid	48

## **Appendix B: Regulatory Declarations**

B.1	General	49
B.1.1	CE Declaration for Model 121	50
B.1.2	CE Declaration for the Power Supply, Part Number 109-132	51



# Chapter 1: Introduction

## 1.1 Overview

The Model 121 programmable DC current source is a precision instrument suitable for bench-top use or panel-mounted operation in labs, test facilities, and manufacturing environments. It provides a low noise, highly-stable source of current up to 100 mA, with convenient manual selection through 13 pre-set output levels, each representing a ten-fold change in power when attached to a resistive load. A “user” setting allows the current output to be defined anywhere within the operating range of the unit, from 100 nA to 100 mA.

Programmable operation is also possible via the instrument’s USB computer interface, through which the Model 121 can be commanded to output any desired current at any time. Thus, application-specific test currents can be driven from an external PC.

The instrument operates at 5 VDC, and power is supplied by the external AC wall-mount supply provided with the standard Model 121. The supply will automatically conform to any AC line voltage ranging from 100 VAC to 240 VAC, 50 or 60 Hz.

- 7 decades of output current, selectable in 13 steps
- Programmable current output, 100 nA to 100 mA
- Low-noise output
- Large 3 digit LED display
- Simple user interface
- Current reversal feature
- USB interface enables integration with automated test systems
- DIN panel-mountable package
- Detachable output terminal block
- CE mark certification

## 1.2 Applications

The Model 121 current source is ideally suited for testing, measuring, and operating resistive and semiconductor devices, such as:

- Lake Shore Cernox™ temperature sensors
- Other resistance temperature detectors (RTDs) such as platinum sensors
- Diode temperature sensors, including Lake Shore DT-670's
- LED devices
- Hall sensors used for magnetic field measurement

An accurate, stable source of current is key to ensuring consistent operation of these devices, where the voltage drop across the device can be dependent upon temperature, magnetic field, and other parameters. The instrument's wide output range is of great value when used with RTD-type sensors whose resistance can vary with temperature by as much as 6 orders of magnitude. The current reversal feature enables compensation for thermal EMF, important for accurately measuring resistors at very low excitation levels.

Example applications include:

- Basic device QC ("good/bad" verification)
- LED brightness testing (constant device current)
- Temperature sensor calibration (determine resistance at fixed calibration points)
- Temperature measurement (using a voltmeter readout)
- Magnetic sensor calibration and measurement
- Semiconductor device measurements (IV curves for diodes, transistors, etc.)
- Circuit prototyping (fixed current source)
- Small scale electro-chemical applications

Whether operating over a wide range of environmental conditions, establishing precise sensor calibrations or simply testing devices for conformance, the Model 121 provides a convenient and reliable alternative to simple voltage-based circuits, and a very affordable alternative to more expensive multi-function current sources. It can be readily integrated into automated test systems using its built-in USB computer interface and offers a highly readable, simple-to-use operator display.

## 1.3 Model 121 Specifications

### 1.3.1 Output

**Type:** Bipolar, DC current source

**Current ranges:** 13 fixed ranges of 100 nA, 300 nA, 1  $\mu$ A, 3  $\mu$ A, 10  $\mu$ A, 30  $\mu$ A, 100  $\mu$ A, 300  $\mu$ A, 1 mA, 3 mA, 10 mA, 30 mA, 100 mA, and a user-programmable range

**Accuracy:** 0.05% on 10  $\mu$ A range, 0.5% on 100 nA and 300 nA ranges, 0.1% on all other ranges

**Compliance voltage:**  $\pm 11$  V up to 30 mA,  $\pm 10$  V up to 100 mA

**AC current ripple:**  $< 0.1\%$  on 100 nA and 300 nA ranges;  $< 0.01\%$  on all other ranges in a properly shielded system

**Current ripple frequency:** Dominated by line frequency and its harmonics

**Temperature coefficient:** 0.03% of range/ $^{\circ}$ C for the 100 nA range, 0.01% of range/ $^{\circ}$ C for all other ranges

**Line regulation:**  $< 0.01\%$  change in output for 5% change in the DC input voltage

**Load regulation:**  $< 0.01\%$  change in output current over the full-scale range

**Stability (24 h):** 0.05% on 100 nA range, 0.01% per day on all other fixed ranges

**Settling time:**  $< 300$  ms for full-scale change in current;  $< 100$  ms for 10% change in current

**Connector:** Detachable terminal block

**Maximum load:** 300 k $\Omega$

### 1.3.2 User setting

#### 1.3.2.1 Programming

**Operation:** Output current settable via computer interface

**Resolution:** 3 significant digits

**Accuracy:** 0.5% for currents  $< 300$  nA, 0.25% for all other currents

**Maximum current:** 100 mA

**Minimum current:** 100 nA

### 1.3.2.2 Front panel

**Display:** 6-digit LED display

**Display units:** mA,  $\mu$ A, and nA

**Display update rate:** 2 rdg/s

**Display annunciators:** mA,  $\mu$ A, nA, and compliance

**Keypad:** 4 full-travel keys

**Keypad functions:** Range Up, Range Down, Current Polarity, Enable/Disable

### 1.3.2.3 Interface

**USB Function:** Emulates an RS-232 serial port

**Baud rate:** 57,600

**Connector:** B-type USB connector

**Reading rate:** Up to 10 rdg/s

**Software support:** LabVIEW™ driver (consult Lake Shore for availability)

## 1.3.3 General

**Ambient temperature:** 15 °C to 35 °C at rated accuracy; 5 °C to 40 °C at reduced accuracy

**Power requirement:** +5 VDC  $\pm$ 5% at 250 mA, barrel plug 5.5 mm OD  $\times$  2.1 mm ID  $\times$  9.9 mm L

**Size:** 96 mm W  $\times$  48 mm H  $\times$  166 mm D (3.8 in  $\times$  1.9 in  $\times$  6.5 in)

**Mounting:** Panel mount into 91 mm W  $\times$  44 mm H (3.6 in  $\times$  1.7 in) cutout

**Weight:** 0.45 kg (1 lb)

**Approval:** CE Mark

## 1.4 Safety Summary and Symbols

Observe these general safety precautions during all phases of instrument operation, service, and repair. Failure to comply with these precautions or with specific warnings elsewhere in this manual violates safety standards of design, manufacture, and intended instrument use. Lake Shore Cryotronics, Inc. assumes no liability for Customer failure to comply with these requirements.

The Model 121 protects the operator and surrounding area from electric shock or burn, mechanical hazards, excessive temperature, and spread of fire from the instrument. Environmental conditions outside of the conditions below may pose a hazard to the operator and surrounding area.

- Indoor use
- Altitude to 2000 m
- Temperature for safe operation: 5 °C to 40 °C
- Maximum relative humidity: 80% for temperature up to 31 °C decreasing linearly to 50% at 40 °C
- Power supply voltage fluctuations not to exceed  $\pm 10\%$  of the nominal voltage\*
- Overvoltage category II
- Pollution degree 2

*\*The power supply included with the Model 121 meets or exceeds the European Union Standard, EN-60950.*

#### *Do Not Operate in an Explosive Atmosphere*

Do not operate the instrument in the presence of flammable gases or fumes. Operation of any electrical instrument in such an environment constitutes a definite safety hazard.

#### *Keep Away from Live Circuits*

Operating personnel must not remove instrument covers. Refer component replacement and internal adjustments to qualified maintenance personnel. Do not replace components with power cable connected. To avoid injuries, always disconnect power and discharge circuits before touching them.

#### *Do Not Substitute Parts or Modify Instrument*

Do not install substitute parts or perform any unauthorized modification to the instrument. Return the instrument to an authorized Lake Shore Cryotronics, Inc. representative for service and repair to ensure that safety features are maintained.

#### *Cleaning*

Do not submerge instrument. Clean only the exterior of the instrument with a damp cloth and mild detergent.













	Direct current (power line)		Equipment protected throughout by double insulation or reinforces insulation (equivalent to Class II of IEC 536—see Annex H)
	Alternating current (power line)		
	Alternating or direct current (power line)		CAUTION: High voltages; danger of electric shock; background color: yellow; symbol and outline: black
	Three-phase alternating current (power line)		
	Earth (ground) terminal		
	Protective conductor terminal		CAUTION or WARNING: See instrument documentation; background color: yellow; symbol and outline: black
	Frame or chassis terminal		
	On (supply)		
	Off (supply)		

FIGURE 1-1 Safety symbols



## Chapter 2: Installation

### 2.1 General

This chapter provides general installation instructions for the Model 121 current source. Please read this entire chapter before installing the instrument and powering it on to ensure the best possible performance and maintain operator safety. For instrument operating instructions refer to Chapter 3. For computer interface installation and operation refer to Chapter 4.

### 2.2 Inspecting and Unpacking

Inspect shipping containers for external damage before opening them. Photograph any container that has significant damage before opening it. Inspect all items for both visible and hidden damage that may have occurred during shipment. If there is visible damage to the contents of the container, contact the shipping company and Lake Shore immediately, preferably within five days of receipt of goods, for instructions on how to file a proper insurance claim. Lake Shore products are insured against damage during shipment, but a timely claim must be filed before Lake Shore will take further action. Procedures vary slightly with shipping companies. Keep all damaged shipping materials and contents until instructed to either return or discard them.

Open the shipping container and keep the container and shipping materials until all contents have been accounted for. Check off each item on the packing list as it is unpacked. Instruments themselves may be shipped as several parts. The items included with the Model 121 are listed below. Contact Lake Shore immediately if there is a shortage of parts or accessories. Lake Shore is not responsible for any missing items if not notified within 60 days of shipment.

If the instrument must be returned for recalibration, replacement or repair, a Return Authorization (RMA) number must be obtained from a factory representative before it is returned. Refer to section 6.9.3 for the Lake Shore RMA procedure.

Items Included with Model 121 current source:

- 1 Model 121 instrument
- 1 Model 121 user's manual

- 1 terminal block mating connector, 2-pin terminal block, for current source output (G-106-735)
- 4 adhesive square rubber feet
- 1 cable clamp, for power supply cord
- 1 universal input power supply (interchangeable plug style)\* (109-132)

\* Not included with the 121N option

## 2.3 Rear Panel Definition

This section provides a description of the Model 121 rear panel connections, as shown in FIGURE 2-1. The rear panel consists of the current source output connector, USB B-type connector, and power jack. Installation information for each feature is outlined throughout the next few sections. A summary of the connector pin-outs is provided in section 6.7.

### CAUTION

Always remove power from the instrument before making any rear panel connections. This is especially critical when making sensor to instrument connections.

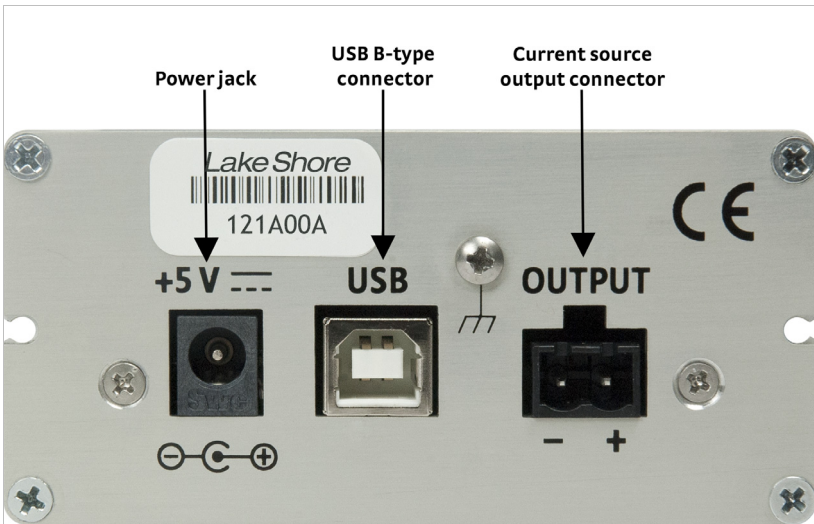

FIGURE 2-1 Model 121 rear panel

## 2.4 Power Input Connector

Power is supplied to the Model 121 through a coaxial connector located on the rear panel of the instrument. There is no power switch on the instrument, so it is off when not plugged in, and on when plugged in. Make sensor connections before applying power to the instrument.

The instrument requires +5 VDC at 250 mA. The coaxial connector accepts a barrel plug 5.5 mm OD x 2.1 mm x 9.9 mm L. Refer to FIGURE 2-2 for polarity.



**To prevent electrical fire or shock hazards, do not expose this instrument, or its power supply, to rain or excess moisture.**

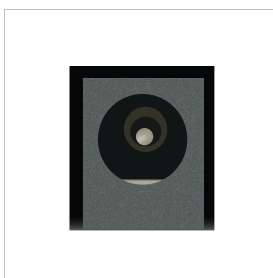

FIGURE 2-2 Power connector

Pin	Description
Inner conductor	+5 V
Outer conductor2	Ground

TABLE 2-1 Power input connector details

## 2.5 External Power Supply

The Model 121 comes with the universal input power supply, Lake Shore P/N 109-132. It can accept input voltages from 100 to 240 VAC ( $\pm 10\%$ ), 50 or 60 Hz. For input power, it has interchangeable plugs to accommodate power receptacles in different countries. It has a barrel plug for the output. It can output +5 VDC at 1.2 A. The power supply is CE certified and meets or exceeds the following safety standards: UL 60950-1 and EN 60950. To change plugs, press the pad on the side of the plug, pull off the old plug, and snap in the new plug.

## 2.6 Cable Clamp

To avoid inadvertent disconnection from the power supply, Lake Shore supplies a cable clamp that the user may attach to the cord and the instrument chassis. It is a part of the accessories kit supplied with the unit. To install the clamp, remove the screw at the top left rear of the unit, position the cord and clamp as shown in the photo and reinstall the screw.



FIGURE 2-3 Cable clamp for the Model 121

## 2.7 Current Source Output

This section details how to connect various sensors to the Model 121 output. Refer to section 3.5 to configure the outputs.

### 2.7.1 Current Source Output Connector

The output connector is a 2-pin terminal block. The output connector pins are defined in FIGURE 2-4 and TABLE 2-2. One mating connector (terminal block mate) is included in the connector kit shipped with the instrument. These are common connectors, so additional mating connectors can be purchased from local electronics suppliers. They can also be ordered from Lake Shore as G-106-735.



**I- cannot be connected to chassis ground.**

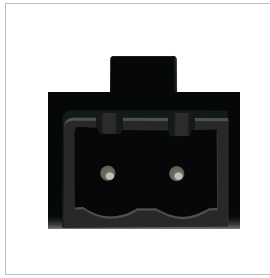

FIGURE 2-4 *Output connector*

Pin	Symbol	Description
1	I+	Current out
2	I-	Current return

TABLE 2-2 *Output current connector details*

## 2.7.2 Sensor Lead Cable

The sensor lead cable used outside the cooling system can be much different from what is used inside. Between the instrument and vacuum shroud, heat leak is not a problem, but errors from noise pick up need to be minimized. Larger conductor, 22 to 28 AWG stranded copper wire is recommended because it has low resistance yet remains flexible when several wires are bundled in a cable.

The arrangement of wires in a cable is also important. For best results, use twisted pair, shielded cable. This type of cable is available through local electronics suppliers. Instrument specifications are given assuming 3 m (10 ft) of sensor cable. Longer cables, 30 m (100 ft) or more, can be used but environment conditions may degrade accuracy and noise specifications.

## 2.7.3 Grounding and Shielding Sensor Leads

The Model 121 does not provide ground referenced leads. This means that I+ and I- cannot be attached to ground in any configuration. The standard power supply (109-132) does not carry earth ground through to chassis. To meet the accuracy specifications at lower current levels the Model 121 must be in a properly shielded system. Since the Model 121 is not connected to earth ground it is important to tie it to measurement common. This connection can be made externally through the chassis

ground connection on the rear panel. It is also advised to use sensor leads that are shielded and floating. The shield should be tied to measurement common. When making any such connections, it is important to avoid ground loops by connecting measurement commons at one point.

## 2.7.4 Sensor Polarity

Lake Shore sensors are shipped with instructions that indicate which sensor leads are which. It is important to follow these instructions for plus and minus leads (polarity) as well as voltage and current when applicable.

### 2.7.4.1 Resistive Sensors

There are two styles of resistive sensor wirings (2-lead and 4-lead). Two-lead resistors can operate with any lead arrangement and the sensor instructions may not specify. Four-lead resistors can be more dependent on lead arrangement. Follow any specified lead assignment for 4-lead resistors. Mixing leads could give a reading that appears correct but is not the most accurate.

### 2.7.4.2 Diode Sensors

For diode sensors, it is important to follow the instructions on polarity, (FIGURE 2-5). This is because diode sensors do not operate in the wrong polarity. Diodes look like an open circuit to the instrument if the positive and negative pins are swapped.

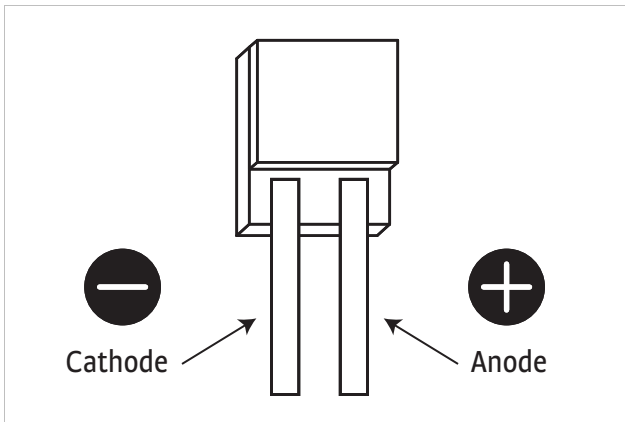

FIGURE 2-5 DT-670-SD diode sensor leads

### 2.7.4.3 Hall Generators

With Hall generators the direction of the current and magnetic field are important to determining the sign of the Hall voltage. As shown in FIGURE 2-6, the current enters the red lead (with  $+I_C$  connected to the positive terminal of the current supply), and the magnetic field direction  $B$  is into the page. With this combination, a positive Hall voltage will be generated at the  $+V_H$  lead. Reversing either the current or the magnetic field will reverse the output voltage.

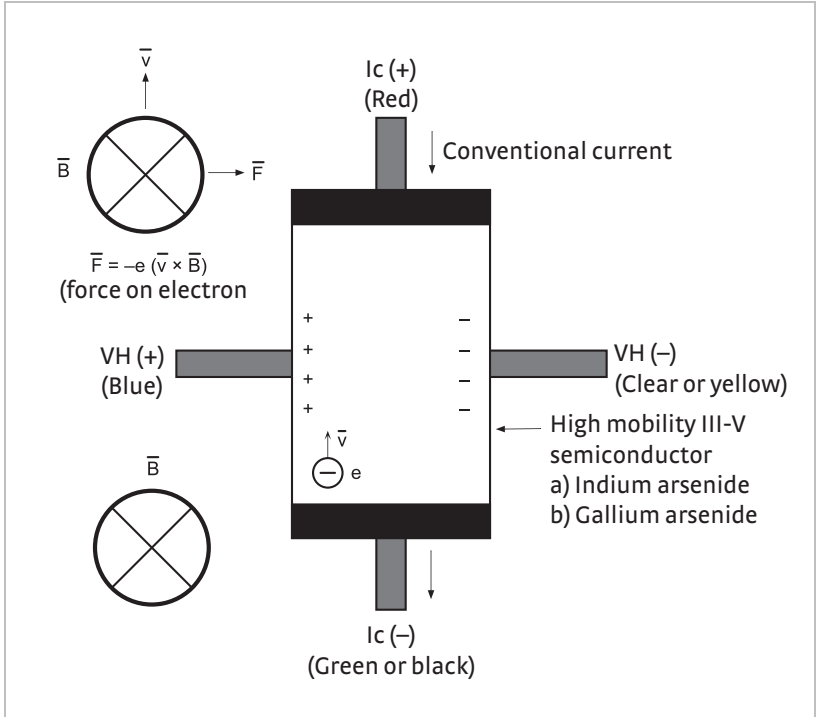

FIGURE 2-6 Hall generator leads

### 2.7.5 Lowering Measurement Noise

Good instrument hardware setup technique is one of the least expensive ways to reduce measurement noise. The suggestions fall into two categories: (1) do not let noise from the outside enter into the measurement, and (2) let the instrument isolation and other hardware features work to their best advantage. Here are some further suggestions:

- Do not connect sensor leads to earth ground or chassis
- Use twisted shielded cable outside the cooling system
- Attach the chassis to the cable shield and to earth ground if possible
- Use twisted wire inside the cooling system
- Consider ground strapping the instrument chassis to other instruments or computers
- Tie all ground points at one common point to avoid ground loops
- For demanding applications, the display can be turned off

## 2.8 Rack Mounting

The Model 121 can be easily mounted using the panel mount brackets included. The Model 121 fits in a  $91 \times 44$  mm ( $3.6 \times 1.7$  in) cutout. To panel-mount the instrument, unplug the unit and use a  $1/16$ -inch hex wrench to remove the two set screws holding the brackets in place. Remove the two panel mount brackets by sliding them towards the rear of the unit. Place the unit into the panel cutout. Slide the two panel mount brackets back into the case of the instrument. Reinstall the two set screws and tighten them until the instrument is secure.

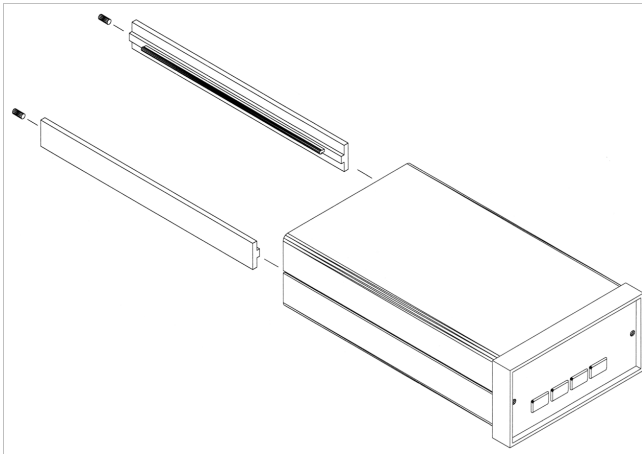

FIGURE 2-7 Rack mounting



## Chapter 3: Operation

### 3.1 General

This chapter provides instructions for the general operating features of the Model 121 current source. Computer interface instructions are in Chapter 4.

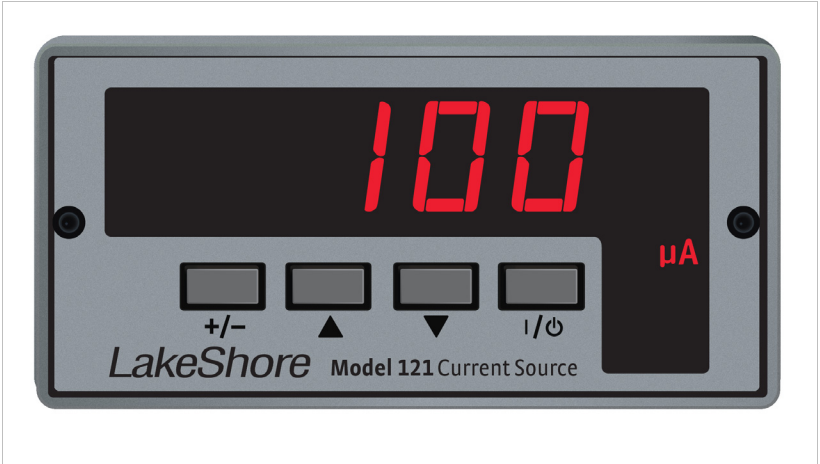

FIGURE 3-1 Model 121 front panel

### 3.2 Instrument Power

The Model 121 is powered on by plugging in the power supply. There is no power switch on the instrument. When the Model 121 is powered on, with no errors present, “121” will illuminate for a few seconds to indicate instrument initialization. The instrument powers up in the power up state with the current disabled. Refer to section 3.6. When the instrument is powered on for the first time, parameters are set to the factory defaults, listed in TABLE 6-1. The instrument should be powered on for thirty minutes before using for rated specifications.

### 3.3 Front Panel Description

The Model 121 has a 6-digit LED display capable of showing both numeric and character data. In normal operation, the display shows the output of the current source. The four annunciators on the lower right hand side of the display indicate the units of the current and whether the instrument is detecting voltage compliance. There are also four keys that allow for manually changing the range, polarity, or disabling the current source output.

#### 3.3.1 Keypad Definitions

The keypad for the Model 121 consists of four keys as described in TABLE 3-1.

Key	Function	Refer to section
+/-	Allows the user to change the polarity of the output current	section 3.5.3
▲	Allows the user to increase the current range	section 3.5.2
▼	Allows the user to decrease the current range	section 3.5.2
I/⏻	Allows the user to enable or disable the output current	section 3.5.1

TABLE 3-1 Keypad definitions

#### 3.3.2 Display Annunciators

Display annunciators include symbols for units of current and voltage compliance.

Annunciator	Function
mA	Indicates that the output current is in units of mA
μA	Indicates that the output current is in units of μA
nA	Indicates that the output current is in units of nA
CMP	Indicates that the instrument is in voltage compliance

TABLE 3-2 Display annunciators

### 3.4 Display Brightness

The front panel 6-digit LED display brightness can be adjusted for optimal viewing. The default value, 8, is recommended for most applications. A setting of zero turns the display off, which may reduce noise in sensitive measurements. This can only be configured through the computer interface. Refer to Chapter 4.

Menu Navigation

Brightness: 0 to 15

Default: 8

Interface Command: **BRIGT**

### 3.5 Output Current Setup

This section explains how to configure the output current through the keypad. Refer to Chapter 4 for information on the computer interface commands. The Model 121 has been optimized to drive resistive sensors (such as Cernox and Platinum Sensors), diode sensors, and Hall generators.

#### 3.5.1 Enable/Disable

The Model 121 allows the user to turn on or turn off the output current by pressing  $I/O$ . When this key is pressed, the display will either read “off” for the disabled state, or the display will show a numeric value for the enabled state. The output current will always power on in the disabled state. In this state the instrument will not output any current.

Menu Navigation

Output: Enabled or Disabled

Default: Disabled

Interface command: **IENBL**

#### 3.5.2 Range Change

The Model 121 allows for the user to change ranges via the  $\blacktriangle$  and  $\blacktriangledown$  keys. The range can be changed to any of the 13 fixed ranges or the user current range using these keys. The user current range can be accessed by pressing  $\blacktriangle$  when in the 100 mA range. The range does not wrap around. For example, when in the USER current range, pressing  $\blacktriangle$  will do nothing.

When changing to a new range, with the current enabled, the new range will flash for 3 s before setting the new current. For the user current range, the instrument will flash “USER” once, and then it will flash the actual value of the user current twice before changing the output current. This allows for the user to select a new range directly without applying intermediate ranges. There is no wait time when making a range change through the computer interface. Refer to Chapter 4.

When changing to a new range with the current disabled, the new range will display for 1 s before the display goes back to displaying “OFF”. The new range will be stored in the memory so when the current is enabled the instrument will go to this new range. When reaching the user current range “USER” will display once before displaying “OFF”.

#### Menu Navigation

Range: 100 nA, 300 nA

Default: 100 nA

Interface Command: **RANGE**

### 3.5.3 Polarity Change

The Model 121 allows for the user to switch the polarity of the current by pressing +/- . This key will switch the polarity of the output current for any of the fixed ranges and user current. The +/- key works independently for the fixed ranges and user current range. Pressing +/- in a fixed range will change the polarity of all fixed ranges, but not the user current. Pressing +/- in the user current range will only change the polarity of the user current. The instrument will immediately change the polarity of the current upon receiving a key press.

#### Menu Navigation

Polarity: Positive or Negative

Default: Positive

Interface Command: **IPOL**

### 3.5.4 User Current

Through the computer interface the Model 121 can be programmed to a current that is between the fixed ranges. This user current is between 100 nA and 100 mA with three digits of resolution. Refer to Chapter 4 to configure the user current setting. When the user range is selected, pressing +/- will change the polarity of the user current, but will not affect the fixed ranges. Refer to section 3.5.3 for more information. The user range is selected by pressing ▲ when in the 100 mA range. The display will then flash “USER” once, then it will flash the user current value twice before setting the user current.

User Current:  $\pm 100$  nA to  $\pm 100$  mA

Default: +100 nA

Interface Command: **SETI**

### 3.5.5 Power Up Enable

The power up enable feature allows the user to choose whether or not the heater range is turned off each time the instrument power is cycled. Setting the Power Up Enable parameter to Off ensures that the Heater Range is turned off on power up. Setting it to On will return the heater range to its previous setting when power is restored.

Interface Command: **PWUPENBL**

## 3.6 Power Up State

The Model 121 can be programmed to power up in a user defined state called the power up state. The power up state consists of three setup parameters: range, polarity, and user current value. To save the power up state, configure the instrument with the desired settings, then press and hold +/- for 3 s. To save it through the computer interface, refer to chapter 4. The power up state will match factory defaults after a factory reset.

## 3.7 Locking and Unlocking the Keypad

The keypad lock feature prevents accidental changes to parameters. When the keypad is locked, the front panel is completely disabled. To

lock the instrument, hold down  $\frac{1}{\psi}$  for 3 s, until the display reads “LOC”. When the keypad is locked all future key presses will cause the display to read “LOC” for 1 s before returning to the previous display. To

unlock the keypad, hold  $\frac{1}{\psi}$  for 3 s, until the display reads “UnLOC.”

Menu Navigation

Keypad: Unlocked or Locked

Default: Unlocked

Interface Command: **LOCK**

## ■ Chapter 4: Computer Interface Operation

### 4.1 General

This chapter provides operational instructions for the computer interface for the Lake Shore Model 121 Current Source. The Model 121 provides a USB interface described in section 4.2. The Model 121 permits remote operation through the USB interface. The interface commands are detailed in section 4.3.

### 4.2 USB Interface

The Model 121 USB interface provides a convenient way to connect to most modern computers. The USB interface is implemented as a virtual serial com port connection. This implementation provides a simple migration path for modifying existing RS-232 based remote interface software. It also provides a simpler means of communicating than a standard USB implementation.

#### 4.2.1 Physical Connection

The Model 121 has a B-type USB connector on the rear panel. This is the standard connector used on USB peripheral devices, and it allows the common USB A-type to B-type cable to be used to connect the Model 121 to a host PC. The pin assignments for A-type and B-type connectors are shown in section 6.7. The maximum length of a USB cable, as defined by the USB 2.0 standard, is 5 m (16.4 ft). This length can be extended using USB hubs every 5 m (16.4 ft) up to 5 times, for a maximum total length of 30 m (98.4 ft).

#### 4.2.2 Hardware Support

The USB interface emulates an RS-232 serial port at a fixed 57,600 baud rate, but with the physical connections of a USB. This programming interface requires a certain configuration to communicate properly with the Model 121. The proper configuration parameters are listed in TABLE 4-1.

<b>Baud rate</b>	57,600
<b>Data bits</b>	7
<b>Start bits</b>	1
<b>Stop bits</b>	1
<b>Parity</b>	Odd
<b>Flow control</b>	None
<b>Handshaking</b>	None

TABLE 4-1 *Host com port configuration*

The USB hardware connection uses the full speed (12,000,000 bits/sec) profile of the USB 2.0 standard; however, since the interface uses a virtual serial com port at a fixed data rate, the data throughput is still limited to a baud rate of 57,600 bits/sec.

### 4.2.3 Installing the USB Driver

The Model 121 USB driver has been made available through Windows® Update. This is the recommended method for installing the driver, as it will ensure that you always have the latest version of the driver installed. If you are unable to install the driver from Windows® Update, refer to section 4.2.3.3 to install the driver from the web or from the disc provided with the Model 121.

These procedures assume that you are logged into a user account that has administrator privileges.

#### 4.2.3.1 Installing the Driver From Windows® Update in Windows Vista®, Windows® 7, and Windows® 8

1. Connect the USB cable from the Model 121 to the computer.
2. Turn on the Model 121.
3. When the Found New Hardware wizard appears, select Locate and install driver software (recommended).
4. If User Account Control (UAC) is enabled, a UAC dialog box may appear asking if you want to continue. Click Continue.
5. The Found New Hardware wizard should automatically connect to Windows® Update and install the drivers.



**If the Found New Hardware wizard is unable to connect to Windows® Update or find the drivers, a message to “insert the disc that came with your Lake Shore Model 121” is displayed. Click Cancel and refer to section 4.2.3.3 to install the driver from the web.**



- When the Found New Hardware wizard finishes installing the driver, a confirmation message stating “the software for this device has been successfully installed” will appear. Click **Close** to complete the installation.

#### 4.2.3.2 Installing the Driver From Windows® Update in Windows® XP

- Connect the USB cable from the Model 121 to the computer.
- Turn on the Model 121.
- When the Found New Hardware wizard appears, select **Yes**, this time only and click **Next**.
- Select **Install the software automatically (Recommended)** and click **Next**.
- The Found New Hardware wizard should automatically connect to Windows® Update and install the drivers.



**If the Found New Hardware wizard is unable to connect to Windows® Update or find the drivers, a message saying “Cannot Install this Hardware” is displayed. Click **Cancel** and refer to section 4.2.3.3 to install the driver from the web.**

- When the Found New Hardware wizard finishes installing the driver a confirmation message stating "the wizard has finished installing the software for Lake Shore Model 121 Current Source" will appear. Click **Finish** to complete the installation.

#### 4.2.3.3 Installing the Driver from the Web

The Model 121 USB driver is available on the Lake Shore website. To install the driver it must be downloaded from the website and extracted. Use the procedure in section 4.2.3.3.1 through section 4.2.3.3.3 to download, extract, and install the driver using Windows® XP, Windows Vista®, Windows® 7, and Windows® 8.

##### 4.2.3.3.1 Download the driver

- Locate the Model 121 USB driver on the downloads page on the Lake Shore website.
- Right-click on the USB driver download link, and select **save target/link as**.
- Save the driver to a convenient place, and take note as to where the driver was downloaded.

#### 4.2.3.3.2 *Extract the driver*

The downloaded driver is in a ZIP compressed archive. The driver must be extracted from this file. Windows® provides built-in support for ZIP archives. If this support is disabled, a third-party application, such as WinZip™ or 7-Zip, must be used.

For Windows Vista®, Windows® 7, and Windows® 8

1. Right click on the file and click **Extract all**.
2. An Extract Compressed (Zipped) Folders dialog box will appear. It is recommended the default folder is not changed. Take note of this folder location.
3. Click to clear the “show extracted files when complete” checkbox, and click **Extract**.

For Windows® XP

1. Right-click on the file and click extract all.
2. The Extraction wizard will appear. Click Next.
3. It is recommended the default folder is not changed. Take note of this folder location and click Next.
4. An "Extraction complete" message is displayed. Click to clear the “show extracted files” checkbox, and click **Finish**.

#### 4.2.3.3.3 *Manually install the driver*

Manually installing drivers differ between versions of Windows®. The following sections describe how to manually install the driver using Windows® XP, Windows Vista®, Windows® 7, and Windows® 8. To install the driver you must be logged into a user account that has administrator privileges.

For Windows Vista®, Windows® 7, and Windows® 8

1. Connect the USB cable from the Model 121 to the computer.
2. Turn on the Model 121.
3. If the Found New Hardware wizard appears, click “ask me again later.”
4. Open Device Manager. Use this procedure to open Device Manager.
  - a. Click the Windows® Start button and type Device Manager in the Start Search box.
  - b. Click on the Device Manager link in the Search Results Under Programs.
  - c. If User Account Control is enabled click Continue on the User Account Control prompt.

5. Click **View** and ensure the **Devices by Type** check box is selected.
6. In the main window of Device Manager, locate **Other Devices** in the list of device types. In many instances this will be between **Network adapters** and **Ports (COM & LPT)**. If the **Other Devices** item is not already expanded, click the + icon. Lake Shore Model 121 should appear indented underneath **Other Devices**. If it is not displayed as Lake Shore Model 121, it might be displayed as **USB Device**. If neither are displayed, click **Action** and then **Scan for hardware changes**, which may open the **Found New Hardware** wizard automatically. If the **Found New Hardware** wizard opens, click **Cancel**.
7. Right-click on Lake Shore Model 121 and click **Update Driver Software**.
8. Click **Browse my computer for driver software**.
9. Click **Browse** and select the location of the extracted driver.
10. Ensure the **Include subfolders** check box is selected and click **Next**.
11. When the driver finishes installing a confirmation message stating "Windows has successfully updated your driver software" should appear.
12. Click **Close** to complete the installation.

#### For Windows® XP

1. Connect the USB cable from the Model 121 to the computer.
2. Turn on the Model 121.
3. The **Found New Hardware** wizard should appear. If the **Found New Hardware** wizard does not appear, the following procedure can be used to open the **Hardware Update** wizard which can be used instead:
  - a. Open **Device Manager**. Use this procedure to open the **Device Manager**:
    - Right-click on **My Computer** and then click **Properties**. This will open the **System Properties** dialog.
    - Click the **Hardware** tab and then click **Device Manager**.
  - b. Click **View** and ensure the **Devices by Type** check box is selected.
  - c. In the main window of **Device Manager**, locate the **Ports (COM & LPT)** device type. In many instances this will be between the **Network adapters** and **Processors** items. If the **Ports (COM & LPT)** item is not already expanded, click the + icon. Lake Shore Model 121 should appear indented underneath **Ports (COM & LPT)**. If it

is not displayed as Lake Shore Model 121, it might be displayed as USB Device. If neither are displayed, click **Action** and then select **Scan** for hardware changes, which may open the Found New Hardware wizard automatically. If the Found New Hardware wizard opens, continue to step 4.

- d. Right-click on Lake Shore Model 121 and click **Update Driver**.
4. Select **No, not at this time** and click **Next**.
5. Select **Search for the best driver in these locations**, click to clear the Search removable media (floppy, CD-ROM...) check box, and click the **Include this location in the search** check box.
6. Click **Browse** and open the location of the extracted driver.
7. Click **Next**.
8. When the driver finishes installing a confirmation message stating "The wizard has finished installing the software for Lake Shore Model 121 Current Source" should appear. Click **Finish** to complete the installation.

#### 4.2.3.4 Installing the USB Driver from the Included CD

The Model 121 USB driver is available on the included CD. The following section describes the process of installing the driver from the CD. To install the driver you must be logged into a user account that has administrator privileges.

For Windows Vista®, Windows® 7, and Windows® 8

1. Insert the CD into the computer.
2. Follow steps 1-9 of the Windows Vista®, Windows® 7, and Windows® 8 procedure in section 4.2.3.3.3.
3. Click **Browse** and select the drive containing the included CD.
4. Ensure the **Include subfolders** check box is selected and click **Next**.
5. When the driver finishes installing a confirmation message stating "Windows has successfully updated your driver software" will appear. Click **Close** to complete the installation.

For Windows® XP

1. Insert the CD into the computer.
2. Connect the USB cable from the Model 121 to the computer.
3. Turn on the Model 121.
4. When the Found New Hardware wizard appears select **No, not at this time** and click **Next**.
5. Select **Install the software automatically (recommended)** and click **Next**.

6. The Found New Hardware wizard should automatically search the CD and install the drivers.
7. When the Found New Hardware Wizard finishes installing the drivers a message stating "the wizard has finished installing the software for Lake Shore Model 121 Current Source" should appear. Click Finish to complete the installation.

#### 4.2.4 Communication

Communicating via the USB interface is done using message strings. The message strings should be carefully formulated by the user program according to some simple rules to establish effective message flow control.

##### 4.2.4.1 Character Format

A character is the smallest piece of information that can be transmitted by the interface. Each character is ten bits long and contains data bits, character timing bits, and an error detection bit. The instrument uses 7 bits for data in the American Standard Code for Information Interchange (ASCII) format. One start bit and one stop bit are necessary to synchronize consecutive characters. Parity is a method of error detection. One parity bit configured for odd parity is included in each character.

ASCII letter and number characters are used most often as character data. Punctuation characters are used as delimiters to separate different commands or pieces of data. A special ASCII character, line feed (LF OAH), is used to indicate the end of a message string. This is called the message terminator.

##### 4.2.4.2 Message Strings

A message string is a group of characters assembled to perform an interface function. There are three types of message strings: commands, queries and responses. The computer issues command and query strings through user programs, the instrument issues responses. Two or more command or query strings can be chained together in one communication, but they must be separated by a semi-colon (;). The total communication string must not exceed 255 characters in length.

A command string is issued by the computer and instructs the instrument to perform a function or change a parameter setting. The format is:

```
<command mnemonic><space><parameter data><terminators>.
```

Command mnemonics and parameter data necessary for each one is described in section 4.3. Terminators must be sent with every message string.

A query string is issued by the computer and instructs the instrument to send a response. The query format is:

```
<query mnemonic><?><space><parameter data><terminators>.
```

Query mnemonics are often the same as commands with the addition of a question mark. Parameter data is often unnecessary when sending queries. Query mnemonics and parameter data if necessary is described in section 4.3. Terminators must be sent with every message string. The computer should expect a response very soon after a query is sent.

A response string is the instrument's response or answer to a query string. The response can be a reading value, status report or the present value of a parameter. Response data formats are listed along with the associated queries in section 4.3. The response is sent as soon as possible after the instrument receives the query.

#### 4.2.5 Message Flow Control

It is important to remember that the user program is in charge of the USB communication at all times. The instrument cannot initiate communication, determine which device should be transmitting at a given time, or guarantee timing between messages. All of this is the responsibility of the user program.

When issuing commands the user program alone should:

- Properly format and transmit the command including the terminator as one string
- Guarantee that no other communication is started for 50 ms after the last character is transmitted
- Not initiate communication more than 20 times per second

When issuing queries or queries and commands together, the user program should:

- Properly format and transmit the query including the terminator as one string
- Prepare to receive a response immediately
- Receive the entire response from the instrument including the terminator
- Guarantee that no other communication is started during the response or for 50 ms after it completes
- Not initiate communication more than 20 times per second

Failure to follow these simple rules will result in inability to establish communication with the instrument or intermittent failures in communication

### 4.3 Command Summary

This section provides a listing of the interface commands. A summary of all the commands is provided in TABLE 4-2. All the commands are detailed in section 4.3.1, and are presented in alphabetical order.

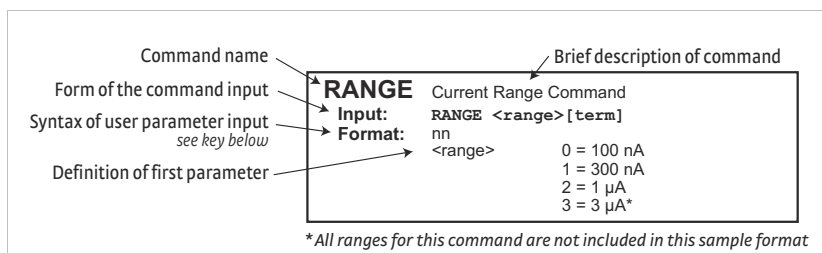

FIGURE 4-1 Sample command format

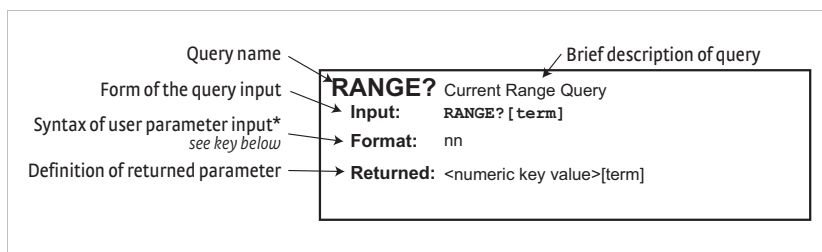

FIGURE 4-2 Sample query format

Command	Function	Page
*IDN?	Identification Query	page 31
*RST	Reset Instrument Command	page 31
BRIGT	Display Contrast Command	page 31
BRIGT?	Display Contrast Query	page 31
COMP?	Compliance Limit Query	page 31
DFLT	Factory Defaults Command	page 32
IENBL	Current Enable Command	page 32
IENBL?	Current Enable Query	page 32
IPOL	Polarity Command	page 32
IPOL?	Polarity Query	page 32
LOCK	Front Panel Keypad Lock Command	page 33
LOCK?	Front Panel Keypad Lock Query	page 33
RANGE	Output Range Command	page 33
RANGE?	Output Range Query	page 34
SETI	User Current Setting Command	page 34
SETI?	User Current Setting Query	page 34
SETSAVE	Power Up State	page 34

TABLE 4-2 *Command summary*

### 4.3.1 Interface Commands

This section lists the interface commands in alphabetical order.

<b>*</b>	Begins common interface command
<b>?</b>	Required to identify queries
<b>s[n]</b>	String of alphanumeric characters with length “n.” Send these strings using surrounding quotes. Quotes enable characters such as commas and spaces to be used without the instrument interpreting them as delimiters.
<b>nn...</b>	String of number characters that may include a decimal point.
<b>[term]</b>	Terminator characters
<b>&lt;...&gt;</b>	Indicated a parameter field, many are command specific.
<b>&lt;state&gt;</b>	Parameter field with only On/Off or Enable/Disable states.
<b>&lt;value&gt;</b>	Floating point values have varying resolution depending on the type of command or query issued.

TABLE 4-3 *Interface commands key*



---

<b>*IDN?</b>	<b>Identification Query</b>
Input	<b>*IDN?</b> [term]
Format	s[4],s[8],s[7],n.n <manufacturer>           Manufacturer ID <model>                    Instrument model number <instrument serial>       Instrument serial number <firmware version>       Instrument firmware version
Example	LSCI,MODEL121,1234567,1.0

---

<b>*RST</b>	<b>Reset Instrument Command</b>
Input	<b>*RST</b> [term]
Remarks	Sets instrument parameters to power-up settings.

---

<b>BRIGT</b>	<b>Display Brightness Command</b>
Input	<b>BRIGT</b> <display contrast> [term]
Format	nn <display brightness> 0–15
Remarks	Sets the display contrast for the front panel seven-segment display. A higher number makes the display brighter. The default setting is 8. The display can be turned off with setting the brightness to 0.

---

<b>BRIGT?</b>	<b>Display Brightness Query</b>
Input	<b>BRIGT?</b> [term]
Format	nn (refer to command for description)
Returned	<display brightness>[term]

---

<b>COMP?</b>	<b>Compliance Limit Query</b>
Input	<b>COMP?</b> [term]
Format	n
Returned	<compliance status> 0 = normal operation, 1 = in compliance limit
Remarks	Returns the voltage compliance limit status of the current source output

---

<b>DFLT</b>	<b>Factory Defaults Command</b>
Input	<code>DFLT 99 [term]</code>
Remarks	Sets all configuration values to factory defaults and resets the instrument. The “99” is included to prevent accidentally setting the unit to defaults.

---

<b>IENBL</b>	<b>Current Enable Command</b>
Input	<code>IENBL&lt;state&gt; [term]</code>
Format	n
	<state>                                    0 = disabled, 1 = enabled
Remarks	Allows for the current source output to be disabled or enabled

---

<b>IENBL?</b>	<b>Current Enable Query</b>
Input	<code>IENBL? [term]</code>
Format	n (refer to command for description)
Returned	<state>[term]

---

<b>IPOL</b>	<b>Polarity Command</b>
Input	<code>IPOL&lt;state&gt; [term]</code>
Format	n
	<state>                                    0 = positive, 1 = negative
Remarks	Allows for the polarity of the current to be changed. This does not affect the polarity of the user current setting.

---

<b>IPOL?</b>	<b>Polarity Query</b>
Input	<code>IPOL? [term]</code>
Format	n (refer to command for description)
Returned	<state>[term]
Remarks	Only valid for the fixed ranges, not the user current setting.

---

**LOCK** Front Panel Keypad Lock Command

**Input** LOCK<state> [term]  
**Format** n  
 <state> 0 = unlock, 1 = lock  
**Remarks** Allows for the user to lock or unlock the front panel keypad

---

**LOCK?** Front Panel Keypad Lock Query

**Input** LOCK? [term]  
**Format** n (refer to command for description)  
**Returned** <state>{term]

---

**PWUPENBL** Power Up Enable

**Input** PWUPENBL<state> [term]  
**Format** <state> 0 = disabled, 1 = enabled  
**Remarks** Specifies whether the output remains on or shuts off after power cycle.

---

**RANGE** Current Range Command

**Input** RANGE<range> [term]  
**Format** nn  
 <range> 0 = 100 nA  
 1 = 300 nA  
 2 = 1  $\mu$ A  
 3 = 3  $\mu$ A  
 4 = 10  $\mu$ A  
 5 = 30  $\mu$ A  
 6 = 100  $\mu$ A  
 7 = 300  $\mu$ A  
 8 = 1 mA  
 9 = 3 mA  
 10 = 10 mA  
 11 = 30 mA  
 12 = 100 mA  
 13 = User current

**Remarks** Allows the user to change the current range. Use the IPOL command to set the polarity.

---

**RANGE?** Current Range Query

Input `RANGE? [term]`  
 Format `nn`  
 Returned `<numeric key value>[term]`

---

**SETI** Set User Current Command

Input `SETI`  
 Format `±nnne-nn`  
`<user current value>` Current value as a three-digit number including a decimal place

Remarks User current is settable between 100 nA and 100 mA. The sign of the user current value determines the polarity of the output. The IPOL command does not affect this setting.

---

**SETI?** Set User Current Query

Input `SETI?`  
 Format `±nnn.nnne-nn`  
 Returned `<user current value>`  
 Remarks User current will be returned in engineering notation with three significant digits.

---

**SETSAVE** Power on Setup State

Input `SETSAVE`  
 Remarks The command saves the present range, polarity, and user current value. This saved state will be loaded on future power ups.

## Chapter 5: Options and Accessories

### 5.1 General

This chapter provides information on the models, options, and accessories available for the Model 121 current source.

### 5.2 Models

The list of Model 121 model numbers is provided in TABLE 5-1.

Model	Description of Models
121	Model 121 current source
121N	Model 121 current source with no power supply

TABLE 5-1 *Model description*

### 5.3 Accessories

Accessories are devices that perform a secondary duty as an aid or refinement to the primary unit. Refer to the Lake Shore Temperature Measurement and Control Catalog for details. A list of accessories available for the Model 121 is provided in TABLE 5-2.

Model	Description of Accessories
109-132*†	+5 V DC power supply, 100-240 V, 6 W power supply (universal input, changeable input plugs)
G-106-735	2-pin terminal block
MAN-121*	Model 121 current source manual
CAL-121-CERT	Instrument recalibration with certificate
CAL-121-DATA	Instrument recalibration with certificate and data.

\*Accessories included with a new Model 121

†Accessories not included with a new Model 121N

TABLE 5-2 *Accessories*



## Chapter 6: Service

### 6.1 General

This chapter provides basic service information for the Model 121 current source. Customer service of the product is limited to the information presented in this chapter. Factory trained service personnel should be consulted if the instrument requires repair.

### 6.2 USB Troubleshooting

This section provides USB interface troubleshooting for issues that arise with new installations, existing installations, and intermittent lockups.

#### 6.2.1 New Installation

1. Check that the instruments interface is set to USB.
2. Check that the USB driver is installed properly and that the device is functioning. In Microsoft Windows®, the device status can be checked using Device Manager by right-clicking **Lake Shore Model 121 Current Source** under **Ports (COM & LPT)** or **Other Devices** and then clicking **Properties**. Refer to section 4.2.3 for details on installing the USB driver.
3. Check that the correct com port is being used. In Microsoft Windows®, the com port number can be checked using Device Manager under **Ports (COM & LPT)**.
4. Check that the correct settings are being used for communication. Refer to section 4.2.3 for details on installing the USB driver.
5. Check cable connections and length.
6. Send the message terminator.
7. Send the entire message string at one time including the terminator. (Many terminal emulation programs do not.)
8. Send only one simple command at a time until communication is established.
9. Be sure to spell commands correctly and use proper syntax.

## 6.2.2 Existing Installation No Longer Working

1. Power the instrument off, then on again to see if it is a soft failure.
2. Power the computer off, then on again to see if communication port is locked up.
3. Check all cable connections.
4. Check that the com port assignment has not been changed. In Microsoft Windows®, the com port number can be checked using **Device Manager** under **Ports (COM & LPT)**.
5. Check that the USB driver is installed properly and that the device is functioning. In Microsoft Windows®, the device status can be checked using **Device Manager** by right-clicking **Lake Shore Model 121 Current Source** under **Ports (COM & LPT)** or **Other Devices** and then clicking **Properties**.

## 6.2.3 Intermittent Lockups

1. Check cable connections and length.
2. Increase the delay between all commands to 100 ms to make sure the instrument is not being overloaded.
3. Ensure that the USB cable is not unplugged and that the Model 121 is not powered down while the com port is open. The USB driver creates a com port when the USB connection is detected, and removes the com port when the USB connection is no longer detected. Removing the com port while in use by software can cause the software to lock up or crash.



## 6.3 Factory Reset

It is sometimes necessary to reset instrument parameter values that are stored in nonvolatile memory. Instrument calibration is not affected.

The factory defaults can be reset using by pressing ▲ and ▼ for three seconds. All of the LED digits will illuminate when the memory has been reset. Release the two keys and the display will return to normal operation.

Instrument configuration	Default
Current polarity	Positive
Current enable	Off
Pre-set current range	100 nA
User current	+100 nA
Display brightness	8
Keypad lock status	Unlock
Power up enable*	Off

*\* Available only in firmware release 1.3 or later.*

TABLE 6-1 Factory default settings

## 6.4 Product Information

Product information for your instrument is found by pressing +/- and ▲ for three seconds. This will display the firmware version. Any future key you press will exit this menu.

## 6.5 Error Messages

The following are error messages that may be displayed by the Model 121 during operation.

Message	Description
Err1	There is a hardware problem in the instrument memory. This error is not correctable by the user and the factory should be consulted. Refer to section 6.9.
Err2	There is a soft error in the instrument memory. This error can be corrected by reinitializing memory. Reinitializing memory sets the instrument to defaults. Refer to section 6.3.
Err3	The calibration memory is either corrupt, or is in the default, uncalibrated state. To continue with the instrument in an uncalibrated state, press ▲ and ▼ simultaneously.

TABLE 6-2 Error messages

## 6.6 Calibration Procedure

Instrument calibration can be obtained through Lake Shore Service. Refer to section 6.9 for technical inquiries and contact information.

## 6.7 Rear Panel Connector Definition

The terminal block, USB connector, and power supply connector are defined in FIGURE 6-1, FIGURE 6-2, and FIGURE 6-3.

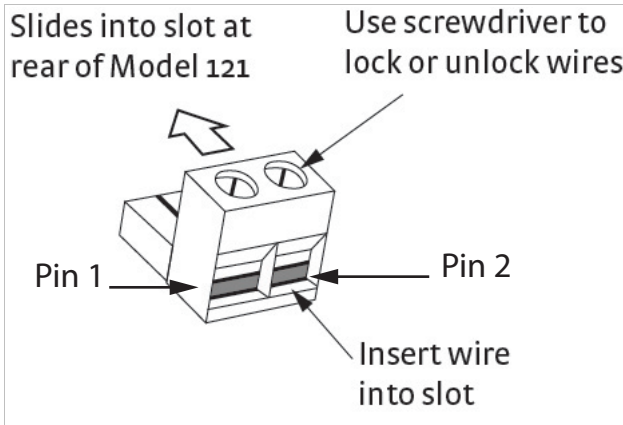

FIGURE 6-1 Terminal block for output of current source

Pin	Description
1	Current-
2	Current+

TABLE 6-3 Terminal block pin and connector details

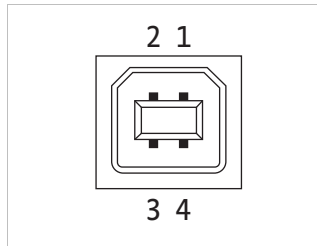

FIGURE 6-2 USB pin and connector details

Pin	Name	Description
1	VCC	+5 VDC
2	D-	Data-
3	D+	Data+
4	GND	Ground

TABLE 6-4 USB pin and connector details

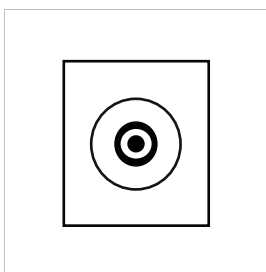

FIGURE 6-3 Power supply connector

Pin	Description
Inner conductor	+5 V
Outer conductor	Ground

TABLE 6-5 Power supply pin and connector details

## 6.8 Firmware Updates

This section provides instructions on updating your firmware. It also provides a table of the updates that have been made thus far.

### 6.8.1 Updating the Firmware

Periodically, Lake Shore provides updates to instrument firmware. The files for these updates can be downloaded from our website. To access the firmware updates, follow this procedure.

1. Go to 121 website page (<http://www.lakeshore.com/products/DC-Current-Sources/Model-121-DC-Current-Source/Pages/Overview.aspx>) to download the instrument firmware.
2. Enter your name and email address so that we can keep you updated on any new firmware for your instrument.
3. Click the “Go to the download” bar and follow the prompts that are provided on the screen for you.

### 6.8.2 Record of Updates Made to the Firmware

- 1.0 initial release.
- 1.1 minor bug fixes
- 1.2 minor bug fixes
- 1.3 added Power Up Enable feature

## 6.9 Technical Inquiries

Refer to the following sections when contacting Lake Shore for application assistance or product service. Questions regarding product applications, price, availability and shipments should be directed to sales. Questions regarding instrument calibration or repair should be directed to instrument service. Do not return a product to Lake Shore without a Return Material Authorization (RMA) number (section 6.9.2).

### 6.9.1 Contacting Lake Shore

The Lake Shore Service Department is staffed Monday through Friday between the hours of 8:00 AM and 5:00 PM EST, excluding holidays and company shut down days.

Contact Lake Shore Service through any of the means listed below. However, the most direct and efficient means of contacting is to complete the online service request form at <http://www.lakeshore.com/sup/serf.html>. Provide a detailed description of the problem and the required contact information. You will receive a response within 24 hours or the next business day in the event of weekends or holidays.

If you wish to contact Service or Sales by mail or telephone, use the following:

<b>Mailing address</b>	Lake Shore Cryotronics Instrument Service Department 575 McCorkle Blvd. Westerville, Ohio USA 43082-8888	
<b>E-mail address</b>	sales@lakeshore.com service@lakeshore.com	Sales Instrument Service
<b>Telephone</b>	614-891-2244 614-891-2243 select the option for service	Sales Instrument Service
<b>Fax</b>	614-818-1600 614-818-1609	Sales Instrument Service
<b>Web service request</b>	<a href="http://www.lakeshore.com/sup/serf.html">http://www.lakeshore.com/sup/serf.html</a>	Instrument Service

TABLE 8-6 *Contact information*

### 6.9.2 Return of Equipment

The temperature controller is packaged to protect it during shipment.



**The user should retain any shipping carton(s) in which equipment is originally received, in the event that any equipment needs to be returned.**

If the original packaging is not available, a minimum of 76.2 mm (3 in) of shock absorbent packing material should be placed snugly on all sides of the instrument in a sturdy corrugated cardboard box. Please use reasonable care when removing the temperature controller from its protective packaging and inspect it carefully for damage. If it shows any sign of damage, please file a claim with the carrier immediately. Do not destroy the shipping container; it will be required by the carrier as evidence to support claims. Call Lake Shore for return and repair instructions.

All equipment returns must be approved by a member of the Lake Shore Service Department. The service engineer will use the information provided in the service request form and will issue an RMA. This number is necessary for all returned equipment. It must be clearly indicated on both the shipping carton(s) and any correspondence relating to the shipment. Once the RMA has been approved, you will receive appropriate documents and instructions for shipping the equipment to Lake Shore.

### 6.9.3 RMA Valid Period

RMAs are valid for 60 days from issuance; however, we suggest that equipment needing repair be shipped to Lake Shore within 30 days after the RMA has been issued. You will be contacted if we do not receive the equipment within 30 days after the RMA is issued. The RMA will be canceled if we do not receive the equipment after 60 days.

### 6.9.4 Shipping Charges

All shipments to Lake Shore are to be made prepaid by the customer. Equipment serviced under warranty will be returned prepaid by Lake Shore. Equipment serviced out-of-warranty will be returned FOB Lake Shore.

### 6.9.5 Restocking Fee

Lake Shore reserves the right to charge a restocking fee for items returned for exchange or reimbursement.



# Appendix A: Handling Liquid Helium and Nitrogen

## A.1 General

Use of liquid helium (LHe) and liquid nitrogen (LN<sub>2</sub>) is often associated with the Model 121 current source. Although not explosive, there are a number of safety considerations to keep in mind in the handling of LHe and LN<sub>2</sub>.

## A.2 Properties

LHe and LN<sub>2</sub> are colorless, odorless, and tasteless gases. Gaseous nitrogen makes up about 78 percent of the Earth's atmosphere, while helium comprises only about 5 ppm. Most helium is recovered from natural gas deposits. Once collected and isolated, the gases will liquefy when properly cooled. A quick comparison between LHe and LN<sub>2</sub> is provided in TABLE A-1.

Property	Liquid Helium	Liquid Nitrogen
Boiling Point at 1 atm	4.2 K	77 K
Thermal Conductivity (Gas), w/cm-K	0.083	0.013
Latent Heat of Vaporization, Btu/L	2.4	152
Liquid Density, lb/L	0.275	0.78

TABLE A-1 Comparison of liquid helium and liquid nitrogen

### A.3 Handling Cryogenic Storage Dewars

Cryogenic containers (Dewars) must be operated in accordance with the manufacturer instructions. Safety instructions will also be posted on the side of each Dewar. Cryogenic Dewars must be kept in a well-ventilated place where they are protected from the weather and away from any sources of heat. A typical cryogenic Dewar is shown in FIGURE A-1.

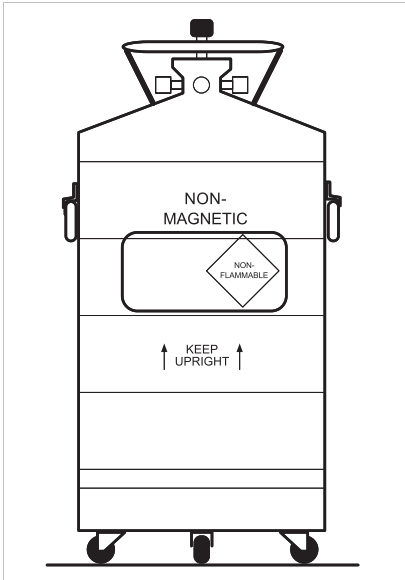

FIGURE A-1 Typical cryogenic storage Dewar

### A.4 Liquid Helium and Nitrogen Safety Precautions

Transferring LHe and LN<sub>2</sub> and operation of the storage Dewar controls should be in accordance with the manufacturer/supplier's instructions. During this transfer, it is important that all safety precautions written on the storage Dewar and recommended by the manufacturer be followed.



**⚠ WARNING**

Liquid helium and liquid nitrogen are potential asphyxiants and can cause rapid suffocation without warning. Store and use in area with adequate ventilation. **DO NOT** vent container in confined spaces. **DO NOT** enter confined spaces where gas may be present unless area has been well ventilated. If inhaled, remove to fresh air. If not breathing, give artificial respiration. If breathing is difficult, give oxygen. Get medical help.

**⚠ WARNING**

Liquid helium and liquid nitrogen can cause severe frostbite to the eyes or skin. **DO NOT** touch frosted pipes or valves. In case of frostbite, consult a physician at once. If a physician is not readily available, warm the affected areas with water that is near body temperature.

The two most important safety aspects to consider when handling LHe and LN<sub>2</sub> are adequate ventilation and eye and skin protection. Although helium and nitrogen gases are non-toxic, they are dangerous in that they replace the air in a normal breathing atmosphere. Liquid products are of an even greater threat since a small amount of liquid evaporates to create a large amount of gas. Therefore, it is imperative that cryogenic Dewars be stored and the MTD system be operated in open and well ventilated areas.

Persons transferring LHe and LN<sub>2</sub> should make every effort to protect eyes and skin from accidental contact with liquid or the cold gas issuing from it. Protect your eyes with full-face shield or chemical splash goggles. Safety glasses (even with side shields) are not adequate. Always wear special cryogenic gloves (Tempshield Cryo-Gloves® or equivalent) when handling anything that is, or may have been, in contact with the liquid or cold gas, or with cold pipes or equipment. Long sleeve shirts and cuffless trousers that are of sufficient length to prevent liquid from entering the shoes are recommended.

## A.5 Recommended First Aid

Every site that stores and uses LHe and LN2 should have an appropriate Material Safety Data Sheet (MSDS) present. The MSDS may be obtained from the manufacturer/distributor. The MSDS will specify the symptoms of overexposure and the first aid to be used. A typical summary of these instructions is provided as follows.

If symptoms of asphyxia such as headache, drowsiness, dizziness, excitation, excess salivation, vomiting, or unconsciousness are observed, remove the victim to fresh air. If breathing is difficult, give oxygen. If breathing has stopped, give artificial respiration. Call a physician immediately.

If exposure to cryogenic liquids or cold gases occurs, restore tissue to normal body temperature (98.6 °F) as rapidly as possible, then protect the injured tissue from further damage and infection. Call a physician immediately. Rapid warming of the affected parts is best achieved by bathing it in warm water. The water temperature should not exceed 105 °F (40 °C), and under no circumstances should the frozen part be rubbed, either before or after rewarming. If the eyes are involved, flush them thoroughly with warm water for at least 15 minutes. In case of massive exposure, remove clothing while showering with warm water. The patient should not drink alcohol or smoke. Keep warm and rest. Call a physician immediately.

## Appendix B: Regulatory Declarations

### **B.1 General**

Declarations in this appendix apply to the Lake Shore Cryotronics Model 121 programmable DC current source beginning with serial number 121000A and subsequent, as well as its power supply. Paragraph B1.1 refers to the CE declaration for the Model 121 alone. Paragraphs B1.2 through B1.5 refer to the CE and RoHS declarations respectively for the unit's power supply.

The declarations included are as follows:

- CE declaration for the Model 121
- CE declaration for the power supply, P/N 109-132
- RoHS declaration for the power supply, P/N 109-132

## B.1.1 CE Declaration for Model 121



### EU DECLARATION OF CONFORMITY



This declaration of conformity is issued under the sole responsibility of the manufacturer.

**Manufacturer:**

Lake Shore Cryotronics, Inc.  
575 McCorkle Boulevard  
Westerville, OH 43082  
USA

**Object of the declaration:**

**Model(s):** 121  
**Description:** Programmable DC Current Source

The object of the declaration described above is in conformity with the relevant Union harmonization legislation:

2014/30/EU EMC Directive  
2011/65/EU RoHS

References to the relevant harmonized standards used to the specification in relation to which conformity is declared:

EN 61326-1:2013  
Class A  
Controlled Electromagnetic Environment

EN 50581:2012

**Signed for and on behalf of:**

**Place, Date:**  
Westerville, OH, USA  
29-SEP-2016

A handwritten signature in blue ink, appearing to read "Scott Ayer", written over a horizontal line.

Scott Ayer  
Director of Quality & Compliance

## B.1.2 CE Declaration for the Power Supply, Part Number 109-132



### EC – Declaration of Conformity

For the following equipment:

Switching Power Supply

**Series Number: SMI6**

Imported By:

**CUI Inc**  
**20050 SW 112<sup>th</sup> Ave**  
**Tualatin, OR 97062**

Is herewith confirmed to comply with the requirements set out in the Council Directive on the Approximation of the Laws of Member States relating to the Electromagnetic Compatibility Directive 2014/30/EU, Low Voltage Directive 2014/35/EU, RoHS Directive 2011/65/EU, and WEEE Directive 2012/19/EU. For the evaluation regarding the Electromagnetic Compatibility 2014/30/EU, Low Voltage Directive 2014/35/EU, RoHS Directive 2011/65/EU, and WEEE directive 2012/19/EU, the following standards are applied:

**EN 55022:2011+AC:2011, Class B**  
**EN 55024:2010**  
**EN 61204-3:2000, Class B**  
**IEC 61000-4 Series**  
**EN 61000-3-2:2014**  
**EN 61000-3-3:2013**  
**EN 60950-1:2006+A11:2009+A1:2010+A12:2011+A2:2013**  
**IEC 60950-1:2005 (2<sup>nd</sup> Edition); Am 1:2009+Am 2:2013**

A handwritten signature in black ink, appearing to read "Ryan Smoot", written over a horizontal line.

**Ryan Smoot**  
Technical Support Engineer  
CUI Inc.  
May 17, 2016

