

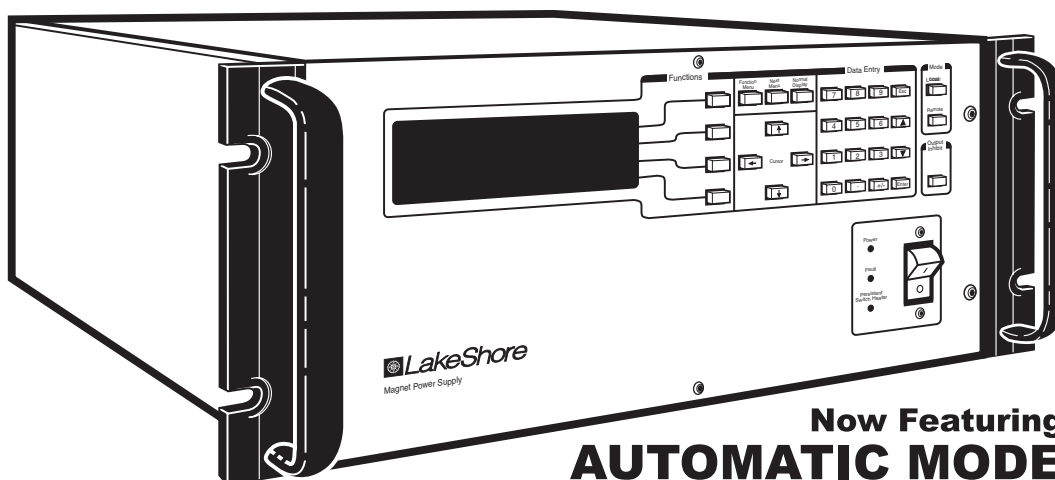

User's Manual

Model 620/622/623/647

Magnet Power Supply



Model 620 – ± 50 A, ± 5 V
Model 622 – ± 125 A, ± 30 V

Model 623 – ± 155 A, ± 30 V
Model 647 – ± 72 A, ± 32 V



Lake Shore Cryotronics, Inc.
575 McCorkle Blvd.
Westerville, Ohio 43082-8888 USA

E-Mail Addresses:
sales@lakeshore.com
service@lakeshore.com

Visit Our Website:
www.lakeshore.com

Fax: (614) 891-1392
Telephone: (614) 891-2243

Methods and apparatus disclosed and described herein have been developed solely on company funds of Lake Shore Cryotronics, Inc. No government or other contractual support or relationship whatsoever has existed which in any way affects or mitigates proprietary rights of Lake Shore Cryotronics, Inc. in these developments. Methods and apparatus disclosed herein may be subject to U.S. Patents existing or applied for. Lake Shore Cryotronics, Inc. reserves the right to add, improve, modify, or withdraw functions, design modifications, or products at any time without notice. Lake Shore shall not be liable for errors contained herein or for incidental or consequential damages in connection with furnishing, performance, or use of this material.

LIMITED WARRANTY

Lake Shore Cryotronics, Inc. (henceforth Lake Shore), the manufacturer, warrants the instrument to be free from defects in material and workmanship for a period of twelve months from the date of shipment. During the warranty period, under authorized return of instruments or component parts to Lake Shore freight prepaid, the company will repair, or at its option replace, any part found to be defective in material or workmanship, without charge to the Owner for parts, service labor or associated customary shipping cost. Replacement or repaired parts will be warranted for only the unexpired portion of the original warranty.

All products are thoroughly tested and calibrated to published specifications prior to shipment. Calibration Certifications are offered for six month periods only. Where such documentation must be updated, a re-certification service is offered by Lake Shore at a reasonable cost.

LIMITATION OF WARRANTY

This warranty is limited to Lake Shore products purchased and installed in the United States, or Internationally through our approved distribution agents. This same protection will extend to any subsequent owner during the warranty period. It does not apply to damage resulting from improper or inadequate maintenance, unauthorized modification or misuse, operation outside of the environmental specifications, or from buyer-supplied software interfacing. It does not apply to damage caused by accident, misuse, fire, flood or Acts of God, or from failure to properly install, operate, or maintain the product in accordance with the printed instruction provided.

This warranty is in lieu of any other warranties, expressed or implied, including merchantability or fitness for a particular purpose, which are expressly excluded. The owner agrees that Lake Shore's liability with respect to this product shall be set forth in this warranty, and incidental or consequential damages are expressly excluded.

CERTIFICATION

Lake Shore certifies that this product has been inspected and tested in accordance with its published specifications and that this product met its published specifications at the time of shipment. The accuracy and calibration of this product at the time of shipment are traceable to the United States National Institute of Standards and Technology (NIST); formerly known as the National Bureau of Standards (NBS), or to a recognized natural standard.

TRADEMARK ACKNOWLEDGMENT

Many manufacturers and sellers claim designations as trademarks to distinguish their products. Where those designations appear in this manual and Lake Shore was aware of a trademark claim, they appear with initial capital letters and a proceeding [™] or [®] symbol.

CalCurve[™], Carbon-Glass[™], Cernox[™], Duo-Twist[™], Gamma Probe[™], Quad-Lead[™],
and Quad-Twist[™] are trademarks of Lake Shore Cryotronics, Inc.

Kapton[®] is a trademark of 3M.

Stycast[®] is a trademark of Emerson & Cuming.

Teflon[®] is a trademark of DuPont De Nemours.

QuickBasic[®] is a trademark of Microsoft Corporation.

Copyright © 1995 – 1999 by Lake Shore Cryotronics, Inc. All rights reserved. No portion of this manual may be reproduced, stored in a retrieval system, or transmitted, in any form or by any means, electronic, mechanical, photocopying, recording, or otherwise, without the express written permission of Lake Shore.

TABLE OF CONTENTS

<i>Chapter/Paragraph</i>	<i>Title</i>	<i>Page</i>
	List of Illustrations	iv
	List of Tables	iv
	Foreword	v
	Purpose and Scope	v
	Hardware Covered	v
	Warnings, Cautions, and Notes	v
	General Installation Precautions	v
	Electrostatic Discharge	v
	Handling Electrostatic Discharge Sensitive Components	vi
	Safe Handling of Liquid Cryogenes	vi
	Magnet Quenches	vi
	Dangerous Voltages	vi
	Before You Operate the Equipment	vii
	Safety Summary	vii
	Safety Symbols	viii
1	INTRODUCTION	1-1
1.0	General	1-1
1.1	Features	1-1
1.2	Specifications	1-2
1.3	Operating Characteristics	1-4
1.3.1	True, Four-Quadrant Bidirectional Power Flow	1-4
1.3.2	Low Noise, High Stability Current Regulated Output	1-5
1.3.3	Highly Efficient, Air-Cooled, Compact Unit	1-5
2	INITIAL SETUP AND CONNECTIONS	2-1
2.1	Inspecting and Unpacking	2-1
2.2	MPS Mounting	2-1
2.3	Environmental Requirements	2-1
2.4	Connecting the MPS to Power	2-1
2.4.1	Power and Ground Requirements	2-2
2.4.2	MPS Input Power Ratings	2-2
2.4.3	Input Power Connections	2-2
2.5	Power Up	2-3
2.5.1	Magnet Cable Connections	2-3
2.5.2	Shielding, Grounding, and Noise	2-4
2.5.3	MPS Remote Inhibit and Fault Indicator Connections	2-4
2.5.4	AC On Indicator	2-4
2.5.5	OVP Connection	2-4
2.5.6	MPS Analog Current and Voltage Monitoring Connections	2-5
2.5.7	External Current Programming	2-5
2.5.8	Remote Sense Connections	2-5
2.6	Multiple Auto-Parallel Setup	2-6
2.6.1	Multiple MPS Remote Inhibit Mode	2-8
2.7	Post-Installation Instructions	2-9
2.8	System Shutdown and Repackaging for Storage or Shipment	2-9
2.9	Returning Equipment to Lake Shore	2-9
3	OPERATION	3-1
3.0	General	3-1
3.1	The MPS Front Panel	3-1
3.2	Power UP	3-2

TABLE OF CONTENTS (Continued)

<i>Chapter/Paragraph</i>	<i>Title</i>	<i>Page</i>
3.3	Normal Display for Manual Mode	3-2
3.4	Normal Display for Manual PSH Control	3-3
3.5	Normal Display for Automatic PSH Control	3-3
3.6	Function Menus	3-5
3.6.1	Function Menu 1	3-5
3.6.1.1	Automatic Mode / Manual Mode	3-5
3.6.1.2	Interface Setup Screen	3-5
3.6.1.3	Step Limit/Zero Screen	3-6
3.6.1.4	Instrument Setup Screen	3-6
3.6.2	Function Menu 2	3-7
3.6.2.1	Outputs Only Screen	3-8
3.6.2.2	LHe Level	3-8
3.6.2.3	Field	3-8
3.6.2.4	PSH Setup	3-8
3.6.3	Function Menu 3	3-8
3.6.3.1	Delays Setup Screen	3-8
3.6.3.2	Delays Setup Screen with Dithering	3-9
3.7	Manual Persistence Control Example	3-9
3.8	Automatic Persistence Control Example	3-9
3.9	Dithering in Automatic Mode	3-11
4	REMOTE OPERATION	4-1
4.0	General	4-1
4.1	IEEE-488 Interface	4-1
4.1.1	IEEE-488 Interface Settings	4-1
4.1.2	IEEE-488 Command Structure	4-2
4.1.2.1	Bus Control Commands	4-2
4.1.2.2	Common Commands	4-2
4.1.2.3	Interface and Device Specific Commands	4-2
4.1.3	Status Registers	4-2
4.1.3.1	Status Byte and Service Request Enable Registers	4-3
4.1.3.2	Standard Event and Standard Event Status Registers	4-3
4.1.4	Example IEEE Setup and Program	4-4
4.1.4.1	GPIB Board Installation	4-4
4.1.4.2	Run the Example QuickBasic Program	4-4
4.1.5	Notes On Using the IEEE Interface	4-5
4.2	Serial I/O Interface	4-7
4.2.1	Serial Interface Hardware Configuration	4-8
4.2.2	Serial Interface Settings	4-8
4.2.3	Sample BASIC Serial Interface Program	4-8
4.2.4	Notes on Using the Serial Interface	4-9
4.3	Summary of IEEE-488/Serial Interface Commands	4-10
4.3.1	Operational Commands Description	4-11
4.3.2	Interface Commands Description	4-13
4.3.3	Ramping Commands Description	4-14
4.3.4	Current Zero Commands Description	4-15
4.3.5	Current Step Limit Commands Description	4-16
4.3.6	Computed Field Commands Description	4-17
4.3.7	Common Commands Description	4-18

TABLE OF CONTENTS (Continued)

<i>Chapter/Paragraph</i>	<i>Title</i>	<i>Page</i>
5	ERROR MESSAGES AND TROUBLESHOOTING	5-1
5.0	General	5-1
5.1	Software Error Messages	5-1
5.2	Factory Default Settings	5-4
5.3	Calibration	5-5
5.4	Performance Test	5-6
5.5	Rear Panel Connector Details	5-8
5.6	IEEE-488 Interface Connector	5-9
5.7	Serial Interface Cable and Adapters	5-9
6	OPTIONS AND ACCESSORIES	6-1
6.0	General	6-1
6.1	Model 6224 IEEE-488/Serial Interface	6-1
6.2	Model 6226/6476 Liquid Helium Level and Gaussmeter Input Card	6-1
6.2.1	Hall Sensor Mounting Considerations - Models HGCT-3020 and HGCA-3020	6-2
6.2.2	The Model MSA-410 and MST-410 Hall Sensors	6-3
6.2.3	Connections	6-3
6.2.4	Installation	6-3
6.2.5	LHe Level	6-4
6.2.5.1	LHe Level Operation	6-4
6.2.5.2	Field Probe Setting and Calibration	6-5
6.2.6	Level Sensor Calibration	6-5
6.2.7	Model 6226/6476 IEEE-488 Remote Operation Commands	6-6
6.3	Model 6228 and 6228-8MUX Persistent Switch Heater Output	6-9
6.3.1	Installation	6-9
6.3.2	Model 6228 Operation	6-9
6.3.3	Model 6228-8MUX Operation	6-10
6.3.4	PSH Card Voltage Constraints	6-10
6.3.5	Model 6228 Remote Operation Commands	6-11
6.4	Model 6228-2 Persistent Switch Heater Output	6-12
6.4.1	Model 6228-2 Remote Operation Commands	6-13
6.5	Accessories	6-14
APPENDIX A – UNITS FOR MAGNETIC PROPERTIES		A-1
APPENDIX B – MAINFRAME REMOTE OPERATION		B-1
B1.0	General	B-1
B2.0	Control Bus Serial Interface Specifications	B-1
B3.0	Control Bus Serial Interface Connector	B-1
B4.0	Control Bus Serial Interface Configuration	B-2
B5.0	Selecting the Control Bus Serial Interface Address	B-2
B6.0	Control Bus Serial Interface Operation	B-3
B7.0	Control Bus Serial Interface Sample Program	B-4

LIST OF ILLUSTRATIONS

Figure No.	Title	Page
1-1	Four-Quadrant Power	1-4
1-2	Comparison of Old and New MPS Designs	1-5
2-1	RI, FLT, ON, and OVP Connections	2-4
2-2	Analog Monitoring, Programming, & Remote Sense Connections	2-5
2-3	Remote Sensing Connections.....	2-6
2-4	Typical Multiple MPS Connections for Two MPS Units.....	2-8
3-1	MPS Front Panel.....	3-1
3-2	Typical Automatic Mode Cycle	3-10
4-1	Typical National Instruments GPIB Configuration from IBCONF.EXE.....	4-6
4-2	Serial Interface Adapters.....	4-7
5-1	Rear Panel Connectors.....	5-8
5-2	Serial Interface Connector	5-8
5-3	IEEE-488 Connector	5-9
5-4	Model 2001 RJ-11 Cable Assembly Wiring	5-9
5-5	Model 2002 RJ-11 to DB-9 Adapter Wiring.....	5-9
5-6	Model 2003 RJ-11 to DB-25 Adapter Wiring.....	5-9
6-1	NbTi Filament Resistance Chart.....	6-6

LIST OF TABLES

Table No.	Title	Page
1-1	Model 620/622/623 Input Current	1-3
1-2	Model 647 Input Current	1-3
1-3	Model 620/622/623 DC Output Specifications	1-3
1-4	Model 647 DC Output Specifications	1-3
2-1	Load Wire Lengths and Current Capacity.....	2-3
2-2	RI, FLT, ON, and OVP Connections	2-4
2-3	Analog Monitoring, Programming, and Remote Sense Connections.....	2-5
2-4	Connections for a Two-MPS Autoparallel Configuration.....	2-7
4-1	Sample Basic IEEE-488 Interface Program.....	4-5
4-2	Serial Interface Specifications.....	4-8
4-3	Sample Basic Serial Interface Program	4-9
5-1A	Rear Panel Connector Definitions.....	5-8
5-1B	Rear Panel CAL AND ID Switch Definitions.....	5-8
5-2	Serial Interface Connector Definition	5-8
5-3	IEEE-488 Interface Connector Definition	5-9
6-1	Model 6226/6476 Connections	6-3
6-2	NbTi Filament Resistance Values.....	6-6
A-1	Units for Magnetic Properties.....	A-1
B-1	MPS Mainframe Control Bus Remote Command Summary.....	B-5
B-2	Additional MPS Mainframe Control Bus Remote Commands	B-6

FOREWORD

PURPOSE AND SCOPE

This manual contains user instructions for the Model 620/622/623/647 Magnet Power Supply (MPS). Lake Shore Cryotronics, Inc. designed, manufactures, and assembles the MPS in the United States of America.

We welcome your comments concerning this manual. Although every effort has been made to keep it free of errors, some may occur. To report a specific problem, please describe it briefly and include the manual title, revision number, date, the paragraph/figure/table number, and the page number. Send comments to Lake Shore Cryotronics, Inc. Attn: Technical Publications, 575 McCorkle Blvd., Westerville, Ohio 43082-8888.

HARDWARE COVERED

The MPS is available in the following configurations:

Model 620: ± 50 A, ± 5 V, 250 VA	Model 623: ± 155 A, ± 30 V, 1 kVA
Model 622: ± 125 A, ± 30 V, 1 kVA	Model 647: ± 72 A, ± 32 V, 2 kVA

Page A of this manual (following the title page) details the options installed in your unit. See Chapter 6 for detailed definitions of hardware configurations.

WARNINGS, CAUTIONS, AND NOTES

Warnings, cautions, and notes appear throughout this manual and precede the step to which they pertain. Multiple warnings, cautions, or notes are bulleted.

WARNING: An operation or maintenance procedure which, if not strictly observed, may result in injury, death, or long-term health hazards to personnel.

CAUTION: An operation or maintenance procedure which, if not strictly observed, may result in equipment damage, destruction, or loss of effectiveness.

NOTE: Emphasizes an operation or maintenance procedure.

GENERAL INSTALLATION PRECAUTIONS

These recommended general safety precautions are unrelated to any specific procedure and do not appear elsewhere in this manual. Personnel should understand and apply these precautions during installation.

Installation personnel shall observe all safety regulations at all times. Keep away from live circuits. Turn off system power before making or breaking electrical connections. Regard any exposed connector, terminal board, or circuit board as a possible shock hazard. Discharge charged components only when such grounding cannot damage equipment. If a test connection to energized equipment is required, make the test equipment ground connection before probing the voltage or signal.

Do not install or service equipment alone. Do not under any circumstances reach into or enter any enclosure to service or adjust equipment without the presence or assistance of another person able to render aid.

ELECTROSTATIC DISCHARGE

Electrostatic Discharge (ESD) may damage electronic parts, assemblies, and equipment. ESD is a transfer of electrostatic charge between bodies at different electrostatic potentials caused by direct contact or induced by an electrostatic field. The low-energy source that most commonly destroys Electrostatic Discharge Sensitive (ESDS) devices is the human body, which generates and retains static electricity. Simply walking across a carpet in low humidity may generate up to 35,000 volts of static electricity.

Current technology trends toward greater complexity, increased packaging density, and thinner dielectrics between active elements, which results in electronic devices with even more ESD sensitivity. Some electronic parts are more ESDS than others. ESD levels of only a few hundred volts may damage electronic components such as semiconductors, thick and thin film resistors, and piezoelectric crystals during testing, handling, repair, or assembly. Discharge voltages below 4000 volts cannot be seen, felt, or heard.

Identification of Electrostatic Discharge Sensitive Components

Below are various industry symbols used to label components as ESDS:



HANDLING ELECTROSTATIC DISCHARGE SENSITIVE COMPONENTS

Observe all precautions necessary to prevent damage to ESDS components before attempting installation. Bring the device and everything that contacts it to ground potential by providing a conductive surface and discharge paths. As a minimum, observe these precautions:

1. De-energize or disconnect all power and signal sources and loads used with unit.
2. Place unit on a grounded conductive work surface.
3. Ground technician through a conductive wrist strap (or other device) using 1 M Ω series resistor to protect operator.
4. Ground any tools, such as soldering equipment, that will contact unit. Contact with operator's hands provides a sufficient ground for tools that are otherwise electrically isolated.
5. Place ESDS devices and assemblies removed from a unit on a conductive work surface or in a conductive container. An operator inserting or removing a device or assembly from a container must maintain contact with a conductive portion of the container. Use only plastic bags approved for storage of ESD material.
6. Do not handle ESDS devices unnecessarily or remove them from their packages until actually used or tested.

SAFE HANDLING OF LIQUID CRYOGENS

Two essential safety aspects of handling LHe are adequate ventilation and eye and skin protection. Although helium gas is non-toxic, it is dangerous because it replaces air in a normal breathing atmosphere. Liquid helium is an even greater threat because a small amount of liquid evaporates to create a large amount of gas. Store and operate cryogenic dewars in open, well-ventilated areas.

WARNING

- **Liquid helium is a potential asphyxiant and can cause rapid suffocation without warning. Store and use in an adequately ventilated area. DO NOT vent the container in confined spaces. DO NOT enter confined spaces where gas may be present unless area is well-ventilated. If inhaled, remove to fresh air. If not breathing, give artificial respiration. If breathing is difficult, give oxygen. Get medical attention.**
- **Liquid helium can cause severe frostbite to exposed body parts. DO NOT touch frosted pipes or valves. For frostbite, consult a physician immediately. If a physician is unavailable, warm the affected parts with water that is near body temperature.**

MAGNET QUENCHES

For protection during a magnet quench, fit the dewar with pressure relief valves of sufficient size and pressure rating to allow the helium gas to escape and to prevent excessive pressure in the dewar. Operating a magnet in a dewar without proper pressure relief is dangerous and possibly life-threatening. The magnet may transfer tremendous energy to the cryogen during a quench. Consult both the magnet and dewar manufacturers to check pressure relief valve sufficiency.

DANGEROUS VOLTAGES

High voltages are present inside the MPS. Never attempt to service the MPS. Refer all service to qualified personnel. There are no user-serviceable parts inside the MPS.

The MPS current output terminals may be dangerous. Although MPS output voltage is limited to ± 40 VDC, a catastrophic failure inside the MPS could pass lethal voltages to the output terminals. Do not touch the terminals during MPS operation.

BEFORE YOU OPERATE THE EQUIPMENT

Train personnel in proper emergency measures such as electrical power shut off, fire department notification, fire extinguishing, and personnel and records evacuation. Here is a list of suggested personnel safety considerations:

- Ground Fault Interrupter (GFI) AC circuits
- Fire Extinguisher
- Magnetic Field Warnings
- Emergency Lighting

Locate in the immediate vicinity fire extinguisher(s) that extinguish all three classes of fires: A, B, and C. Class A is ordinary combustibles like wood, paper, rubber, many plastics, and other common materials that burn easily. Class B is flammable liquids like gasoline, oil, and grease. Class C is energized electrical equipment including wiring fuse boxes, circuit breakers, machinery, and appliances. Do not use chemical extinguishers even though they are less expensive and cover all classes of fires. They may damage electronic equipment. Use a Carbon Dioxide or Halon fire extinguisher.

During the planning stage, consult local experts, building authorities, and insurance underwriters on locating and installing sprinkler heads, fire and smoke sensing devices, and other fire extinguishing equipment.

Even where not required by code, install some type of automatic, battery-operated emergency lighting in case of power failure or fire.

SAFETY SUMMARY

Observe the following general safety precautions during all phases of operation, service, and repair of this instrument. Failure to comply with these precautions or with specific warnings elsewhere in this manual violates safety standards of design, manufacture, and intended use of the instrument. Lake Shore Cryotronics, Inc. assumes no liability for the customer's failure to comply with these requirements.

Ground the Instrument

To minimize shock hazard, connect the instrument chassis and cabinet to an electrical ground. The instrument is equipped with a three-conductor AC power cable. Plug this cable into either an approved three-contact electrical outlet or a three-contact adapter with the grounding wire (green) firmly connected to an electrical ground (safety ground) at the power outlet. The power jack and mating plug of the power cable meet Underwriters Laboratories (UL) and International Electrotechnical Commission (IEC) safety standards.

Do Not Operate in an Explosive Atmosphere

Do not operate the instrument in the presence of flammable gases or fumes. Operating any electrical instrument in such an environment constitutes a definite safety hazard.

Keep Away from Live Circuits

Operating personnel must not remove instrument covers. Refer component replacement and internal adjustments to qualified maintenance personnel. Do not replace components with power cable connected. To avoid injuries, always disconnect power and discharge circuits before touching them.









Do Not Substitute Parts or Modify Instrument

Do not install substitute parts or perform any unauthorized modification to the instrument. Return the instrument to an authorized Lake Shore Cryotronics, Inc. representative for service and repair to ensure that safety features are maintained.

Dangerous Procedure Warnings

A WARNING heading precedes potentially dangerous procedures throughout this manual. Instructions in the warnings *must* be followed.

SAFETY SYMBOLS

	Direct current (power line).
	Alternating current (power line).
	Alternating or direct current (power line).
	Three-phase alternating current (power line).
	Earth (ground) terminal.
	Protective conductor terminal.
	Frame or chassis terminal.
	On (supply)
	Off (supply)

 Equipment protected throughout by double insulation or reinforced insulation (equivalent to Class II of IEC 536 - see annex H).

 Caution: High voltages; danger of electric shock. Background color: Yellow; Symbol and outline: Black.

 Caution or Warning - See instrument documentation. Background color: Yellow; Symbol and outline: Black.

CHAPTER 1

INTRODUCTION

1.0 GENERAL

This chapter covers Features (Paragraph 1.1), Specifications (Paragraph 1.2), and Operating Characteristics (Paragraph 1.3).

1.1 FEATURES

- **True, Four-Quadrant Bidirectional Power Flow:** Operate current or voltage as a source or a sink in either positive or negative polarities. Sink power returns to the AC line instead of dissipating through an energy absorber.
- **Low Noise, High Stability Current Regulation:** Analog output control uses a precision shunt for current stabilization to better than 50 PPM of full-scale current over an 8-hour period.
- **± 50 A, ± 5 V (Model 620), ± 125 A, ± 30 V (Model 622), ± 155 A, ± 30 V (Model 623), or ± 72 A, ± 32 V (Model 647), Constant Current Output:**
 1. Programming resolution for Models 620/622/647 is 1.0 mA and 1 mV.
 2. Programming resolution for the Model 623 is 1.2 mA and 1 mV.
- **No current reversal switch required:** Output current reversal is smooth and continuous with excellent near zero current performance.
- **Remote and local sensing of output voltage:** Compensates for voltage drops in the output leads.
- **Quiet switched-mode design:** Results in a highly efficient, lightweight unit capable of air cooling.
- **Front Panel Graphic Display:** Allows continuous display of output while setting parameters from the menu-driven keypad. Operating parameters that can be set and monitored are:
 1. Output current and compliance setting.
 2. Output current and voltage measurement.
 3. Output current step limiting.
 4. Output current zeroing.
 5. Output ramp programming.
 6. Status reporting.
 7. Persistent switch heater control (with optional Model 6228 Card).
 8. Liquid Helium level and Field monitoring (with optional Model 6226/6476 Card).
- **Four methods of setting and monitoring all operating parameters:**
 1. From front panel.
 2. From remote interfaces.
 3. Through analog inputs and outputs.
 4. Through optional Lake Shore MPS Driver Software.
- **Automatic Mode:** Easily controls Superconducting Magnets using the Model 6228 Persistent Switch Heater Option Card.
- **IEEE-488 Interface Option**
- **Model 6226/6476 Liquid Helium Level/Gaussmeter Input Option Card**
- **Model 6228 Persistent Switch Heater Option Card**
- **Protection:** Overvoltage/Quench protection circuits which limit or turn off the MPS output, or turn off the input in the event of an abnormal condition; current step limit exceeded; internal overtemperature; AC line loss detection; remote inhibit; output power exceeded. Front panel annunciators, an audio alarm, and a contact closure indicate faults.

1.2 SPECIFICATIONS

Below are performance specifications for current with a 1 Henry load and voltage with a resistive load.

DC Output: True, Four-Quadrant, Bidirectional Power Flow output. Autoranging current and voltage operate as a source or a sink in either polarity in current or voltage mode. Program current and compliance voltage via the front panel, remote interfaces, or analog input. See Table 1-1 for DC Output Specifications.

Model 620	Model 622	Model 623:	Model 647
Current: 0 to ± 50 A	Current: 0 to ± 125 A	Current: 0 to ± 155 A	Current: 0 to ± 72 A
Voltage: 0 to ± 5 V	Voltage: 0 to ± 30 V	Voltage: 0 to ± 30 V	Voltage: 0 to ± 32 V
Max Power: 250 VA contin.	Max Power: 1 kVA contin.	Max Power: 1 kVA contin.	Max Power: 2 kVA contin.

Remote Sensing: Corrects for load lead drop of up to 0.5 V per lead. Operation with more drop per load lead is possible with a degradation of the load effect specification.

Output Terminals: The two rear panel output bus bars are isolated from the chassis (earth) ground.

Multiple Unit Operation: Connect up to four units in an auto-parallel configuration for increased output current capability.

Protection: Front panel annunciators, an audio indicator, and a contact closure indicate faults.

Remote Inhibit (RI): An active RI forces output settings to 0 A and 1 V until the RI is no longer active. To continue normal operation, enter new output settings.

Output Inhibit (OI): Press the front panel OI key to force output settings to 0 A and 1 V. To continue normal operation, enter new output settings.

Output Current Step Limit: The output current settings are forced to 0 A and 1 V if a preset current step limit is exceeded. A key entry is required to continue operation.

Utility Low Line or Loss: Maintains operation until load is discharged or utility is restored.

Utility High Line: Turns off input and maintains operation until load is discharged.

Overvoltage: Crowbars output when output terminal voltage, induced by the load exceeds ± 40 VDC.

Overtemperature: Crowbars output and turns off input when internal heat sink temperature exceeds 95 °C.

AC Input: Models 620/622/623 are factory set for operation from 100, 120, 200/208, 220, or 240 VAC (-10% , $+5\%$) 50 to 60 Hz single phase. Model 647 is factory set for operation from 200/208, 220, or 240 VAC (-10% , $+5\%$) 50 to 60 Hz single phase.

Input Protection: A front panel 20 A two-pole circuit breaker protects the AC input. The MPS turns off the breaker in the event of a fault.

Remote Interfaces: Serial Interface is standard; IEEE-488 is optional. All front panel functions can be controlled over the interfaces. In addition, interfaces output displayed quantities.

Input Current:

Table 1-1. Model 620/622/623 Input Current

Nominal Line Voltage (VAC)	Line Voltage Range (VAC)	Maximum Input Current (A rms)
100	90 to 105	18
120	108 to 126	15
200/208	180 to 218	9
220	198 to 231	8
240	216 to 252	7

Table 1-2. Model 647 Input Current

Nominal Line Voltage (VAC)	Line Voltage Range (VAC)	Maximum Input Current (A rms)
200	180 to 210	16
208	188 to 218	15
220	198 to 231	14
240	216 to 250	13

Front Panel: Contains a menu driven keyboard and graphic display for entry and display of results. Operating parameters to set and monitor from the front panel (and remote interface) include:

- Output current and compliance voltage setting.
- Output current and voltage measurement.
- Status reporting.
- Output ramp programming.
- Persistent switch heater control (with optional Model 6228 Card).
- Liquid helium level monitoring (with optional Model 6226/6476 Card).
- Field Monitoring (with optional Model 6226 Card).
- Output Current Zeroing.
- Output Current Step Limiting.

Magnet inductance and compliance ($di/dt = V_{SET}/L$) limit the output ramp programming charging current. Program output for a constant 0.01 to 99.99 amperes per second as long as compliance is not exceeded. Energize or de-energize the magnet at a pre-set ramp rate. Pause the ramp at any time during the ramp. During a pause, the MPS maintains output values until the ramp continues.

Operating Ambient Temperature: 15 to 35 °C (59 to 95 °F)

Dimensions: 483 mm wide x 178 mm high x 508 mm deep (19 x 7 x 20 inches)

Weight: 43.5 kilograms (96 pounds). Rack mounting is standard.

Table 1-3. Model 620/622/623 DC Output Specifications

SPECIFICATION	CURRENT	VOLTAGE
Digital Programming Resolution for 620/622	1 mA	1 mV
Digital Programming Resolution for 623	1.2 mA	1 mV
Digital Programming Accuracy	0.1% I_{MAX}	±30 mV
Digital Programming Repeatability	0.01% I_{MAX}	±30 mV
Electronic Resolution for 620/622	1 mA	1 mV
Electronic Resolution for 623	1.2 mA	1 mV
Electronic Accuracy	0.1% I_{MAX}	±30 mV
Display Resolution	1 mA	1 mV
Stability (Drift) at 25 ±1 °C: Percent of full scale output change over 8-hours under constant line and load after a 30 minute warm-up.	±0.005% I_{MAX}	±3 mV
Ripple and Noise: 10 Hz to 10 MHz at 1000 VA	20 µA rms	10 mV rms
Temperature Coefficient: Change in output per °C after 30 minute warm-up.	±0.01% I_{MAX}	±3 mV
Source Effect: Line regulation for any line change within the rated line voltage.	±0.005% I_{MAX}	±15 mV
Load Effect: Load regulation for a load change equal to maximum voltage in Constant Current Mode or maximum current in Constant Voltage Mode.	±0.01% I_{MAX}	±3 mV
Analog Resistance Programming Accuracy: 0 to 10 KΩ produces negative full scale to positive full scale current or voltage output. 5 KΩ is 0 current.	10% I_{MAX}	3 V
Analog Voltage Programming Accuracy: Voltage input is ±0.01 V/A, ±0.01 V/V.	1% + 100 mA	2% + 100 mV
Monitoring Output Accuracy: Voltage output is ±0.01 V/A, ±0.01 V/V.	1% + 100 mA	2% + 100 mV

Table 1-4. Model 647 DC Output Specifications

SPECIFICATION	CURRENT	VOLTAGE
Digital Programming Resolution: Standard/High	10 mA / 1 mA	10 mV / 1 mV
Digital Programming Accuracy	0.1% I_{MAX}	1% V_{MAX}
Digital Programming Repeatability	0.01% I_{MAX}	0.1% V_{MAX}
Electronic Resolution: Standard/High	4 mA / 1 mA	1 mV / 1 mV
Electronic Accuracy	0.1% I_{MAX}	0.1% V_{MAX}
Display Resolution: Standard/High	10 mA / 1 mA	10 mV / 1 mV
Stability (Drift) at 25 ±1 °C: Percent of full scale output change over 8-hours under constant line and load after a 30 minute warm-up.	±0.005% I_{MAX}	±0.01% V_{MAX}
Ripple and Noise: 10 Hz to 10 MHz at 1000 VA	40 µA rms	20 mV rms
Temperature Coefficient: Change in output per °C after 30 minute warm-up.	0.1% I_{MAX}	0.1% V_{MAX}
Source Effect: Line regulation for any line change within the rated line voltage.	0.005% I_{MAX}	0.05% V_{MAX}
Load Effect: Load regulation for a load change equal to maximum voltage in Constant Current Mode or maximum current in Constant Voltage Mode.	0.1% I_{MAX}	0.1% V_{MAX}
Analog Resistance Programming Accuracy: 0 to 10 KΩ produces negative full scale to positive full scale current or voltage output. 5 KΩ is 0 current.	10% I_{MAX}	10% V_{MAX}
Analog Voltage Programming Accuracy: Voltage input is ±0.01 V/A, ±0.01 V/V.	1% + 100 mA	2% + 100 mV
Monitoring Output Accuracy: Voltage output is ±0.01 V/A, ±0.01 V/V.	1% + 100 mA	2% + 100 mV

1.3 OPERATING CHARACTERISTICS

Many Lake Shore MPS operating characteristics ideally suit it for charge and discharge cycling of superconducting magnet loads. These characteristics significantly differentiate a Lake Shore MPS from a conventional MPS. Consider them when choosing the best MPS for a particular application.

1.3.1 True, Four-Quadrant Bi-directional Power Flow

Lake Shore MPS: Sets either positive or negative current and voltage values. This true, four-quadrant operation significantly simplifies test procedures and system design by eliminating external switching or operator intervention to reverse current polarity. The smooth, continuous transition through zero current allows users to analyze samples at very small current increments (as small as 1 mA) about zero. Power flow is bi-directional. Sink power (energy stored in the magnet) returns to the AC line instead of dissipating in an energy absorber. The MPS either transfers power from the AC line to the magnet, or from the magnet back to the AC line. The MPS also tolerates AC line faults; in the event of utility power failure, it draws power from the charged load to maintain operation until utility restoration.

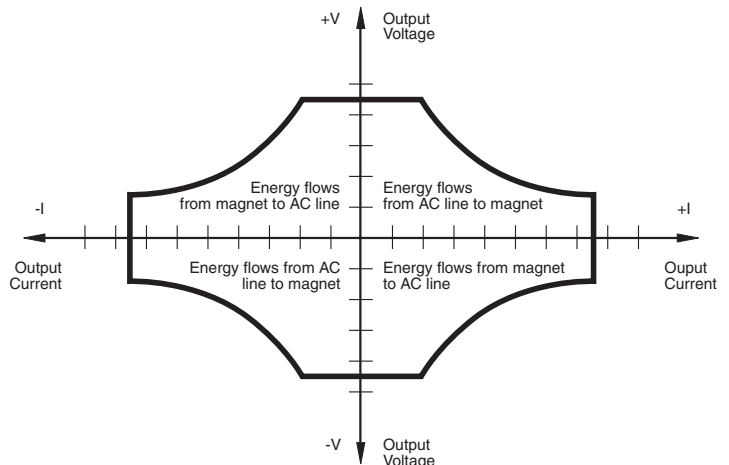

Figure 1-1. Four-Quadrant Power

Conventional MPS: Consists of a unipolar power supply with an energy absorber to dissipate magnet energy during discharge. The energy absorber prevents reverse voltage generated during the discharge from damaging the unipolar supply output. Other conventional supplies dissipate magnet energy in the power supply output transistor pass-bank. This two-quadrant performance requires the output stage to absorb considerable power during the discharge. In addition, uniform charge and discharge rates are not always ensured.

Current reversal requires external current reversal switches or manual lead reversal. These units provide pseudo-four-quadrant operation which introduces discontinuities at the current reversal point produced by switching the leads. Current reversal switches may incorporate direction detection diodes which reduce available magnet charging voltage and dissipate additional power. Current reversal switches must also interlock to prevent lead reversal when current is present. Current reversal switches complicate high power cabling requirements, increase chances of introducing output current instabilities, and require time to reverse leads. Manual lead reversal introduces discontinuity at the current reversal point. A discontinuous transition through zero current may require a small external supply for near zero current analysis. Utility power failure in a conventional supply generally results in a magnet quench.

1.3.2 Low Noise, High Stability Current Regulated Output

Lake Shore MPS: Maintains a high-stability, low-noise, current-regulated output. Digital setting and monitoring electronics, and computer interfacing integrate into power management and precision analog control circuitry. This integration maintains high output stability and repeatability. Extensive output filtering and noise cancellation circuitry keep MPS output noise very low. The MPS front panel graphic display allows continuous display of output current and voltage while setting parameters from the menu-driven keypad. In addition to the front panel and remote interface programming, the MPS includes analog inputs and outputs for setting and monitoring operating parameters. The MPS requires only 7 inches of rack space.

Conventional MPS: Some use a compliance limited output with current monitoring to charge the magnet. Others require output current to drive against the output current limit to prevent output current drift. Most use multi-turn potentiometers and digital (or analog) panel meters for front panel current and compliance voltage setting. The elegance and repeatability of keypad entry is not available. There is no digital setting or monitoring integration in the output control circuitry. Most achieve computer interfacing by adding computer controlled voltage sources to analog program the output current and voltage. Additional inputs must be added to digitize the output current and voltage. Setting and monitoring resolution is one to two orders of magnitude poorer than the standard MPS provides. External setting and monitoring complicates cabling. Degradation of the output current stability due to the addition of external cabling is undefined. Output noise specifications are rarely given and sometimes vary with the type of magnet load driven. These multiple unit configurations require up to 36 inches of rack space.

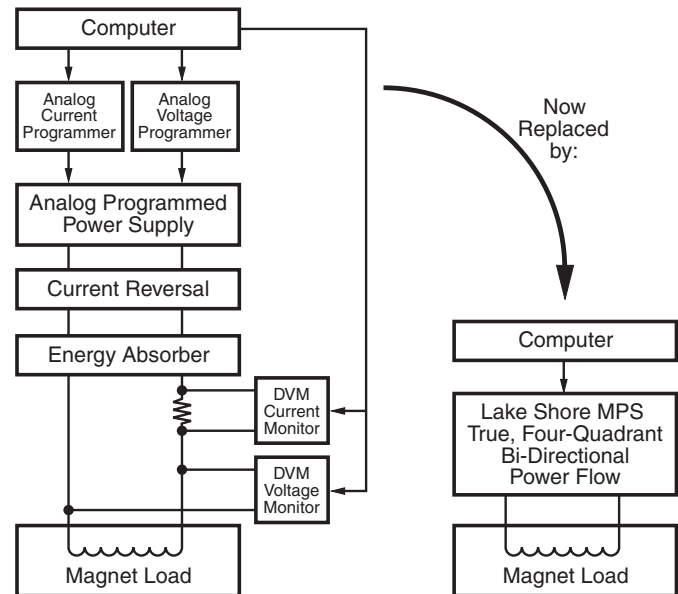

Figure 1-2. Comparison of Old and New MPS Designs

1.3.3 Highly Efficient, Air Cooled, Compact Unit

Lake Shore MPS: Quiet switched-mode design. The output uses a proprietary pulse width modulated technique that incorporates power hybrid circuitry. Extremely low conduction loss components minimize internal power dissipation. The MPS is not a direct off-line switching supply. The output is fully floating and isolated from ground. Active power factor correction draws a sinusoidal AC current waveform from the utility, minimizes AC line harmonics, and lowers AC current required. Power factor is the ratio of real power (measured in watts) to the apparent power (measured in volt-amperes). The combination of quiet switched-mode design and active power factor correction results in a compact, highly efficient, air-cooled unit.

Conventional MPS: Most use linear regulated outputs. The output transistor pass-bank internally dissipates power not delivered to the magnet. Some units use an off-line switching supply to provide the bulk power and add output regulation. There is no input power factor correction. Low overall efficiency means higher input power and current. Without power factor correction, a non-sinusoidal current with high peaks places tremendous stress on fuses, circuit breakers, outlets, and wiring. Dedicated lines may be required because of potential interaction with other equipment. These factors result in low overall efficiency, large size, and considerable weight.

CHAPTER 2

INITIAL SETUP AND CONNECTIONS

2.1 INSPECTING AND UNPACKING

The MPS ships in a special cardboard box with integrated forklift skid openings. Do not stack anything on top of the MPS box. Upon receipt, set the box on a level surface with the pallet side down. Inspect the shipping container for external damage. Make all claims for damage (apparent or concealed) or partial loss of shipment in writing to Lake Shore within five (5) days from receipt of goods. If damage or loss is apparent, notify the shipping agent immediately.

Cut off the plastic strapping and lift off the lid. Locate the MPS packing list and use it to check for receipt of all components, cables, accessories, and manuals. Inspect each item for damage. Use two people to lift the MPS. Retain internal packing material and box for reshipment. Fill out and send the warranty card.

If there is freight damage to any instruments, promptly file proper claims with the carrier and insurance company and notify Lake Shore Cryotronics. Notify Lake Shore of any missing parts immediately. Lake Shore cannot be responsible for any missing parts unless notified within 60 days of shipment. See the standard Lake Shore Cryotronics, Inc. Warranty on the A Page (immediately behind the title page).

2.2 MPS MOUNTING

After unpacking the MPS and verifying receipt of all packing list items, mount the instrument in a suitable location. The MPS ships with feet installed and is ready for use as a bench top instrument. The MPS also ships with 19-inch rack mounting hardware installed for mounting in a standard 19-inch rack enclosure.

CAUTION: To install the MPS in a 19-inch rack mount enclosure at any position other than the bottom, install a slide rail or runner to support the MPS.

2.3 ENVIRONMENTAL REQUIREMENTS

Operate the MPS in an area with an ambient temperature range of 20 to 30 °C (68 to 86 °F). The unit may be operated within the range of 15 to 35 °C (59 to 95 °F) with reduced accuracy.

The MPS is intended for laboratory use: no specific humidity or altitude specifications have been determined. However, relative humidity of 20 to 80 percent (no condensation) and altitudes from sea level to 2.4 km (8,000 feet) are generally acceptable.

WARNING: To prevent electrical fire or shock hazards, do not expose this instrument to moisture.

Provide adequate ventilation. The fan-cooled MPS draws air in from the sides and exhausts it from the rear; install it with sufficient space at the rear and sides for air flow. Filter dust and other particulate matter at the site to a reasonable level. For salt air, corrosive gases, or other air pollutants, consult an air-conditioning expert for special filtering arrangements.

2.4 CONNECTING THE MPS TO POWER

Read and thoroughly understand sections 2.4.1 through 2.4.3 and the safety recommendations in the Foreword before connecting the MPS to power. Failure to do so may expose operating personnel to lethal voltages or damage the magnet and/or MPS.

2.4.1 Power and Ground Requirements

The AC power source for the MPS should be frequency and voltage regulated and isolated from sources that may generate Electromagnetic Interference (EMI). The MPS is designed for single-phase 3-wire alternating current (AC) power; do not use two-wire (without ground) AC power. Lake Shore recommends Ground Fault Interrupter (GFI) and Transient Surge Protection circuitry at the AC source.

In areas where AC voltage varies, consider using a constant voltage transformer. For power outages, consider using an Uninterruptible Power Supply (UPS).

CAUTION: Do not attempt to apply electrical power until the MPS is checked for proper line voltage settings.

Factory-preset MPS line voltage requirements allow proper operation at the shipping destination. The line voltage setting is indicated on the rear panel. Before applying power to the main input power cable, check for correct input power settings for the power source voltage.

Ground the instrument panels and cabinets. The safety ground provides a true ground path for electrical circuitry and, in the event of internal electrical faults such as shorts, carries the entire fault current to ground to protect users from electrical shock. The MPS has a three-conductor power input connector which grounds the MPS chassis when plugged into a 3-wire receptacle.

EMI is both a natural and man-made electromagnetic phenomena which, either directly or indirectly, may degrade electronic system performance. Natural EMI includes thunderstorms, solar disturbances, cosmic rays, etc. Man-made EMI includes fixed and mobile transmitters, high voltage power lines, power tools and appliances, florescent lights, and other equipment containing motors, heaters, etc. Protect the AC source from EMI. Consider transient surge protectors for lightning protection.

2.4.2 MPS Input Power Ratings

Operate the Model 620/622/623 from a nominal 100, 120, 200/208, 220, or 240 VAC (–10%, +5%) single-phase AC power source, 50 to 60 Hz. Table 1-1 lists input voltage range and maximum current required for each nominal input.

Operate the Model 647 from a nominal 200/208, 220, or 240 VAC (–10%, +5%) single-phase AC power source, 50 to 60 Hz. Table 1-2 lists input voltage range and maximum current required for each nominal input.

A rear panel label indicates MPS factory-preset nominal line voltage. Normally, the line voltage setting is not changed in the field. Consult the factory to reconfigure the input power.

2.4.3 Input Power Connections

The MPS uses a three-prong detachable input power connector (supplied) to mate with the UL/CSA/IEC approved rear panel AC input connector. The user supplies a three conductor power cord rated for at least 85 °C operation. For 100 or 120 VAC operation, each conductor must be AWG #14 or larger. For 200/208, 220 or 240 VAC operation, each conductor must be AWG #16 or larger. Larger wires may be required to prevent excessive voltage drop in the AC power lines if the unit is located an extended distance from the main AC distribution terminals.

WARNING: For proper circuit breaker protection, mate the wire connected to the “L” terminal of the connector to the “L” (hot) side of the line and mate the wire connected to the “N” terminal to the “N” (neutral) side of the line. Mate the wire connected to the “GND” terminal to earth ground. Do not operate this instrument without an adequate ground connection.

CAUTION: Before applying power to the MPS, verify that the AC source matches the line voltage listed on the rear panel.

NOTE: Make connections to the AC power line in accordance with applicable electrical codes. The international color code for identifying utility supply conductors is green/yellow for earth (“GND”), blue for neutral (N), and brown for line (L). The US and Canadian codes are green for earth (“GND”), white for neutral (N), and black for line (L).

Use this procedure to connect input power to the MPS:

1. Loosen the two connector cover screws and open the cover.
2. Slip the strain relief over the power cable with the flanged end at the end to be terminated.
3. Attach the wires to the connector in accordance with prevailing color codes: green or green/yellow to the "GND" terminal, white or blue to the "N" terminal, and black or brown to the "L" terminal.
4. Position the strain relief, close the cover, and then tighten the cover screws.
5. Connect the other end of the power cord to an appropriate AC power source.
6. Plug the power cord into the detachable power connector plug on the MPS rear panel.

2.5 POWER UP

Read and follow instructions in Paragraphs 2.1 thru 2.4.3 and safety recommendations in the Foreword before applying power to the MPS. Do not connect the MPS to the magnet at this point. Short the output terminals together with a #4 gauge or larger cable. This protects the magnet against incorrect configurations.

Turn on the MPS. It requires approximately 2 seconds for initialization. Initially, all front panel annunciators come on and the alarm sounds for a short time. Within 1 second, the Fault and Persistent Switch Heater On annunciators and the alarm turn off. If the MPS detects a high or low AC line fault, it blinks the front panel Fault annunciator and turns off the input circuit breaker. If this occurs, verify that the AC source matches the line voltage listed on the MPS rear panel. The MPS front panel AC On LED lights any time the MPS is connected to the AC line and the MPS power switch is ON.

Initially, the entire display clears and the alarm sounds for a short time. The MPS initializes itself and displays the model identification. The Normal Display screen appears with a blinking asterisk indicating each update when the unit is in normal operation.

2.5.1 Magnet Cable Connections

WARNING: Turn off the AC power before changing any rear panel connections and verify that all connections are securely tightened before reapplying power.

CAUTION: Initially, setup the MPS without connecting it to the magnet. This lessens the chance for inadvertent damage to the load while the user learns MPS operation.

Make MPS load connections at the +OUT and -OUT terminals on the rear panel. These plated copper bus bars accommodate 1/4 inch mounting hardware. Use load wires heavy enough to limit the voltage drop to less than 0.5 volts per lead. This ensures proper regulation and prevents overheating while carrying the output current. Use remote sensing to compensate for any voltage drop in the load leads and obtain a more accurate voltage reading.

Table 2-1. Load Wire Lengths and Current Capacity

AWG	Area (mm ²)	Capacity Amperes	Resistivity Ω/1000 feet	Total Lead Length (feet)		
				75 A	100 A	125 A
0	53.5	245	0.09827	135	101	81
2	33.6	180	0.1563	85	64	51
4	21.2	135	0.2485	53	40	32
6	13.3	100	0.3951	33	25	—
8	8.4	75	0.6282	21	—	—

Stranded AWG #4 wire is capable of carrying in excess of 125 amperes. Keep conductor temperature under 85 °C for a 35 °C ambient. Table 2-1 lists the ampere capacity and total +OUT and -OUT lead lengths for load connections.

If connecting multiple loads to the unit, use separate pairs of wires to connect each load to the output terminals. Cut each pair of connecting wires as short as possible.

2.5.2 Shielding, Grounding, and Noise

For noise reduction, tightly twist and shield the leads from the MPS to the magnet. Connect the shield to the MPS chassis as shown in Figure 2-3.

WARNING: DO NOT place magnet leads in contact with other MPS/system connections or metal parts.

In some instances, the user's measurement leads may pick up noise from the magnet leads. Although this common mode noise may affect the user's measurement it rarely affects the current in the magnet. If the user's measurement is earth grounded, some improvement is almost always possible by tying the –OUT terminal of the MPS to earth ground – either at the MPS chassis or, if the user's system has one, the common system earth ground point.

WARNING: If the –OUT terminal is tied to earth ground, make certain the +OUT cable from the MPS contacts no other earth ground point - it forces the MPS output current into this other ground point. If the other ground point is a small wire, it may melt or catch fire.

2.5.3 MPS Remote Inhibit and Fault Indicator Connections

The MPS has a Fault Indicator (FLT) output and a discrete Remote Inhibit (RI) input which are both interface independent and provide fault indication and remote output shutdown in the event of catastrophic failure. The Fault Indicator relay contact is open when the MPS detects no faults. When the MPS detects an internal fault, a remote inhibit, or an output inhibit, it lights the front panel Fault LED and closes the relay contact. The contact closure alerts other system components of the fault. In an auto-parallel system (up to four MPS units connected in parallel) these signals connect in parallel between each of the MPS units (See Paragraph 2.6 for details on connections between two auto-parallel units). Make connections to a rear panel detachable terminal block defined in Table 2-2 and Figure 2-1.

Table 2-1. RI, FLT, ON, and OVP Connections

TERMINAL	LABEL	DEFINITION
1 2	RI+ RI–	Remote Inhibit – Active low, TTL-compatible input to remotely force the output settings to 0 A and 1 V. Also activate RI by shorting +RI to -RI with a relay contact closure or a switch.
3 4	FLT+ FLT–	Fault Indicator – A relay contact that closes to indicate a fault. Contact rating: 0.25 A resistive at 100 VDC, 3 W, 25 VA.
5 6	ON+ ON–	ON Indicator – A relay contact that closes to indicate when the front panel circuit breaker is in the ON position. Contact rating: 0.25 A resistive at 100 VDC, 3 W, 25 VA.
7	NONE	Factory Use Only. Do not connect to this terminal.
8	OVP	In auto-parallel MPS configurations, OVP ensures that the activation of one MPS Over Voltage Protection circuit activates all the other parallel MPS units' protection circuits.

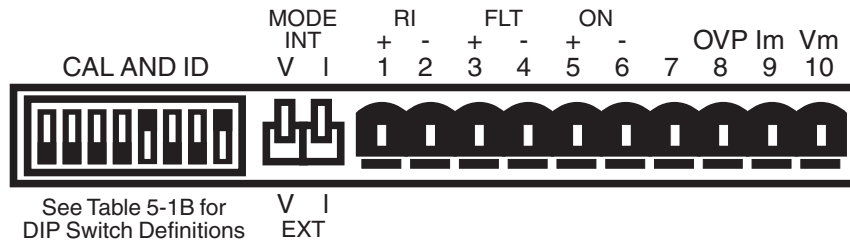

Figure 2-1. RI, FLT, ON and OVP Connections

2.5.4 AC On Indicator

The MPS provides a discrete ON indicator. Terminals 5 and 6 on the terminal block connector, shown in Figure 2-1 above, connect to relay contacts that close when the front panel circuit breaker is in the ON position. There is also a front panel LED that lights when the MPS is ON and connected to AC power.

2.5.5 OVP Connection

In auto-parallel MPS configurations, this connection synchronizes the firing of the Over Voltage Protection (OVP) circuits of each MPS (see Paragraph 4.7.4). See Paragraph 2.6 and Figure 2-4 for auto-parallel connections.

2.5.6 MPS Analog Current And Voltage Monitoring Connections

The MPS provides amplified and buffered current and voltage monitor output signals at the terminal block on the back panel. Connect these signals to external meters to indicate output current and voltage. Obtain the Current Monitor signal through connections to terminals 9 (Im) and 11 (m) with positive output currents producing a positive monitor voltage of 10 mV/A from Im to m.

Obtain the Voltage Monitor signal through connections to terminals 10 (Vm) and 11 (m) with positive terminal voltages producing a positive monitor voltage of 10 mV/V from Vm to m.

2.5.7 External Current Programming

Remotely program MPS output current by an external voltage or potentiometer. Enable external analog programming via the rear panel I MODE switch. When the I MODE switch is in the INT I position, external current mode is disabled. When the I MODE switch is in the EXT I position, the external programming voltage is summed with the internal programming voltage. Set the internal programming to zero for external programming only. Apply an external voltage from Ip to m of 0 to 1.25 volts or use a 10 KΩ potentiometer to control the output current over the entire range. Make connections to rear panel detachable terminal block defined in Tables 2-3 and 2-4 and Figures 2-1 and 2-2. The MPS produces 100 A of output current for 1 V at the current programming input.

NOTE: MPS protection circuits reduce the effect of open external programming leads. An open external programming lead forces external programming voltage to approximately 0 volts.

2.5.8 Remote Sense Connections

The factory configures the MPS to *sense*, but not *control* remote voltage. Call Lake Shore to reconfigure the MPS to *control* voltage at the load. When using remote sense, the MPS measures voltage at the magnet instead of at the MPS output terminals allowing a more accurate reading of magnet voltage by eliminating voltage drops in the leads connecting the MPS to the magnet. If using remote sense, the MPS bases the voltage at the voltage monitor output on the remote sense voltage instead of the MPS terminal voltage.

Use AWG #24, shielded, twisted pair wiring for sense leads to minimize pickup of external noise. Any noise on the sense leads may appear at the unit output. Ground sense shield to the MPS back panel.

Make Remote Sense Connections to the rear panel detachable terminal block defined in Table 2-3 and Figure 2-2.

Table 2-2. Analog Monitoring, Programming, and Remote Sense Connections

TERMINAL	LABEL	DEFINITION
9	Im	Output Current Monitor – Voltage output from Im to GND(M) is ± 10 mV/A.
10	Vm	Output voltage monitor – Voltage output from Vm to GND(M) is ± 10 mV/V.
11	m	Monitor and program ground. GND(m).
12	Vp	Not Used.
13	+Vs	Not Used.
14	-Is	Negative voltage supply for programming external current with a potentiometer
15	Ip	Current programming input voltage. Voltage input from Ip to GND(m) produces ± 100 A/V. Voltage may come from a voltage source or from the center tap of a potentiometer connected from -Is to +Is.
16	+Is	Positive voltage supply for programming external current with a potentiometer.
17	-S	Remote voltage sense correction.
18	+S	Correction for load lead drops of up to 0.5 V per lead.

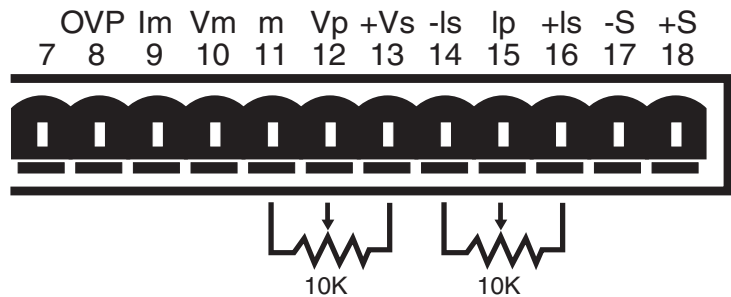

Figure 2-2. Analog Monitoring , Programming, and Remote Sense Connections

NOTE: The MPS includes a protection circuit which reduces the effect of open sense leads during remote voltage sensing operation. If the +S lead opens, the output voltage changes because it is sensed between +OUT and the negative side of the load. If the –S lead opens, the output voltage changes because it is sensed between the positive side of the load and –OUT. If both leads open, the output voltage is sensed internally.

The procedure below configures the MPS for remote voltage sensing as shown in Figure 2-3.

1. Turn off the unit.
2. If present, disconnect any wires between the +OUT and –OUT terminals and the +S and –S connections on the MPS rear panel.
3. Connect the sense leads from the MPS +S and –S connections to the load. Maintain polarity when making these connections.

CAUTION: Maintain polarity between +S and +OUT and –S and –OUT. The +S and –S inputs control the output voltage. Improper polarity may apply damaging voltages to the load.

4. Connect the ground shield to the mounting screw. Make sure that the shield does not come into electrical contact with either magnet lead.

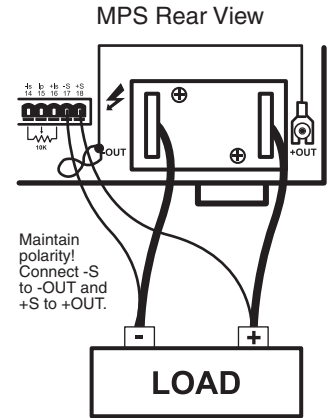

Figure 2-3. Remote Sensing Connections

2.6 MULTIPLE AUTO-PARALLEL SETUP

Connect up to four MPS units in an auto-parallel configuration for increased output current capability. The maximum total current allowed is the sum of the maximum currents of the individual units. For example four 623 MPS units provide $4 \times 155 = 620$ amps total current. The maximum total power is the sum of the maximum power ratings of the individual units.

Assign each unit a unique address: 1 for MPS 1, 2 for MPS 2, etc. The MPS at address 1 polls the control bus to determine if an auto-parallel configuration is present and how many MPS units are involved. When multiple MPS units are present, MPS 1 sends the output current and voltage limits, ramp status, output current step limit, and other operating parameters to the other MPS units so all units operate identically.

For two MPS configuration, each MPS is programmed for half of the total output current. This is true for the ramp destination current and ramp rate. Each MPS contributes half the output current required. MPS 1 software polls MPS 2 to determine the total output current. The output voltage, current settings during a ramp, and instrument status from MPS 1 are reported (since the values are the same for both units.)

NOTE: When multiple MPS units are present, install the Model 6228 persistent switch heater output option in MPS 1 for proper operation.

An analog signal is also provided for remote activation of the output over voltage protection (OVP) circuit. The signals connect in parallel so that the output OVP circuits of each MPS activate in unison.

CAUTION: Consult Lake Shore prior to operating multiple MPS units in auto-parallel mode.

Use the procedure below and see Figure 2-4 to connect multiple MPS units in auto-parallel configuration:

1. Turn off all units and completely disconnect power at the source before changing MPS configuration.
2. Determine which MPS to assign as MPS 1 and configure it as follows:
 - a. Locate the CAL AND ID DIP switches on the rear panel. Turn ON (up position) switches 1 and 4. Turn OFF (down position) switches 2, 3, and 5 through 8. (Switch 4 ON designates multiple MPS operation. Switches 3, 2, and 1 respectively OFF, OFF, and ON assign the MPS address as 1). Note that the CAL AND ID switch numbers are upside down (as viewed from the rear panel). Switch 1 is on the right and switch 8 is on the left. Take care to use the correct switch numbers.
 - b. Move the I MODE switch to the INTernal (up) position.

- c. Locate Communications Microprocessor (CMP) in the MPS rear panel. The CMP is the module with two RJ-11 telephone jacks. Loosen two screws securing CMP to MPS rear panel and slide CMP out. Just inside the CMP front panel, there is a set of DIP switches. Verify that switches 5, 6, and 7 are ON (closed) and switches 1 through 4 and 8 are OFF (OPEN). (Switches 1–4 define the control bus as Serial (RS-232C). Switches 5–8 define the control bus as RS-485 multidrop. Switch 8 terminates the bus for long communications loop runs. Close switch 8 to terminate the control bus only if the MPS units are a significant distance from each other.) Replace the CMP.
3. Configure the second MPS as MPS 2:
 - a. Locate the CAL AND ID switches on the rear panel. Turn ON (up position) switches 2 and 4. Turn OFF (down position) switches 1, 3, and 5 through 8. (Switch 4 ON designates Multiple MPS operation. Switches 3, 2 and 1 as OFF, ON, OFF, respectively, assign the MPS address as 2.)
 - b. Move the I MODE switch to the INTernal (up) position.
 - c. On the CMP, verify that switches 5, 6 and 7 are ON (closed) and switches 1 through 4 and 8 are OFF (OPEN). Replace the CMP.
 4. Connect the control bus. Use Lake Shore Model 2001 Modular Cables (provided) to interconnect the two MPS CMP units.
 5. Connect the MPS 1 over voltage protection (OVP) pin 8 to MPS 2 pin 8.
 6. Connect the RI and FLT signals. Connect the +RI (terminal 1) to the +FLT (terminal 3) on MPS 2. Connect the –RI (terminal 2) to the –FLT (terminal 4) on MPS 2. Do the same on MPS 1. Connect the +RI/+FLT connection of MPS 2 to the +RI/+FLT connection of MPS 1. Connect the –RI/–FLT connection of MPS 2 to the –RI/–FLT connection of MPS 1. If an external contact closure will remotely inhibit operation, connect it across the +RI and –RI terminals of MPS 1. The +FLT and –FLT contact closure of MPS 1 indicates a fault.
 7. Connect the +OUT terminal of MPS 1 to the +OUT terminal of MPS 2. Connect the –OUT terminal of MPS 1 to the –OUT terminal of MPS 2. Make these leads as short as possible to minimize output potential differences between the two MPS units and large enough to handle the maximum MPS current. Connect the output terminals to the load using leads large enough to handle the total output current of both MPS units.

NOTE: For proper operation, turn on MPS 1 and then MPS 2 within 15 seconds of MPS 1.

8. Verify all connections as summarized in Table 2-4.
9. To add a third MPS or a fourth MPS in parallel, make the RI/FLT, OVP, CMP and output connections in parallel with the connections of MPS 1 and MPS 2. For MPS 3, set the CAL AND ID switches on the rear panel as follows : switches 5 through 8 are OFF, switches 4, 3, 2 and 1 are ON, OFF, ON, ON respectively. For MPS 4, set the rear panel CAL AND ID switches as follows : switches 5 through 8 are OFF, switches 4, 3, 2 and 1 are ON, ON, OFF, OFF respectively. Configure the CMP switches for MPS 3 and MPS 4 as those in MPS 1 and MPS 2.

Table 2-3. Two-MPS Autoparallel Configuration Connections

MPS 1	MPS 2
Control Bus	Control Bus
8 (OVP)	8 (OVP)
1 (+RI), 3 (+FLT)	1 (+RI), 3 (+FLT)
2 (–RI), 4 (–FLT)	2 (–RI), 4 (–FLT)
+OUT	+OUT
–OUT	–OUT

NOTE: For proper operation, turn on MPS 1 and then the remaining MPS units within 15 seconds.

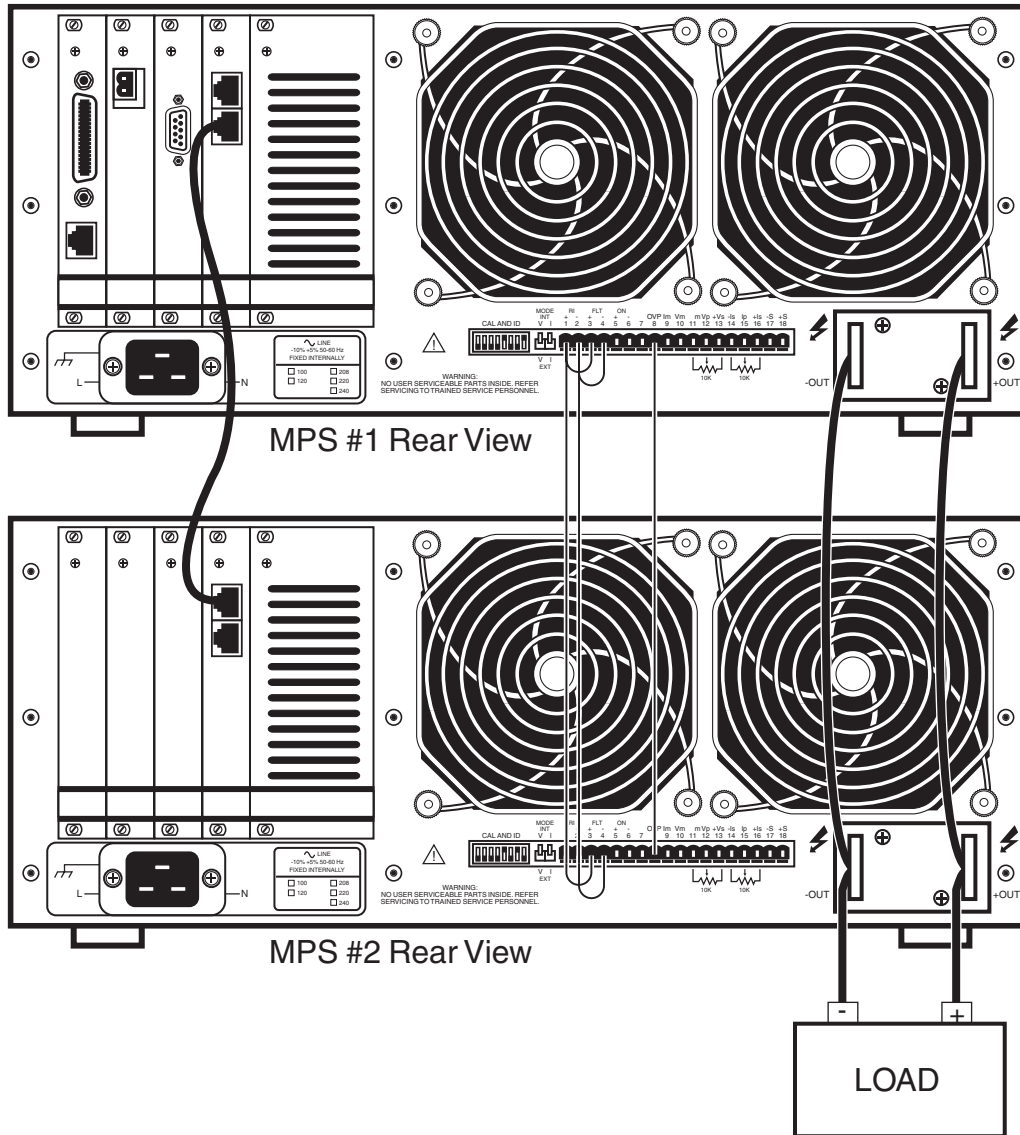

Figure 2-4. Typical Multiple MPS Connections for Two MPS Units

2.6.1 Multiple MPS Remote Inhibit Mode

In multiple MPS configuration, if the MPS RI indicators activate from an external contact closure, the MPS units enter Multiple MPS Remote Inhibit Mode. They activate output overvoltage protection circuits and turn off output circuits. If a charged load is present, OVP circuits discharge it. The front panel Fault annunciators turn ON, and the internal audio indicators beep about once per second. If a MPS detects a fault, it initiates Multiple MPS Remote Inhibit Mode by closing the FLT contacts. No delay is allowed (CAL AND ID switch 7 OFF, down position) and multiple MPS operation (CAL AND ID switch 4 ON, up position) must be selected. After the load discharges, turn OFF all units to reset.

2.7 POST-INSTALLATION INSTRUCTIONS

The MPS is electrically and mechanically inspected and operationally tested prior to shipment. It should be damage-free and in perfect working order upon receipt. To confirm this, visually inspect the instrument for damage and test it electrically to detect any concealed damage upon receipt. Study the entire MPS User's Manual before attempting to run the unit. See Chapter 3 for any questions on front panel control operation.

2.8 SYSTEM SHUTDOWN AND REPACKAGING FOR STORAGE OR SHIPMENT

Follow these general guidelines for system shutdown for storage or reshipment. If returning something, call Lake Shore first to obtain a Return Goods Authorization (RGA) Number.

1. Turn off the power to all instruments. Unplug the power cord.
2. Remove or disconnect any interface cables and the magnet current output cables.
3. Repack the MPS upside down in the original box. If returning the MPS to Lake Shore and original box is unavailable, please call Lake Shore for a replacement box.
4. Label the box for storage or shipment.

2.9 RETURNING EQUIPMENT TO LAKE SHORE

To return the MPS for repair or replacement, obtain a Return Goods Authorization (RGA) number from a factory representative before returning the instrument to our service department. When returning an instrument for service, Lake Shore requires the following information before attempting any repair:

1. Instrument model and serial number.
2. User's name, company, address, and phone number.
3. Malfunction symptoms.
4. Description of system.
5. Returned Goods Authorization number.

Consult the factory for shipping instructions. Ship the MPS upside down in the original shipping box.

This Page Intentionally Left Blank

CHAPTER 3

OPERATION

3.0 GENERAL

This chapter covers seven areas: MPS Front Panel (Paragraph 3.1), Power Up (Paragraph 3.2), Setting Current on an MPS with Manual PSH Control (Paragraph 3.3), Setting Current with Automatic PSH Control (Paragraph 3.4), Instrument Setup Screens (Paragraph 3.5), Function Menus (Paragraph 3.6), and an Automatic Persistence Control Example (Paragraph 3.7).

Setup the MPS software with the MPS output terminals shorted together as in section 3.2. This ensures that while the user learns MPS operation, an inadvertent keystroke causes no damage to the magnet.

3.1 THE MPS FRONT PANEL

Figure 3.1 below shows the MPS Front Panel. The up or down Display Cursor Control keys move the line indicator to the line containing a value to be changed. Use either the Data Entry Keypad to enter the desired value or the up or down Numeric Entry keys to increment or decrement the value. The Enter key accepts the update, while the Esc key discards the change and returns to the prior value. Move the cursor to a particular digit with the right and left Display Cursor Control keys and change it with the Numeric Entry keys.

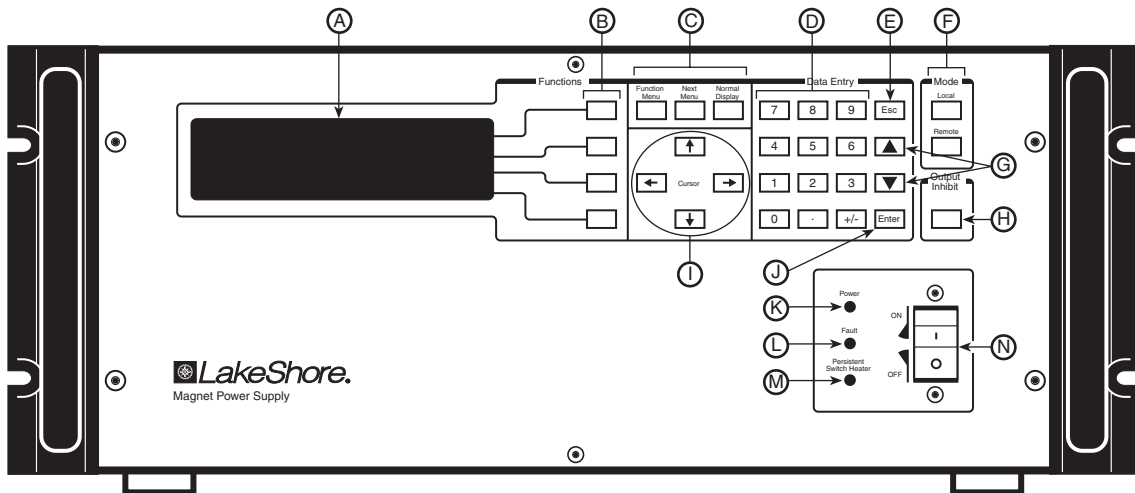

- A. Display Screen
- B. Display Function Keys
- C. Display Menu Selection Keys
- D. Data Entry Keypad
- E. Escape Key. Restores an old value and returns from a Function Screen to Normal Screen. Also Aborts a ramp or automatic process.
- F. Interface Keys
- G. Data Entry Up and Down Keys. Increment and decrement numeric values, Pause/Restart ramps, or execute some functions.
- H. Output Inhibit Key
- I. Display Cursor Control Keys
- J. Enter Key. Accepts a change.
- K. Power Indicator
- L. Fault Indicator
- M. Persistent Switch Heater Indicator
- N. Power Switch

Figure 3-1 MPS Front Panel

3.2 POWER UP

Read and follow instructions in Paragraphs 2.1 - 2.4.3 and the Forward safety recommendations before applying power to the MPS. **Do not connect the MPS to the magnet yet.** Short the output terminals together with a #4 gauge or larger cable to protect the magnet against incorrect configurations.

Turn on the MPS. It requires approximately 2 seconds for initialization. Initially, all front panel annunciators come on and the alarm sounds for a short time. Within 1 second, the Fault and Persistent Switch Heater On annunciators and the alarm turn off. If the MPS detects a high or low AC line fault, it blinks the front panel Fault annunciator and turns off the input circuit breaker. If this occurs, verify that the AC source matches the line voltage listed on the MPS rear panel.

Initially, the entire display clears and the alarm sounds for a short time. The MPS initializes itself and displays the model identification. The Normal Display screen appears with a blinking asterisk indicating each update when the unit is in normal operation.

Depending on the existence of the PSH Option Card and the mode of operation, the MPS displays one of three possible Normal Displays on power up: one for Manual Mode (no PSH Option Card), one for Manual PSH Control, or one for Automatic PSH Control. The factory-preset is the Normal Display for Manual Mode, but the MPS remembers the last PSH mode selected at power down and powers up in that mode. Without an PSH option installed, the MPS powers up in the Normal Display for Manual Mode.

Set Magnet Ramp Rate and Persistence Switch Ramp Rate in the Normal Display screen. Set Field Units, Maximum Current, and Compliance Voltage in the Instrument Setup Screen. Set Current Step Limit in the Step Limit/Zero screen.

CAUTION: Set magnet parameters according to manufacturer's specifications. Failure to do so may damage the magnet and threaten user safety.

3.3 NORMAL DISPLAY FOR MANUAL MODE

Shown to the right is the default startup Normal Display for Manual Mode. For operation with the PSH card installed see Paragraph 3.4 for MANUAL persistence mode or Paragraph 3.5 for AUTOMATIC persistence mode.

```

SETTINGS:                                OUTPUTS: *
++ 0.1999A                               +1.999A
COMPLIANCE  ± 1.000V                       +0.001V
RAMP RATE   ± 1.000A/S
RAMP ENABLE: <OFF> ‡
    
```

The Normal Display screen allows entry of MPS output current (or field) settings at any time. Settings cannot exceed limits in the INSTRUMENT SETUP screen. The OUTPUTS portion of the screen indicates output values and computer interface status. The Normal Display key returns the display to this screen at any time.

Use the Cursor keys to move the line indicator up or down. Parameters with a ‡ icon toggle with the Data Entry up or down key. Change all others using any numeric entry mode, including the cursor.

CURRENT / FIELD:

MPS Output Setting. This line reads CURRENT if set to display amps and FIELD if set to display computed field (see Paragraph 3.6.1.4). To set MPS output, move to the CURRENT / FIELD line and enter the new setting. If RAMP ENABLE is ON, the current or computed field ramps to the new setting at the displayed RAMP RATE. If RAMP ENABLE is OFF, the current or field changes to the new value immediately or to the value that causes MPS voltage COMPLIANCE. However, it is not recommended to operate the MPS with RAMP ENABLE OFF; it may cause a magnet quench (see Forward).

COMPLIANCE (Read only):

Compliance Setting. Change the COMPLIANCE voltage in the INSTRUMENT SETUP screen (See Paragraph 3.6.1.4).

RAMP RATE:

Ramp Rate Setting. Exceeding the maximum rated magnet voltage or current ramp rate may damage the magnet. Users may configure the MPS to limit the voltage by adjusting the compliance. If RAMP ENABLE is ON, RAMP RATE controls the rate at which the magnet current reaches the current setpoint as long as the MPS does not go into compliance. (See Paragraph 3.6.1.4).

NOTE: To pause or restart a ramp, press either the Data Entry up or down key. To abort a ramp, press **Esc**.

The magnet manufacturer supplies the inductance of the magnet, maximum ramp voltage, and maximum current ramp rate. The relationship for these parameters is given by the equation:

$$V_{max} \geq L \frac{di}{dt}$$

where: V_{max} = rated maximum magnet ramp voltage in volts,
 L = magnet inductance in henrys, and
 di/dt = maximum magnet current ramp rate in amps/second.

To set the Magnet Ramp Rate for manual PSH control or no PSH control, move to the RAMP RATE line and enter a ramp rate less than the magnet's maximum ramp rate. In manual PSH control, the MPS uses the RAMP RATE value to ramp both the magnet current and the persistence switch current. To activate ramping, move to the RAMP ENABLE line and toggle RAMP ON. Upon entering a new current set point, the current ramps at the entered ramp rate.

RAMP ENABLE: <ON> or <OFF>

RAMP ENABLE ON causes current to ramp at the specified ramp rate when the current/field is changed. Turn RAMP ENABLE OFF to force the MPS to step immediately to the new CURRENT (or FIELD) SETTING. Move to the RAMP ENABLE line and toggle the RAMP ENABLE OFF.

3.4 NORMAL DISPLAY FOR MANUAL PSH CONTROL

To the right is the default start-up Normal Display screen for an MPS with a PSH option card installed and Manual Persistence Control Mode selected. To change to Automatic Persistence Control Mode, press the MENU key and select Automatic Mode from Function Menu 1. For Automatic Persistence Control Mode see Paragraph 3.5.

```

SETTINGS:                                OUTPUTS: *
+ 0.1999A                                +1.999A
COMPLIANCE :± 1.000V                      +0.001V
RAMP RATE  :± 1.000A/S
RAMP ENABLE: <OFF>
PERSISTENCE: <ON>
    
```

The Normal Display for Manual PSH Control functions the same as the Normal Display for Manual Mode with the exception of the option below:

PERSISTENCE: <ON> or <OFF>

Persistence Mode Status. If Persistence Mode is On, the PSH heater is Off. If it is Off, the PSH heater is On.

Note: To set PSH heater current, see Chapter 6 Options And Accessories.

3.5 NORMAL DISPLAY FOR AUTOMATIC PSH CONTROL

To the right is the default startup Normal Display screen for an MPS with a PSH option card installed and Automatic Persistence Control selected. To change to Manual Persistence Control Mode press the MENU key and select MANUAL MODE. For Manual PSH Control Mode, see Paragraph 3.4.

```

AUTOMATIC MODE:                          OUTPUTS: *
+MGT START  : 0.000A                      +0.000A
MGT END     : 0.000A
MGT RATE    : 1.000A/S
PERS RATE   : 1.000A/S
LAST END    : 0.000A
PERSISTENCE: <OFF>
RUN
                                           STANDBY
    
```

When using a Persistence Switch, Automatic Mode simplifies superconducting magnet control. After the user defines initial parameters, Automatic Mode permits the MPS to use two different ramp rates and four time delays, and to manage the Persistence Switch Heater to change magnet current from its existing value to a new value automatically. Dithering is supported (see Paragraph 3.9).

Use the Cursor keys to move the line indicator up or down. Change parameters using any numeric entry mode, including the cursor.

MGT START: 0 to ±50.000 A (620), 0 to ±125.000 A (622), 0 to ±155.000 A (623), 0 to ±72.000 A (647)

Magnet Start Current. The current in the magnet in persistence prior to the automatic run. The MPS opens the persistence switch after it reaches this current and the user-specified delay expires.

MGT END: 0 to ±50.000 A (620), 0 to ±125.000 A (622), 0 to ±155.000 A (623), 0 to ±72.000 A (647)

Magnet End Current. The desired magnet current. To set a new current, move to the MGT END line and enter a new current, then move to the RUN line and toggle to activate Automatic Mode. The MPS automatically ramps to the new current, returns the magnet to persistence, then ramps MPS current back down to zero.

MGT RATE: 0 to ±99.999 A/sec

Magnet Ramp Rate. Rate in amperes per second that the MPS charges the magnet. Exceeding the maximum rated voltage or current ramp rate may damage the magnet. The user may configure the MPS to limit the charging voltage.

The magnet manufacturer supplies the inductance of the magnet, maximum ramp voltage, and maximum current ramp rate. The relationship for these parameters is given by the equation:

$$L \frac{di}{dt} < V_{\max}$$

where: L = magnet inductance in henrys,

di/dt = maximum magnet current ramp rate in amps/second,

V_{\max} = rated maximum magnet ramp voltage in volts.

To set the Magnet Ramp Rate for automatic PSH control, move to the MGT RATE line and enter a ramp rate less than the magnet's maximum ramp rate. Upon entering a new current set point, the magnet current ramps at the entered magnet ramp rate.

PERS RATE: 0 to ±99.999 A/sec

Persistence Switch Ramp Rate. Rate in amperes per second of the MPS when in Persistence Mode. The current is flowing in the Persistent Switch and the rate is chosen as such. To set the Persistence Switch Ramp Rate, move to the PERS RATE line and enter a persistence switch ramp rate less than the maximum allowed. This value is usually considerably higher than the magnet ramp rate as there is little inductance in the persistence switch.

LAST END:

The ending charge current from the last time the MPS charged the magnet. The MPS sets this field after it charges the magnet to the Magnet End value. Once it reaches Magnet End, the MPS sets the value of Last End equal to the value of Magnet End. The user cannot change the Last End value. The MPS stores it in non-volatile memory and remembers it even when the MPS is Off.

PERSISTENCE: <ON> or <OFF> (Read only)

Persistence Mode Status. If Persistence Mode is On, the PSH heater is Off. If it is Off, the PSH heater is On.

The persistent switch takes the superconducting magnet into and out of persistence mode.

To exit persistent mode, the MPS current ramps up to match the persistent current, and the persistent switch heater coil heats the switch until it becomes normal (non-superconducting). A delay allows magnet current to settle. Then the magnet current ramps to a new value.

To enter persistent mode, the MPS removes current from the persistent switch heater. After a delay to allow the switch to superconduct, the MPS current ramps down to 0 at a rate low enough to ensure the switch remains superconducting. The magnet current then circulates in the superconducting loop formed by the magnet and the persistent switch.

Note: To set PSH current see Chapter 6 Options And Accessories.

RUN ∇ :

Press either of the Data Entry up or down key to initiate Automatic Mode.

3.6 FUNCTION MENUS

The MPS uses a system of three Function Menus for setup. Function Menus 1 and 2 do not require a PSH Option Card, but the presence of one changes the look of the menus. The Function Menu 3 requires a PSH Option Card in order to display. Press **Function Menu** to display Function Menu 1. To choose a different menu, press **Next Menu**; Function Menu 2 displays. Each press of **Next Menu** displays the next menu. Pressing **Next Menu** with Function Menu 3 displayed returns to Function Menu 1. To exit a Function Menu, press **Function Menu**. To exit the menu system, press **Normal Display** or **Escape**. See Figure 3-1.

3.6.1 Function Menu 1

Function Menu 1 for an MPS with a PSH Option Card appears to the right. The 1/3 in the upper right corner indicates Menu 1 of 3. It has four selections: AUTOMATIC MODE/MANUAL MODE, INTERFACE SETUP, STEP LIMIT/ZERO and INSTR. SETUP.

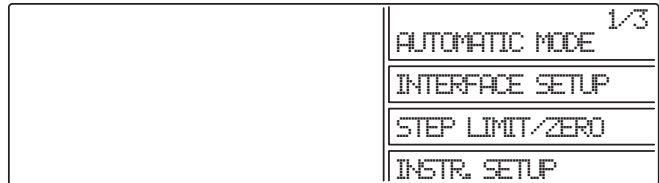

3.6.1.1 Automatic Mode / Manual Mode

AUTOMATIC MODE appears in the menu only on MPS units with a PSH Option Card installed and operating in MANUAL MODE. Without a PSH Option Card, this menu item is empty and a "1/2" appears in the upper right corner indicating menu 1 of 2. If the PSH option is installed, then the menu item toggles between MANUAL and AUTOMATIC PSH control. If the unit is in MANUAL MODE this menu item reads AUTOMATIC MODE and pressing the corresponding Display Function key places the MPS in AUTOMATIC PSH control mode. If the unit is in AUTOMATIC MODE, this menu item reads MANUAL MODE and pressing the corresponding Display Function key places the MPS in MANUAL PSH control mode.

3.6.1.2 Interface Setup Screen

Press the Function Menu key followed by the INTERFACE SETUP Function key to display setup screen to the right. Use the Cursor keys to move the line indicator up or down. Parameters with a # icon change with the Data Entry up or down key. Change all others using any numeric entry mode, including the cursor.

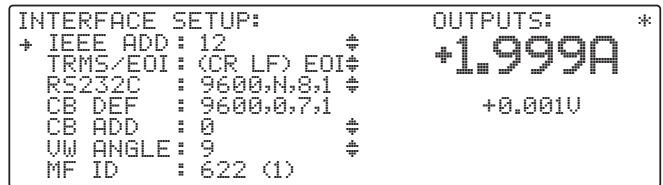

IEEE ADD: 1 to 30

Defines the IEEE Address. The default is 12.

TRMS/EOI: CR LF, LF CR, DAB, LF, with or without EOI

Choose from the following options: (CR LF) EOI, (LF CR) EOI, (DAB) EOI, (LF) EOI, (CR LF), (LF CR), (DAB), (LF). When EOI displays, End Or Identify (**EOI**) is asserted during the last byte of a multibyte transfer. The default is Carriage Return and Line Feed (CR LF) with EOI ON.

RS-232C: 1200,N,8,1

Select 300, 1200, or 9600 Baud. The other parameters are fixed at No Parity, 8 Data Bits, and 1 Stop Bit.

CB DEF: 9600,o,7,1 (Read only)

Control Bus Definition. Fixed at 9600 Baud, odd parity, 7 data bits, and 1 stop bit. See Appendix C.

CB ADD: 0 to 32

Control Bus Address. See Appendix C.

VW ANGLE: 2 to 9

Display viewing angle. 9 indicates viewing from above, 5 in the middle, and 2 from below. Initial value is 5.

MF ID: 620 (1), 622 (1), 623 (1), or 647 (1) (Read only)

MPS ID. A 1 indicates only one MPS. On the master MPS (MPS1) of a multiple MPS configuration, the number indicates the number of units connected in parallel. A slave MPS with a display in a multiple MPS configuration displays "S" (for slave) instead of a number. Polling at power up determines the number of units in parallel.

3.6.1.3 Step Limit/Zero Screen

Press the Function Menu key to display Function Menu 1. Press the STEP LIMIT/ZERO Function Key to display the Step Limit/Zero screen to the right. This screen combines two features: Current Step Limit and Current Zero.

```

CURRENT STEP LIMIT:      OUTPUTS: *
+STATUS : <OFF>          +1.999A
I STEP   : + 10.000A
ZERO:
STATUS   : <OFF>
I ZERO   : + 0.000A
I MODE   : EXTERNAL
    
```

Use the Cursor keys to move the line indicator up or down. Parameters with a \ddagger icon toggle with the Data Entry up or down key. Change all others using any numeric entry mode, including the cursor.

3.6.1.3.1 Current Step Limit

When a superconducting magnet quenches, the magnet becomes resistive. The output current forces the MPS output to the compliance voltage setting and the output current drops rapidly. To avoid excessive cryogen boil-off, the output current setting should be changed to 0 as quickly as possible. The output current step limit, if exceeded, automatically resets the output to 0 A. The Step Limit function also prevents the user from entering steps that exceed the current step limit.

STATUS: <OFF> or <ON>

Output Current Step Limit Status.

I STEP: + 0.010 A to + 999.99 A

Output Current Step Limit.

3.6.1.3.2 Current Zero

There may be configurations, like multiple auto-parallel MPS units, that introduce an output current offset from zero. This small offset current may result in high energy stored in the magnet load. The output current zero feature allows the user to zero this output current offset. The MPS stores the current zero value in non-volatile memory. Before accessing output current zero from the MPS front panel, enter a current of zero and allow the output current to settle to the offset value.

If the status is ON, toggle it OFF and allow current to settle, to clear the old value before entering a new value. When the status is toggled ON, the MPS stores the output current as the current zero and displays it as the I ZERO value.

3.6.1.4 Instrument Setup Screen

The Instrument Setup screen defines the major operating characteristics of the Normal Display. Press the Function Menu key to display Function Menu 1. Press the INSTR. SETUP Function key to display the Instrument Setup screen to the right. Use the Cursor keys to move the line indicator up or down. Parameters with a \ddagger icon toggle with the Data Entry up or down key. Change all others using any numeric entry mode, including the cursor.

```

INSTRUMENT SETUP:      OUTPUTS: *
+FLD ENABLE: <OFF>     +1.999A
B UNITS   :tesla(T)
tesla/A   :± 0.1000
IMAX SET  :±125.000A
COMPLIANCE:± 30.000V
    
```

NOTE: FLD ENABLE, B UNITS, and FIELD/A apply to superconducting magnets where there is a linear relationship between current and field. Do not confuse this with the Model 6226 Gaussmeter Card reading. This is a computed field directly related to the current by the constant entered on the fourth line.

FLD ENABLE: <ON> or <OFF>

Field Enable. Allows the user to change the Normal Display units from amps to field units. To change Normal Display units, move to the Field Enable line and toggle it ON. Move to the B UNITS (Field Units) line and toggle the units between kG or Tesla. Move the cursor to the kG/A or Tesla/A line and enter the magnet Field to Current ratio. Usually, the ratio is on the magnet data sheet. If not, call the magnet manufacturer. The MPS now sets and displays magnet field in the desired units. The Default is Field Enable OFF.

B UNITS: kG or tesla Define B Field Units in kilogauss (kG) or tesla. The Default is kG.

FIELD/A: kG/A or tesla/A

Magnet Field to Current ratio. Obtain this value from the magnet data sheet, or calculate it from magnet manufacturer information. The Default is 1.000 kG/A (0.1000 tesla/A).

IMAX SET: 0.00 A to +50.00 A (620), +125.00 A (622), +155.00 A (623), or +72.00 A (647)

Current Maximum Setting. MPS current cannot exceed this setting. The software allows no setting above these limits. The rated maximum magnet current is the current above which magnet damage may occur. Never exceed the rated maximum current.

IMAX is the maximum output current. ISET is the constant output current. The value for ISET cannot exceed the value for IMAX. For example, if the user sets IMAX to 1 A, the MPS limits any constant output current in excess of 1 A to 1 A. If the user increases IMAX to 10 A, and sets ISET to 1 A, the MPS still limits constant output current to 1 A, not 10 A. Changing ISET to 10 A allows a constant output current of 10 A, and so on.

To set IMAX, move to the IMAX SET line and enter the maximum current allowed for the magnet.

COMPLIANCE: 0.00 V to ± 5.00 V (620), ± 30.00 V (622 & 623), or ± 32.00 V (647)

Compliance Voltage Limit. The MPS cannot exceed the Compliance Voltage Limit of the given model.

Set the compliance voltage lower than the rated voltage of both the magnet and, if present, the magnet protection diodes. Determine these values from magnet manufacturer information. Once the user enters a Compliance voltage, the MPS retains it in non-volatile memory as the default value.

Some magnets come equipped with diodes across the magnet leads to protect the magnet in the event of a magnet quench or a ramp rate that produces a charging voltage that exceeds the rated voltage of the magnet. Set the MPS voltage limit to below the rated voltage of the protection diodes.

CAUTION: Never set the MPS voltage limit above the rated voltage of the magnet's built-in protection diodes. Doing so may result in damage to the magnet and/or its diodes.

If the magnet voltage reaches the MPS compliance voltage during charging, the MPS limits the ramp rate and holds the voltage at the compliance until the end of charging or until the ramp rate falls below:

$$\frac{V_{set}}{L} \text{ where } V_{set} = \text{MPS compliance voltage, and } L = \text{magnet inductance in henrys.}$$

The MPS automatically switches between operation as a current source and limitation by the compliance voltage. The MPS operates most smoothly as a current source. As such, current ramp rate is limited by:

$$\frac{di}{dt} < \frac{V_{set}}{L} \quad \text{where } \frac{di}{dt} = \text{max magnet current ramp rate in amperes/second, } V_{set} = \text{MPS compliance voltage, and } L = \text{magnet inductance in henrys.}$$

In a multiple MPS configuration, each MPS must operate in current mode. If one unit operates in compliance mode while the others operate in current mode, uneven distribution of the current load results.

Though compliance voltage is user-defined, if operation above safe diode voltage is a possibility, Lake Shore can limit the hardware output voltage range and OVP to a safe level for the magnet. Example: ±3 volts maximum output voltage limit with an OVP setting of ±7 to 9 volts (assuming this voltage is below the diode forward voltage at 4.2 K). Return the MPS to the factory for this hardware modification.

To set the compliance voltage, move to the COMPLIANCE line and enter a compliance voltage less than the maximum voltage for both the magnet and the magnet protection diodes.

Software also automatically limits MPS output power to 1000 VA (622 & 623) or 2000 VA (647) by adjusting the voltage. For example, if the user sets current to 0 amps and compliance to 30 volts, then changes current to 100 amps, the MPS software automatically sets compliance to 10 volts.

3.6.2 Function Menu 2 Screen

To display Function Menu 2 shown on the right, press the Function Menu key to display Menu 1, then the Next Menu key. The 2/3 in the upper right corner indicates Menu 2 of 3. Without a PSH Option Card, a "2/2" appears in the upper right corner indicating menu 2 of 2. With all options installed, Function Menu 2 has four possible selections:

	2/3
OUTPUTS ONLY	
LHe LEVEL	
FIELD	
PSH SETUP	

OUTPUTS ONLY, LHe LEVEL, FIELD and PSH SETUP . <NP> indicates the function is "Not Present" and the associated function key is ignored.

3.6.2.1 Outputs Only Screen

Press the OUTPUT ONLY Function key to display a screen with output values in larger characters for remote viewing. There are two screens: one with the LHe Level/Field Option, one without the LHe Level/Field Option.

3.6.2.2 LHe Level

Enters the Liquid Helium (LHe) Level screen. See Paragraph 6.2 for a detailed description.

3.6.2.3 Field

Enters the Field screen. See Paragraph 6.2 for a detailed description.

3.6.2.4 PSH Setup

Enters the Persistent Switch Heater (PSH) screen. See Paragraph 6.3 for a detailed description.

Outputs Only Screen without LHe Level/Field Option

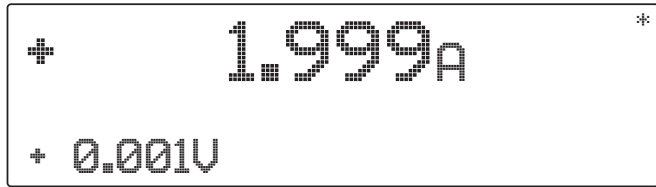

Outputs Only Screen with LHe Level/Field Option

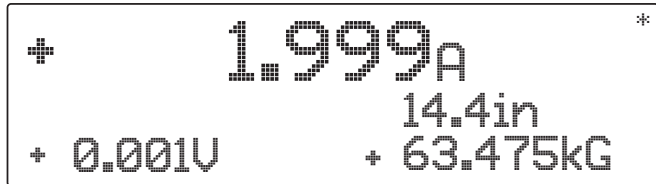

3.6.3 FUNCTION MENU 3 SCREEN (PSH Option Card ONLY)

To display Function Menu 3 shown on the right, press the Function Menu key, then press the Next Menu key twice. Function Menu 3 has one selection: DELAYS.

NOTE: The Delay Screen functions only with the PSH option. Without the PSH, Function Menu 3 will not appear.



3.6.3.1 Delays Setup Screen

Select DELAYS using the Function key to display the Delays screen. Here, the user programs four delays associated with Automatic Mode.

RUN UP

The time between initial ramp up to current and PSH activation (Persistence Mode OFF). The delay allows persistence switch current to settle. Specify a time from 1 to 999 seconds. Default is 60 seconds.

PERS OFF

The time between PSH activation (Persistence Mode OFF) and initial ramp to setpoint. The delay allows persistence switch to go normal. Specify a time from 1 to 999 seconds. Default is 60 seconds.

RAMP END

The time between ramp up to setpoint and PSH deactivation (Persistence Mode ON). The delay allows magnet current to settle. Specify a time from 1 to 999 seconds. Default is 60 seconds.

PERS ON

The time between PSH deactivation (Persistence Mode ON) and initial ramp back to zero. The delay allows the persistence switch to superconduct. Specify a time from 1 to 999 seconds. Default is 60 seconds.

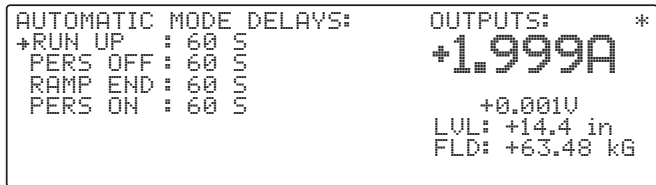

3.6.3.2 DELAY SETUP SCREEN WITH DITHERING

To access the dithering feature, turn ON (up position) switch 5 of the rear panel **CAL AND ID** DIP switches. Select **DELAY/DITHER** from Function Menu 3 to display the **AUTOMATIC MODE DELAY** screen to the right.

```

AUTOMATIC MODE DELAYS:      OUTPUTS: *
+RUN UP : 60 S              +1.999A
PERS OFF : 60 S
RAMP END : 60 S
PERS ON : 60 S
DITHER : 60 S
DITHER : +0.50%
DITHER : <OFF>
    
```

DITHER : XX S

The dwell in seconds for each of five dithering excursions from the desired Magnet End Current. Default = 60 seconds.

DITHER : + X.XX%

The maximum dither excursion from the Magnet End Current in percent. Default = 0.5%.

DITHER : <OFF>

To enable dithering, this must read **<ON>**. Move the cursor to the last line using the Up/Down cursor keys. Press either the Data Entry up or down key to toggle the Dither Feature on and off. Default is off.

3.7 MANUAL PERSISTENCE CONTROL EXAMPLE

Assume the magnet is in persistence with a current of 20 amperes. It is desired to change the magnet current to 30 amperes and return to persistence mode.

Connect the MPS to the magnet and the PSH heater terminals to the persistence switch. Turn on the MPS and set the PSH heater current to the desired current. See Paragraph 6.3.2 to set heater current. The Normal manual screen displays (see Paragraph 3.3).

First, ramp the MPS to the value of current in the magnet. Actually, MPS current flows in the persistence switch, not the magnet. As MPS current increases, the persistence switch current decreases eventually to zero. Select a suitable ramp rate for current in the persistence switch, enable the ramp if not enabled, and enter 20 amperes into the setpoint setting. The MPS ramps to 20 amperes. After settling, the MPS current equals the magnet current, with zero current in the persistence switch.

Using the cursor keys, move to the last line **PERSISTENCE: <ON>** and press a Data Entry up or down arrow. The heater turns on, and the **<ON>** changes to **<OFF>**. If it does not change, check the heater wiring and/or heater current specified. If an error message ****OUT OF CMPL**** appears, then the heater power supply is at its voltage limit. If so, check the wiring, and/or change the heater current.

At this point, the MPS and magnet currents are 20 amperes. Select a suitable ramp rate for current in the magnet and enter the desired current (30 amperes) into the setpoint setting. The MPS and magnet current ramp to 30 amperes.

Using the cursor keys, move to the last line **PERSISTENCE: <ON>** and press a Data Entry up or down arrow. The heater turns off, and the **<OFF>** changes to **<ON>**.

Now ramp the MPS to zero current. The magnet is in persistence at 30 amperes. Figure 3-2 illustrates the process just described. The same process can be done automatically. See Paragraphs 3.5, 3.8.

3.8 AUTOMATIC PERSISTENCE CONTROL EXAMPLE

1. Enter the Instrument Setup screen and set the Compliance voltage limit which the MPS cannot exceed. See magnet manufacturer information to determine this value. Once set, the MPS retains the value in non-volatile memory as the default value. Return to the Automatic Mode display.

```

INSTRUMENT SETUP:          OUTPUTS: *
+FLD ENABLE: <OFF>        +1.999A
B UNITS      :tesla(T)
tesla/A      :± 0.1000
IMAX SET     :±125.000A
COMPLIANCE  :± 30.000V
    
```

2. Enter these parameters in the Automatic Mode Screen:

MAG START: Magnet Start Current (only if LAST END is unknown). For this example, we assume an initial MPS hook-up to this magnet and a previous magnet charge to 20 A.

```

AUTOMATIC MODE:          OUTPUTS: *
+MGT START : 0.000A      +0.000A
MGT END    : 0.000A
MGT RATE   : 1.000A/S    +0.001V
PERS RATE  : 1.000A/S
LAST END   : 0.000A
PERSISTENCE: <OFF>
RUN  $\Phi$                 STANDBY
    
```

MGT END: Magnet End Current. Enter 30 A.

MGT RATE: Magnet Charging Rate. Base this figure on the maximum magnet current supplied by the magnet manufacturer. For this example, enter 0.4 A/S (amperes per second).

PERS RATE: Persistence Switch Charging Rate. Base this figure on the maximum Persistence Switch current (generally much higher than the magnet charging rate). Anything over approximately 20 A/S appears instantaneous. For this example, enter 4 A/S.

3. Enter the following parameters in the Automatic Delay Screen (Function Menu 3).

RUN UP: The time between initial ramp up to current and PSH activation (Persistence Mode OFF). Enter 5 seconds.

```

AUTOMATIC MODE DELAYS:  OUTPUTS: *
+RUN UP   : 60 S        +1.999A
PERS OFF  : 60 S
RAMP END  : 60 S
PERS ON   : 60 S
                                +0.001V
                                LVL: +14.4 in
                                FLD: +63.48 KG
    
```

PERS OFF: The time between PSH activation (Persistence Mode OFF) and initial ramp to setpoint. Enter 5 seconds.

RAMP END: The time between ramp up to setpoint and PSH deactivation (Persistence Mode ON). Enter 5 seconds.

PERS ON: The time between PSH deactivation (Persistence Mode ON) and initial ramp back to zero. Enter 5 seconds.

4. Return to the Automatic Mode Screen. Move to the RUN line, then toggle to activate Automatic Mode. The MPS automatically runs through the cycle as defined, providing messages on the bottom line of the display to detail the current step of the cycle. When complete, the display returns to STANDBY.

After determining proper system Delay times, it is unnecessary to visit the Delay Screen each time; the delays store in non-volatile memory. After the MPS completes the cycle once, it stores the ending current value to LAST END. To make subsequent changes to magnet current simply enter a new MGT END setpoint.

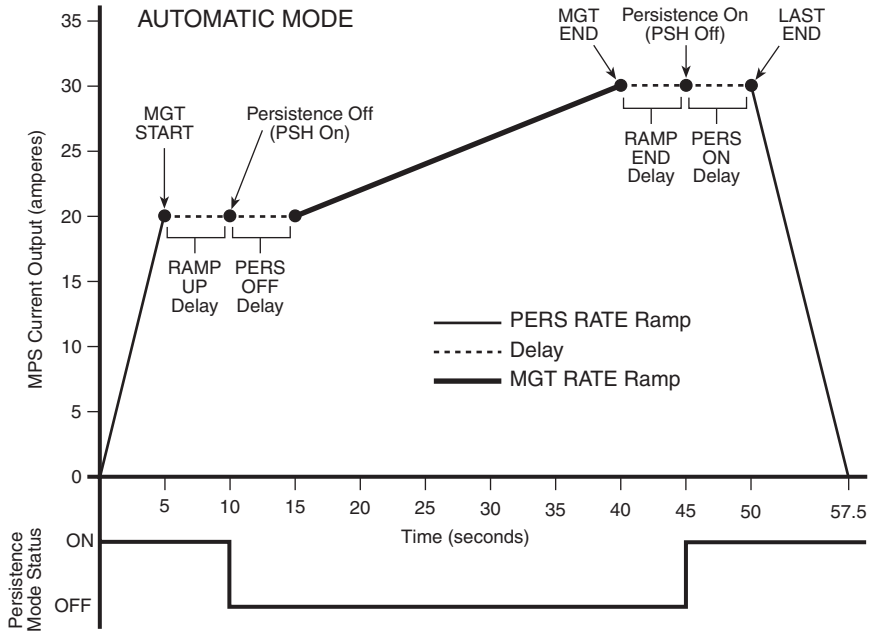

Figure 3-2 Typical Automatic Mode Cycle

To pause a ramp or skip a time out, press either the Data Entry up or down key. To abort the operation, press **Escape**. After an abort, **<RUN>** continues an automatic process from where it left off.

3.9 DITHERING IN AUTOMATIC MODE

Dithering is a means of arriving at the magnet current by executing excursions around the final current which decay to zero in a specified dwell (delay) time.

For example, suppose the final magnet current (MGT END) is 100 amperes, the maximum dither is 0.5%, and the Dither Delay is 30 seconds. The operation in the Automatic Mode proceeds the same as in Paragraph 3.8 up to the time that the magnet current ramps. The current in the magnet ramps to $100 * (1 + 0.005) = 100.5$ amperes, which is 0.5% above the final magnet current. When the current reaches 100.5 amperes, it dwells for 30 seconds at that current. After the 30 seconds, the current ramps at the MGT RATE to $100 * (1 - .0025) = 99.75$ amperes, that is, half of the 0.5% in the opposite direction. The 30 second dwell begins when the current reaches 99.75 amperes. The process continues at $100 * (1 + 0.00125) = 100.125$ amperes, then $100 * (1 - 0.000625) = 99.9375$ amperes, then $100 * (1 + 0.0003125) = 100.031$ amperes, and finally 100 amperes.

To access the dithering feature, turn ON (up position) switch 5 of the rear panel **CAL AND ID** DIP switches. Select **DELAY/DITHER** from Function Menu 3 to display the **AUTOMATIC MODE DELAY** screen shown to the right.

```

AUTOMATIC MODE DELAYS:      OUTPUTS: *
+RUN UP   : 60 S           +0.000A
PERS OFF  : 60 S           +0.000V
RAMP END  : 60 S
PERS ON   : 60 S
DITHER   : 60 S
DITHER   : +0.50%
DITHER   : <OFF>
    
```

To enable dithering, move the cursor to the last line using the Up/Down cursor keys. Press either the Data Entry up or down key to toggle the Dither Feature on and off. Default is off. For our example, the DITHER (delay) changes to 30 S from the default 60 S. The dither of 0.5% is the default. If a Dither of 1% were entered, the process would produce 1% over the MGT END, then -0.5% under, +0.25% over, -0.125% under, 0.0625% over and finally the MGT END selected.

```

AUTOMATIC MODE:             OUTPUTS: *
+MGT START :+ 10.000A       +100.500A
MGT ENG    :+100.000A
MGT RATE   :+ 1.000A       +0.001V
PERS RATE  :+ 1.000A
LAST END   :+ 10.000A
PERSISTENCE: <OFF>        20
<DITHER = 0.05%>         ⇄ TO SKIP
    
```

The last line of the Automatic Mode screen shows the stage of the dithering. The screen above indicates the first current of the dithering at 0.5% above the 100 amperes with 20 seconds left in the Dither delay. Press either the Data Entry up or down key to skip the delay and ramp immediately to the next current in the dither.

This Page Intentionally Left Blank.

CHAPTER 4

REMOTE OPERATION

4.0. GENERAL

Either of two computer interfaces on the optional 6224 card permit remote MPS operation: the IEEE-488 Interface (Paragraph 4.1) and the Serial Interface (Paragraph 4.2). Use only one of the interfaces at a time. The two interfaces share a common set of commands described in Paragraph 4.3. For further information on RS-485 Mainframe Control Bus Operation, see Appendix C.

4.1. IEEE-488 INTERFACE

The IEEE-488 Interface is an instrumentation bus with hardware and programming standards that simplify instrument interfacing. The MPS IEEE-488 Interface complies with the IEEE-488.2-1987 standard and incorporates the functional, electrical, and mechanical specifications of the standard unless otherwise specified in this manual.

All instruments on the interface bus perform one or more of the interface functions of TALKER, LISTENER, or BUS CONTROLLER. A TALKER transmits data onto the bus to other devices. A LISTENER receives data from other devices through the bus. The BUS CONTROLLER designates to the devices on the bus which function to perform. The MPS performs the functions of TALKER and LISTENER but cannot be a BUS CONTROLLER. The BUS CONTROLLER is the digital computer which tells the MPS which functions to perform.

Below are MPS IEEE-488 interface capabilities:

- **SH1:** Source handshake capability
- **RL1:** Complete remote/local capability
- **DC1:** Full device clear capability
- **DT0:** No device trigger capability
- **C0:** No system controller capability
- **T5:** Basic TALKER, serial poll capability, talk only, unaddressed to talk if addressed to listen
- **L4:** Basic LISTENER, unaddressed to listen if addressed to talk
- **SR1:** Service request capability
- **AH1:** Acceptor handshake capability
- **PP0:** No parallel poll capability

4.1.1 IEEE-488 Interface Settings

To use the IEEE-488 interface, the user must set the IEEE Address and Terminators. Press the **Function Menu** key, then press the key corresponding to **INTERFACE SETUP** to display the Interface Setup screen. Use the cursor keys to move the arrow indicator to IEEE ADD and TRMS/EOI.

```

INTERFACE SETUP:
+ IEEE ADD : 12
TRMS/EOI : (CR LF) EOI
RS232C : 9600,N,8,1
CB DEF : 9600,0,7,1
CB ADD : 0
VW ANGLE : 9
MF ID : 622 (1)

OUTPUTS: *
+1.999A
+0.001V
    
```

IEEE ADD: 1 to 30

Use the Data Entry up or down arrows to increment or decrement the IEEE Address. The default value is 12. The range of choices is from 1 to 30.

TRMS/EOI: CR LF, LF CR, DAB, LF, with or without EOI

Use the Data Entry up or down arrows to cycle through the following choices: (CR LF) EOI, (LF CR) EOI, (DAB) EOI, (LF) EOI, (CR LF), (LF CR), (DAB), (LF). If turned on, End Or Identify (**EOI**) is asserted during the last byte of a multibyte transfer. The default is Carriage Return and Line Feed (CR LF) with EOI ON.

4.1.2 IEEE-488 Command Structure

The Model 622/623 supports several command types. There are three groups of commands:

1. Bus Control – see Paragraph 4.1.2.1.
 - a. Universal
 - (1) Uniline
 - (2) Multiline
 - b. Addressed Bus Control
2. Common – see Paragraph 4.1.2.2.
3. Interface and Device Specific – see Paragraph 4.1.2.3.

4.1.2.1 Bus Control Commands

A Universal Command addresses all devices on the bus. Universal Commands include Uniline and Multiline Commands. A Uniline Command (Message) asserts only a single signal line. The MPS recognizes two of these messages from the BUS CONTROLLER: **Remote (REN)** and **Interface Clear (IFC)**. The MPS sends one Uniline Command: **Service Request (SRQ)**.

REN (Remote) – Puts the MPS into remote mode.

IFC (Interface Clear) – Stops current operation on the bus.

SRQ (Service Request) – Tells the bus controller that the MPS needs interface service.

A Multiline Command asserts a group of signal lines. All devices equipped to implement such commands do so simultaneously upon command transmission. These commands transmit with the Attention (ATN) line asserted low. There are two Multiline commands recognized by the MPS:

LLO (Local Lockout) – Prevents the use of instrument front panel controls.

DCL (Device Clear) – Clears MPS interface activity and puts it into a bus idle state.

Finally, Addressed Bus Control Commands are Multiline commands that must include the MPS listen address before the instrument responds. Only the addressed device responds to these commands. The MPS recognizes three of the Addressed Bus Control Commands:

SDC (Selective Device Clear) – The SDC command performs essentially the same function as the DCL command except that only the addressed device responds.

GTL (Go To Local) – The GTL command is used to remove instruments from the remote mode. With some instruments, GTL also unlocks front panel controls if they were previously locked out with the LLO command.

SPE (Serial Poll Enable) and **SPD (Serial Poll Disable)** – Serial polling accesses the Service Request (SRQ) Status Register. This status register contains important operational information from the unit requesting service. The SPD command ends the polling sequence.

4.1.2.2 Common Commands

Common Commands are addressed commands which create commonality between instruments on the bus. All instruments that comply with the IEEE-488 1987 standard share these commands and their format. Common commands all begin with an asterisk. They generally relate to “bus” and “instrument” status and identification. Common query commands end with a question mark (?). See Paragraph 4.3 for a complete listing of all MPS common commands.

4.1.2.3 Interface and Device Specific Commands

Device Specific Commands are addressed commands. The MPS supports a variety of Device Specific commands to program instruments remotely from a digital computer and to transfer measurements to the computer. Most Device Specific Commands perform functions also performed from the front panel. This section discusses Common and Device Specific commands. Device Specific Commands consist of Interface, Display, Channel, Control Process and Curve commands. See Paragraph 4.3 for a complete listing of all MPS interface and device specific commands.

4.1.3 Status Registers

There are two status registers: the Status Byte Register (Paragraph 4.1.3.1), and the Standard Event Status Register (Paragraph 4.1.3.2).

4.1.3.1 Status Byte and Service Request Enable Registers

The Status Byte Register consists of a single data byte containing seven bits of MPS status information.

STATUS BYTE REGISTER FORMAT

7	6	5	4	3	2	1	0	Bit
128	64	32	16	8	4	2	1	Weighting
SDR	SRQ	ESB	OVP	ERR	RSC	LIM	ODR	Bit Name

If the Service Request is enabled, any bits that are set cause the MPS to pull the SRQ management low to signal the BUS CONTROLLER. **These bits reset to zero upon a serial poll of the Status Byte Register.**

The Service Request Enable Register inhibits or enables any of the status reports in the Status Byte Register. The *SRE command sets the bits. A bit that is set enables its function. Inhibit these reports by turning OFF their corresponding bits in the Service Request Enable Register. Refer to the *SRE discussion.

Setting Data Ready (SDR) Bit (7). When set, the MPS resets current and voltage to 0 A and 1 V because of OVP or RI activity.

Service Request (SRQ) Bit (6). Determines whether the MPS is to report via the SRQ line and five bits determine which status reports to make. If bits 0, 1, 2, 3, 4 and/or 5 are set, then the corresponding bit in the Status Byte Register is set. The MPS produces a service request only if bit 6 of the Service Request Enable Register is set. If disabled, the Status Byte Register can still be read by the BUS CONTROLLER by means of a serial poll (SPE) to examine the status reports, but the Service Request does not interrupt the BUS CONTROLLER. The *STB common query reads the Status Byte Register but does not clear the bits. Certain bits in the Status Byte Register continually change. Above are bit assignments in the Status Byte Register. These reports occur only if the bits are enabled in the Service Request Enable Register.

Event Status (ESB) Bit (5). When set, it indicates if one of the bits from the Standard Event Status Register has been set. (Refer to Paragraph 4.1.4.2.)

Overvoltage Protection (OVP) Bit (4) Indicates overvoltage (quench) protection circuit activation.

Error (ERR) Bit (3). Indicates operation error. The error displays on the front panel and can be read using the *TST? Command.

Ramp Segment Complete (RSC) Bit (2). Indicates active ramp segment completion.

Limit Exceeded (LIM) Bit (1). Indicates a new current or voltage exceeds the current or compliance voltage limit. Read the new setting with the ISET? or VSET? commands.

Output Data Ready (ODR) Bit (0). When set, makes current and voltage readings available.

4.1.3.2 Standard Event Status and Standard Event Status Enable Registers

The Standard Event Status Register supplies various conditions of the instrument.

STANDARD EVENT STATUS REGISTER FORMAT

7	6	5	4	3	2	1	0	Bit
128	64	32	16	8	4	2	1	Weighting
PON	not used	CME	EXE	DDE	QYE	not used	OPC	Bit Name

Bits 2 and 6 are not used. The reports of this register occur only if the bits are enabled in the Standard Event Status Enable Register along with bit 5 of the Service Request Enable Register.

The Standard Event Status Enable Register enables any of the Standard Event Status Register reports. The Standard Event Status Enable command (***ESE**) sets the Standard Event Status Enable Register bits. Set a bit to enable its function. To set a bit, send the *ESE command with the bit weighting for each bit to set added together. See the *ESE command for further details.

The Standard Event Status Enable Query, ***ESE?**, reads the Standard Event Status Enable Register. ***ESR?** reads the Standard Event Status Register. Once this register is read, all bits are reset to zero.

Power On (PON) Bit (7). This bit is set when the power cycles from OFF to ON.

Command Error (CME) Bit (5). Set upon detection of a command error since the last reading. This means the instrument could not interpret the command due to a syntax error, unrecognized header, unrecognized terminators, or unsupported command.

Execution Error (EXE) Bit (4). Set upon detection of an execution error. Occurs when the instrument is instructed to do something outside its capabilities.

Device Dependent Error (DDE) Bit (3). Reserved for future use.

Query Error (QYE) Bit (2). Indicates a query error. Occurs rarely and involves loss of data due to a full output queue.

Operation Complete (OPC) Bit (0). Generated in response to the *OPC (operation complete) common command. It indicates MPS completion of all selected pending operations.

4.1.4 Example IEEE Setup and Program

Below is an example of how to setup and run a simple program using the built-in MPS IEEE-488 Interface. It does not reflect every hardware/software configuration found in the field. This example uses the National Instruments GPIB - PCII/IIA card and QuickBasic 4.0 or 4.5 on a PC compatible.

4.1.4.1 GPIB Board Installation

Use the following procedure to install the GPIB Board.

1. Install GPIB-PCII/IIA card using National Instruments instructions.
2. Install NI - 488.2 software (for DOS). Version 2.1.1 was used for the example.
3. Verify that config.sys contains the command: device = C:\GPIB.COM
4. Reboot the computer.
5. Run IBTEST to test software configuration. Do not install the instrument before running IBTEST.
6. Run IBCONF to configure the GPIB - PCII/IIA board and dev 12. Set the EOS byte to 0AH. See setup in Fig 4-1. IBCONF modifies gpib.com.
7. Connect the instrument to the interface board and power up the instrument. Verify the address as 12 and the terminators as CR LF.

4.1.4.2 Run The Example QuickBasic Program

Use the following procedure to run the QuickBasic Program.

1. Copy c:\gpib-pc\Qbasic\qbib.obj to the QuickBasic directory (QB4).
2. Change to the QuickBasic directory and type: `link /q qbib.obj, , , bq1b4x.lib` where x = 0 for QB4.0 and 5 for QB4.5 This one-time only command produces the library file qbib.qlb. The procedure is found in the National Instruments QuickBasic readme file Readme.qb.
3. Start QuickBasic. Type: `qb /1 qbib.qlb`. Start QuickBasic in this way each time the IEEE interface is used to link in the library file.
4. Create the IEEE example interface program in QuickBasic. See Table 4-1. Name the file "ieeeeexam.bas" and save.
5. Run the program.

4.1.5 Notes On Using the IEEE Interface

- The term "free field" indicates a floating decimal point that may be placed any appropriate place in the string of digits.
- **[term]** indicates where the user places terminating characters or where they appear on a returning character string from the MPS.
- To chain commands together, insert a semi-colon, comma, or blank space between them. Some programming languages allow only blank spaces to chain. Multiple queries cannot be chained. The MPS responds to the last query entered when addressed as a talker.
- Queries generally use the same syntax as an associated setting command followed by a question mark. They most often return the same information that is sent. Some queries have no command form.
- Leading zeros and zeros following a decimal point are unneeded in a command string, but they are sent in response to a query. A leading "+" is not required, but a leading "-" is required.
- As characters are received over the interface, they store in a buffer with a length of 95 characters. After receiving the terminators, any new parameters are stored. The Mainframe requires about 100 msec to store new parameters before receiving any new commands.
- The Mainframe implements new parameters and updates measurement data once per 500 msec operation cycle (noted by the blinking asterisk to the left of the mode status). Sending new parameters or requesting data at a rate faster than 2 Hz is not recommended.

Table 4-1 Sample BASIC IEEE-488 Interface Program

```

' IEEEEEXAM.BAS      EXAMPLE PROGRAM FOR IEEE-488 INTERFACE
'
' This program works with QuickBasic 4.0/4.5 on an IBM PC or compatible.
'
' The example requires a properly configured National Instruments GPIB-PC2 card. The REM
' $INCLUDE statement is necessary along with a correct path to the file QBDECL.BAS.
' CONFIG.SYS must call GPIB.COM created by IBCONF.EXE prior to running Basic. There must
' be QBIB.QBL library in the QuickBasic Directory and QuickBasic must start with a link
' to it. All instrument settings are assumed to be defaults: Address 12, Terminators
' <CR> <LF>, and EOI active.
'
' To use, type an instrument command or query at the prompt. The command transmits to the
' instrument and the MPS receives and displays the response. If no query is sent, the
' instrument responds to the last query received. Type "EXIT" to exit the program. NOTE: The
' INPUT instruction accepts no commas as part of an input string. If a comma appears in an
' instrument command, replace it with a space.
'
'      REM $INCLUDE: 'c:\gpib-pc\qbasic\qbdecl.bas      'Link to IEEE calls
'      CLS                                           'Clear screen
'      PRINT "IEEE-488 COMMUNICATION PROGRAM"
'      PRINT
'
'      CALL IBFIND("dev12", DEV12%)                 'Open communication at address 12
'      TERM$ = CHR$(13) + CHR$(10)                  'Terminators are <CR><LF>
'
' LOOP2: IN$ = SPACE$(2000)                          'Clear for return string
'
'      INPUT "ENTER COMMAND (or EXIT):"; CMD$      'Get command from keyboard
'      CMD$ = UCASE$(CMD$)                          'Change input to upper case
'      IF CMD$ = "EXIT" THEN END                    'Get out on Exit
'      CMD$ = CMD$ + TERM$
'
'      CALL IBWRT(DEV12%, CMD$)                     'Send command to instrument
'
'      CALL IBRD(DEV12%, IN$)                       'Get data back each time
'
'      ENDTEST = INSTR(IN$, CHR$(13))               'Test for returned string
'      IF ENDTEST > 0 THEN                          'String is present if <CR> is seen
'          IN$ = MID$(IN$, 1, ENDTEST - 1)          'Strip off terminators
'          PRINT "RESPONSE:", IN$                  'Print return string
'      ELSE
'          PRINT "NO RESPONSE"                      'No string present if timeout
'      END IF
'      GOTO LOOP2                                   'Get next command

```

National Instruments	GPIB0 Configuration	GPIB-PC2/2A Ver 2.1
Primary GPIB Address→0	↑ ↓	Select the primary GPIB address by using the left and right arrow keys.
Secondary GPIB AddressNONE		This address is used to compute the talk and listen addresses which identify the board or device on the GPIB. Valid primary addresses range from 0 to 30 (00H to 1EH).
Timeout setting.....10sec		* Adding 32 to the primary address forms the Listen Address (LA).
Terminate Read on EOSYes		* Adding 64 to the primary address forms the Talk Address (TA).
Set EOI with EOS on WritesYes		EXAMPLE: Selecting a primary address of 10 yields the following:
Type of compare on EOS7-Bit		10 + 32 = 42 (Listen address)
EOS byte0Ah		10 + 64 = 74 (Talk address)
Send EOI at end of WriteYes		
System Controller.....Yes		
Assert REN when SCNo		
Enable Auto Serial Polling.....No		
Enable CIC Protocol.....No		
Bus Timing500nsec		
Parallel Poll Duration.....Default		
Use this GPIB board.....Yes		
Board Type.....PCII		
Base I/O Address02B8h		
F1: Help F6: Reset Value F9/Esc: Return to Map Ctl PgUp/PgDn: Next/Prev Board		

National Instruments	DEV12 Configuration	GPIB-PC2/2A Ver 2.1
Primary GPIB Address→0	↑ ↓	Select the primary GPIB address by using the left and right arrow keys.
Secondary GPIB AddressNONE		This address is used to compute the talk and listen addresses which identify the board or device on the GPIB. Valid primary addresses range from 0 to 30 (00H to 1EH).
Timeout setting.....10sec		* Adding 32 to the primary address forms the Listen Address (LA).
Terminate Read on EOSYes		* Adding 64 to the primary address forms the Talk Address (TA).
Set EOI with EOS on WritesYes		EXAMPLE: Selecting a primary address of 10 yields the following:
Type of compare on EOS7-Bit		10 + 32 = 42 (Listen address)
EOS byte0Ah		10 + 64 = 74 (Talk address)
Send EOI at end of WriteYes		
Enable Repeat AddressingYes		
F1: Help F6: Reset Value F9/Esc: Return to Map Ctl PgUp/PgDn: Next/Prev Board		

Figure 4-1 Typical National Instruments GPIB Configuration from IBCONF.EXE

4.2 SERIAL I/O INTERFACE

RS-232C is a standard of the Electronics Industries Association (EIA) and one of the most common interfaces between a computer and electronic equipment. The Customer supplied computer must have a Serial Interface port. The MPS Serial Interface complies with the electrical format of the RS-232C Interface Standard. A Serial Interface between the computer and the MPS permits remote monitoring and control of MPS control functions, which in turn controls MPS operation. See Figure 4-2.

The Serial Interface can both transmit and receive information. In transmit (Tx) mode, the instrument converts parallel information to serial and sends it over a cable up to 50 feet long (or longer with proper shielding). In receive (Rx) mode, the instrument converts serial information back to parallel for processing.

See Paragraph 4.2.1 for Serial Interface hardware configuration and adapters, Paragraph 4.2.2 for Serial Interface settings, and Paragraph 4.2.3 for a sample BASIC program to establish communications between the computer and the MPS.

The Serial Interface shares Device Specific commands with the IEEE-488 interface listed in Paragraph 4.3. However, without the advantage of the IEEE-488 Architecture, there are several limitations:

- The *OPC and *RST Common Commands are not supported.
- The END Bus Control Command is not supported.
- Terminators are fixed to CRLF.
- A query must be added to the end of a command string if the MPS must return information. (Over IEEE-488, the last query response is sent when addressed to talk.) For example: "ISET 10;ISET?" would set the output current to 10 A and immediately query the output current setting.

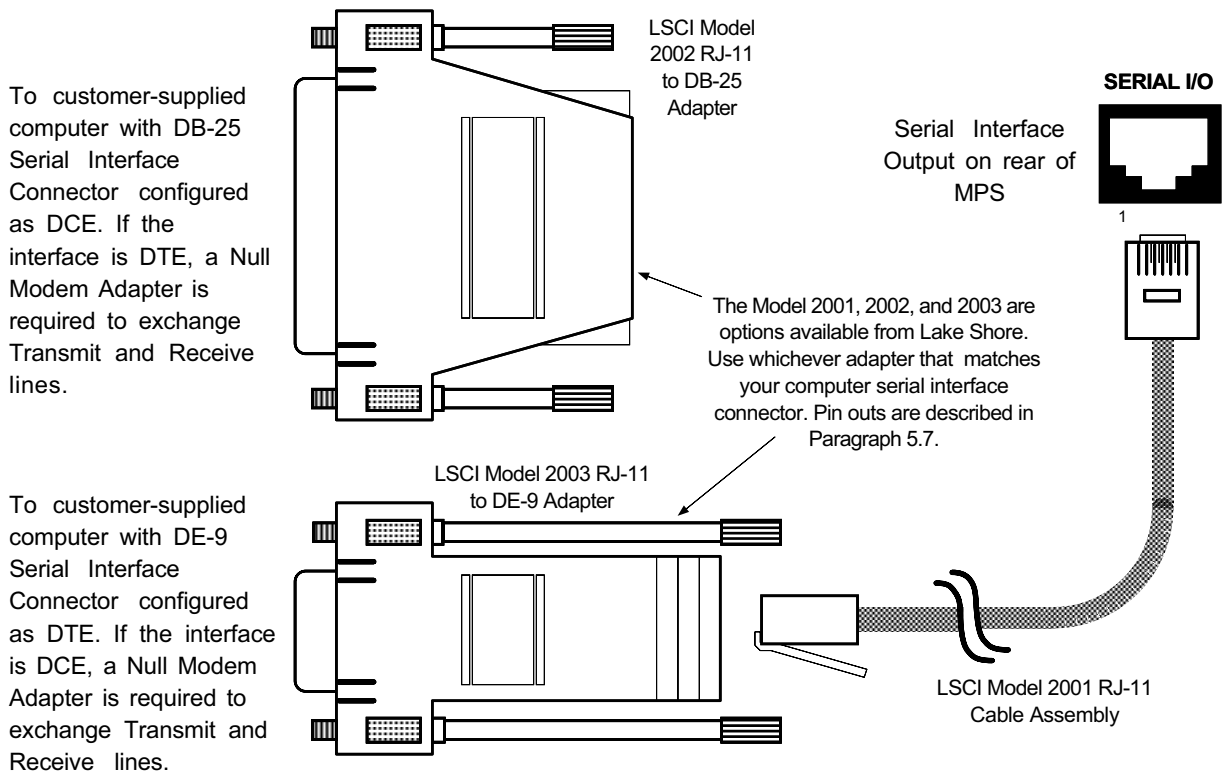

C-MPS-4-2.eps

Figure 4-2. Serial Interface Adapters

4.2.1 Serial Interface Hardware Configuration

Below is a technical description of the 6224 option card for the Serial Interface configuration. (**Note:** See Appendix C for Serial Interface on CMP.) Table 4.2 defines communication parameters. Terminators are fixed to Carriage Return (CR) and Line Feed (LF).

The serial interface connector is a standard 6-wire RJ-11 (telephone) jack. Lake Shore offers the Model 2001 10-foot Cable Assembly, Model 2002 RJ-11 to DB-25 Adapter, and the Model 2003 RJ-11 to DE-9 Adapter. See Chapter 5 for Serial I/O connector and adapter pinouts, and for RJ-11 pinouts. See Paragraph 5.7 for adapter wiring.

Table 4-2 Serial Interface Specifications

Transmission: Three-Wire	Bits per Character: 1 Start, 8 Data, 1 Stop
Baud Rate: 300, 1200 or 9600	Timing Format: Asynchronous
Parity Type: None	Connector: Two RJ-11 Modular Socket
Fixed Terminator: CR (0DH) LF (0AH)	Transmission Mode: Half Duplex
Data Interface Levels: Transmits & Receives Using EIA Voltage Levels	

4.2.2 Serial Interface Settings

To use the Serial Interface, set the Baud rate. Press the **Function Menu** key, then press the function key corresponding to **INTERFACE SETUP** to display the screen to the right. Use the cursor keys to move the arrow indicator to **RS232C**. Press the Data Entry up or down arrows to cycle between 300, 1200, or 9600 Baud. The remainder of the parameters are fixed at No Parity, 8 Data Bits, and 1 Stop Bit.

```

INTERFACE SETUP:          OUTPUTS: *
+ IEEE ADD : 12          +1.999A
TRMS/EOI : (CR LF) EOI
RS232C : 9600,N,8,1
CB DEF : 9600,0,7,1      +0.001V
CB ADD : 0
VW ANGLE : 9
MF ID : 622 (1)
    
```

4.2.3 Sample BASIC Serial Interface Program

The QuickBASIC V4.0 program in Table 4.3 is a sample interactive serial poll routine for the MPS Serial Interface. Below are typical examples using this BASIC program. (User input is in **bold type**.)

ENTER COMMAND? *IDN?	Identification Query. Returns manufacturer, model number, 0, and Firmware Date.
LSCI, 622, 0, 120193	
ENTER COMMAND? ISET 25; IOUT?	Output Current Setting and Query. Instructs unit to set current to 25 amps and then asks for current reading.
+24.9975A	
ENTER COMMAND? OVP?	Overvoltage (Quench) Protection Circuit Status Query. Unit returns setting, where 0 = Off and 1 = On.
0	
ENTER COMMAND? RI?	Remote Inhibit Status Query. Unit returns setting, where 0 = Inactive and 1 = Active.
0	
ENTER COMMAND? MODE?	Mode Status Query. Instrument returns mode, where 0 = Local, 1 = Remote, or 2 = Remote with Lockout.
1	

4.2.4 Notes On Using The Serial Interface

- To chain commands together, insert a semi-colon (;) between them. Multiple queries cannot be chained.
- Queries use the same syntax as the associated setting command followed by a question mark (?). They usually return the same information that is sent.
- Add a query to the end of a command string if the controller must return information. For example, RMP 0;RMP? commands the MPS to pause the ramp then return the ramp status to confirm the change.
- The MPS returns nothing queries without a "?" and ignores misspelled commands and queries.
- The term "**free field**" indicates a floating decimal point that can be placed at any appropriate place in the string of digits.
- Leading zeros and zeros following a decimal point are unneeded in a command string, but they are sent in response to a query. A leading "+" is not required, but a leading "-" is required.
- **[term]** indicates where the user places terminating characters or where they appear on a returning character string from the MPS.

Table 4-3. Sample BASIC Serial Interface Program

```

SEREXAM.BAS      EXAMPLE PROGRAM FOR SERIAL INTERFACE
This program works with QuickBasic 4.0/4.5 or Qbasic on an IBM PC or compatible
with a serial interface. It uses the COM1 communication port at 9600 BAUD. Enter
an instrument command or query at the prompt. The command transmits to the
instrument which displays any query response. Type "EXIT" to exit the program.
NOTE: The INPUT instruction in this example accepts no commas as part of an input
string. If a comma appears in an instrument command, replace it with a space.

CLS                                     'Clear screen
PRINT " SERIAL COMMUNICATION PROGRAM"
PRINT
TIMEOUT = 2000                          'Read timeout (may need more)
BAUD$ = "9600"

TERM$ = CHR$(13) + CHR$(10)             'Terminators are <CR><LF>

OPEN "COM1:" + BAUD$ + ",N,8,1,RS" FOR RANDOM AS #1 LEN = 256

LOOP1: INPUT "ENTER COMMAND (or EXIT):"; CMD$ 'Get command from keyboard
CMD$ = UCASE$(CMD$)                     'Change input to upper case
IF CMD$ = "EXIT" THEN CLOSE #1: END     'Get out on Exit
CMD$ = CMD$ + TERM$
PRINT #1, CMD$;                          'Send command to instrument

IF INSTR(CMD$, "?") <> 0 THEN           'Test for query
RS$ = ""                                 'If query, read response
N = 0                                    'Clr return string and count

WHILE (N < TIMEOUT) AND (INSTR(RS$, TERM$) = 0) 'Wait for response
IN$ = INPUT$(LOC(1), #1)                 'Get one character at a time
IF IN$ = "" THEN N = N + 1 ELSE N = 0 'Add 1 to timeout if no chr
RS$ = RS$ + IN$                          'Add next chr to string
WEND                                       'Get chrs until terminators

IF RS$ <> "" THEN                         'See if return string is empty
RS$ = MID$(RS$, 1, (INSTR(RS$, TERM$) - 1)) 'Strip off terminators
PRINT "RESPONSE:"; RS$                   'Print response to query
ELSE
PRINT "NO RESPONSE"                      'No response to query
END IF
END IF                                     'Get next command
GOTO LOOP1

```

4.3 SUMMARY OF IEEE-488/SERIAL INTERFACE COMMANDS

Below is an alphabetical list of IEEE-488/Serial Interface commands consisting of Operational Commands (Paragraph 4.3.1), Interface Commands (Paragraph 4.3.2), Ramping Commands (Paragraph 4.3.3), Current Zero Commands (Paragraph 4.3.4), Current Step Limit Commands (Paragraph 4.3.5), Computed Field Commands (Paragraph 4.3.6), and Common Commands (Paragraph 4.3.7).

OPERATIONAL COMMANDS

<i>Cmd</i>	<i>Function</i>
ERR?	Error Status Summary
IMAX	Upper Current Limit
IMAX?	Upper Current Limit Query
IOUT?	Output Current Query
ISET	Output Current Setting
ISET?	Output Current Setting Query
IV?	Output Summary Query
OVP?	Overvoltage Protection Query
RES?	Resolution
RI?	Remote Inhibit Status Query
VOUT?	Output Voltage Query
VSET	Compliance Voltage Setting
VSET?	Compliance Voltage Setting Query

INTERFACE COMMANDS

<i>Cmd</i>	<i>Function</i>
END	EOI Status
END?	EOI Status Query
MODE	Interface Status Mode
MODE?	Interface Status Mode Query
TERM	Terminator
TERM?	Terminator Query

RAMPING COMMANDS

<i>Cmd</i>	<i>Function</i>
RAMP	Ramp Segment Parameters
RAMP?	Ramp Segment Parameters Query
RMP	Ramp Status
RMP?	Ramp Status Query
SEG	Active Ramp Segment
SEG?	Active Ramp Segment Query

CURRENT ZERO COMMANDS

<i>Cmd</i>	<i>Function</i>
IMODE?	Current Programming Mode Query
VMODE?	Voltage Programming Mode Query
ZI	Zero Current Value Status
ZI?	Zero Current Value Query
ZIS	Zero Current Status
ZIS?	Zero Current Status Query

CURRENT STEP LIMIT COMMANDS

<i>Cmd</i>	<i>Function</i>
ISTP	Output Current Step Limit
ISTP?	Output Current Step Limit Query
ISTPS	Output Current Step Limit Status
ISTPS?	Output I Step Limit Status Query
STEP?	Output I Step Limit Exceeded Query
STEPR1	Output I Step Limit Exceeded Reset

COMPUTED FIELD COMMANDS

<i>Cmd</i>	<i>Function</i>
CFPA	Program Computed Field/Amp Constant
CFPA?	Computed Field/Amp Constant Query
CFUNI	Program Computed Field Display Units
CFUNI?	Computed Field Display Units Query
CFPS	Set Computed Field Display Status
CFPS?	Computed Field Status Query

COMMON COMMANDS

<i>Cmd</i>	<i>Function</i>
*CLS	Interface Clear
*ESE	Std. Event Status Enable Reg
*ESE?	Std. Event Status Query
*ESR?	Std. Event Status Enable Query
*IDN?	Identification Query
*OPC	Operation Complete
*OPC?	Operation Complete Query
*RST	Reset Command
*SRE	Service Request
*SRE?	Service Request Query
*STB?	Status Byte Query
*TST?	Self Test Query
*WAI	Wait-To-Continue

See Chapter 6 for additional IEEE-488 commands for the following MPS Options:

Model 6226/6476 LHe Level and Gaussmeter Input Card	Paragraph 6.2
Model 6228 Persistent Switch Heater Output	Paragraph 6.3

COMMAND (Shortcut Command): Short command description.

Input: Syntax of user input.

Returned: Informational response to query.

Remarks: Explanation and definition of informational response.

4.3.1 Operational Commands Description

Below is a list of MPS Operational Commands which configure the various functions.

ERR? Error Status Query

Input: ERR?

Returned: [OVP] [RI] [STEP]

Remarks: Returns 0 if the error is inactive or 1 if it is active. Returns three characters plus up to two terminators.

IMAX Programs Upper Current Limit

Input: IMAX [current] where [current] = a value between 0 and +50 A (620), 0 and +125 A (622), 0 and +155 A (623), or 0 and +72 A (647).

Remarks: Programs the upper (soft) current limit of the MPS. Truncates the value to the 0.001 place. The initial condition is +000.0000 A. The current limit is always forced to a plus. Setting is limited by product limits. Control Bus inputs 4 places, display rounds to 0.01 or 0.001 place.

IMAX? Current Limit Query

Input: IMAX?

Returned: A number between 0 and +50 A (620), 0 and +125 A (622), 0 and +155 A (623), or 0 and +72 A (647).

Remarks: Nine characters plus up to two terminators are returned. Value is shown as a "+," but applies to both positive and negative entries.

IOUT? (I?) Output Current Query

Input: IOUT? or I?

Returned: A number between 0 and ±50 A (620), 0 and ±125 A (622), 0 and ±155 A (623), or 0 and ±72 A (647).

Remarks: Returns nine characters plus up to two terminators.

ISET (I) Enter Output Current

Input: ISET [current] or I [current] where [current] = a value between 0 and ±50 A (620), 0 and ±125 A (622), 0 and ±155 A (623), or 0 and ±72 A (647).

Remarks: Value is truncated to the 0.001 place. Initial condition is +000.0000 A. Setting is limited by IMAX. Control Bus inputs 4 places, display rounds to 0.01 or 0.001 place.

ISET? Output Current Setting Query

Input: ISET?

Returned: A number between 0 and ±50 A (620), 0 and ±125 A (622), 0 and ±155 A (623), or 0 and ±72 A (647).

Remarks: Returns nine characters plus up to two terminators.

IV? Output Summary Query

Input: IV?

Returned: [IOUT], [VOUT], [STB], [I MODE], [V MODE]

Remarks: Returns twenty-seven characters plus up to two terminators.

OVP? Overvoltage (Quench) Protection Circuit Status Query

Input: **OVP?**

Returned: **0** if the circuit is inactive, or **1** if it is active.

Remarks: One character plus up to two terminators are returned.

RES? Resolution Query

Input: **RES?**

Returned: **0** for low resolution or **1** for high resolution. (This command maintains compatibility with older MPS versions. Remote interface operation does not change since the remote resolution is already to the 0.0001 place.)

Remarks: Returns two characters plus up to two terminators.

RI? Remote Inhibit Status Query

Input: **RI?**

Returned: **0** if the remote inhibit is inactive, or **1** if it is active.

Remarks: One character plus up to two terminators are returned.

VOUT? (V?) Output Voltage Query

Input: **VOUT?** or **V?**

Returned: A number between **0** and **±5.000 V** (620), **0** and **±30.000 V** (622/623), or **0** and **±32.000 V** (647).

Remarks: Returns nine characters plus up to two terminators.

VSET (V) Enter Compliance Voltage

Input: **VSET [voltage]** or **V [voltage]** where **[voltage]:** = a value from **0** and **±5.000 V** (620), **0** and **±30.000 V** (622/623), or **0** and **±32.000 V** (647).

Remarks: The initial condition is +00.0000 V. The voltage setting is always forced to a "+." Control Bus inputs 4 places, display rounds to 0.01 or 0.001 place.

VSET? Compliance Voltage Setting Query

Input: **VSET?**

Returned: A number between **0** and **±5.000 V** (620), **0** and **±30.000 V** (622/623), or **0** and **±32.000 V** (647).

Remarks: Returns nine characters plus up to two terminators.

4.3.2 Interface Commands Description

The MPS Interface Commands below help configure IEEE-488 interface compatibility for a variety of computer equipment.

END Programs MPS Interface EOI (End Or Identify) Status

Input: **END [status]** where **[status] = 0** to enable the EOI, or **1** to disable it.

Remarks: When enabled, the hardware EOI line becomes active with the last byte of a transfer. Not supported by Control Bus.

END? End Of Identify (EOI) Query

Input: END?

Returned: **0** if EOI is enabled, or **1** if it is disabled.

Remarks: Returns 1 character plus up to 2 terminators. Not supported by Control Bus.

MODE Programs MPS Interface Mode Status

Input: **MODE [status]** where **[status] = 0** for local mode, **1** for remote mode, or **2** for remote mode with local lockout. Supported in Control Bus operation.

MODE? Interface Mode Status Query

Input: MODE?

Returned: **0** for local mode, **1** for remote mode, or **2** for remote mode with local lockout.

Remarks: Returns 1 character plus up to 2 terminators. Supported by Control Bus.

TERM Programs MPS Interface Terminating Characters

Input: **TERM [type]** where **[type] =**
0 for a carriage return and line feed (CR)(LF^{EOI}),
1 for a line feed and carriage return (LF)(CR^{EOI}),
2 for a line feed (LF^{EOI}),
3 for no terminating characters (DAB^{EOI}) DAB = Last Data Byte

Remarks: Terminating characters are sent when the MPS completes its message on output. They also identify the end of an input message. Control Bus fixes terminators at (CR)(LF) on receipt and transmission.

TERM? Terminator Query

Input: TERM?

Returned: **0** for a carriage return and line feed (CR)(LF^{EOI})
1 for a line feed and carriage return (LF)(CR^{EOI})
2 for a line feed (LF^{EOI})
3 for no terminating characters (DAB^{EOI}) DAB = Last Data Byte

Remarks: Control Bus fixes terminators at (CR)(LF) on receipt and transmission.

4.3.3 Ramping Commands Description

The following MPS Ramping Commands configure the various functions of the ramping features.

RAMP Programs Ramp Segment Parameters

Input: **RAMP[segment],[initial ramp current],[final ramp current],[ramp rate],[00],[--:--:--:--]**
 where: **[segment]** = 1. (Future updates will allow up to nine segments.)
[initial ramp current] = 0 and ± 50 A (620), 0 and ± 125 A (622), 0 and ± 155 A (623),
 or 0 and ± 72 A (647).
[final ramp current] = 0 and ± 50 A (620), 0 and ± 125 A (622), 0 and ± 155 A (623), or
 0 and ± 72 A (647).
[ramp rate] = 0 to 99.9999 A/S.
[00]: Reserved for future use (Operation to perform). Need not be present for
 proper command operation.
[--:--:--:--]: Reserved for future use (DWELL time in days, hours, minutes and
 seconds). Does not need to be present for proper command operation.

Remarks: Truncates value to 0.001 place. Enter values with no embedded spaces. Undefined
 parameters are set to 0. Control Bus inputs 4 places, display rounds to 0.01 or 0.001 place.

Example: **RAMP1,+125.0000,-125.0000,01.0000[term]**

Indicates: Ramp Segment = 1;
 Initial Ramp Current = +125.0000 A;
 Final Ramp Current = -125.0000 A;
 Ramp Rate = 01.0000 A/S; commas can be replaced by blanks.

RAMP? Ramp Parameter Query

Input: **RAMP?**

Returned: Values are the same format as described above for programming in the ramp segments.

Remarks: Returns 48 characters and up to two terminators.

RMP Programs Ramp Status

Input: **RMP [ramp status]** where **[ramp status]** = 0 to turn off (HOLD) the ramp definitely, or 1 to
 turn on the ramp segment or continue a ramp on hold.

RMP? Ramp Status Query

Input: **RMP?**

Returned: 0 for holding, or 1 for ramping.

Remarks: One character plus up to two terminators are returned.

SEG Programs Active Ramp Segment

Input: **SEG [segment]** where **[segment]** = 1. (Future updates will allow multiple ramp segments).

SEG? Active Ramp Segment Query

Input: **SEG?**

Returned: 1. (Future updates will allow multiple ramp segments).

Remarks: Returns one character plus up to two terminator.

4.3.4 Current Zero Commands Description

The following MPS commands configure the various functions of the current zero features.

IMODE? Current Programming Mode Query

Input: **IMODE?**

Returned: **0** if I MODE switch is set to EXT, or **1** if set to INT.

Remarks: Returns one character plus up to two terminators. When multiple MPS units are present, the current programming mode of MPS No. 1 is reported.

VMODE? Voltage Programming Mode Query

Input: **VMODE?**

Returned: **0** if the V MODE switch is set to EXT, or **1** if set to INT.

Remarks: Returns one character plus up to two terminators. When multiple MPS units are present, the voltage programming mode of MPS No. 1 is reported.

ZI Programs Current Zero Value

Input: **ZI [current zero]** where **[current zero]** = a value between ± 999.9999 .

Remarks: Enter this setting after enabling ZI Status. Control Bus inputs 4 places, display rounds to 0.01 or 0.001 place. If a ZI value is entered over the Control Bus, status automatically turns ON.

ZI? Current Zero Value Query

Input: **ZI?**

Returned: A number between ± 999.9999 .

Remarks: Returns nine characters plus up to two terminators.

ZIS Programs Current Zero Status

Input: **ZIS [status]** where **[status]** = **0** to turn OFF the current zero, or **1** to turn it ON.

Remarks: When the current zero is turned off, the current zero value resets to 0.

ZIS? Current Zero Status Query

Input: **ZIS?**

Returned: **0** if the current zero is OFF, or **1** if it is ON.

Remarks: Returns one character plus up to two terminators.

4.3.5 Current Step Limit Commands Description

The following MPS commands configure the various functions of the current step limit features.

ISTP Programs Output Current Step Limit

Input: **ISTP [step limit]** where **[step limit]** = a value between 0 and +999.9900.

Remarks: Truncates the value to the 0.001 place. The initial condition is +000.000 A. The step limit is forced to a plus. Control Bus inputs 4 places, display rounds to 0.01 or 0.001 place.

ISTP? Output Current Step Limit Query

Input: **ISTP?**

Returned: A number between 0 and +999.9900 A.

Remarks: Returns nine characters plus up to two terminators. Value is shown as a "+", but applies to both positive and negative step changes.

ISTPS Programs Output Current Step Limit Status

Input: **ISTPS [status]** where **[status]** = **0** to turn OFF output current step limit, or **1** to turn it ON.

Remarks: The initial condition is **0**.

ISTPS? Output Current Step Limit Status Query

Input: **ISTPS?**

Returned: **0** for OFF, or **1** for ON.

Remarks: Returns one character plus up to two terminators.

STEP? Output Current Step Limit Exceeded Query

Input: **STEP?**

Returned: **0** if the step limit has not been exceeded, or **1** if it has been exceeded.

Remarks: Returns one character plus up to two terminators.

STEPR1 Output Current Step Limit Status Reset

Input: **STEPR1**

Returned: Nothing

Remarks: When the output current step limit has been exceeded, this command must be issued before normal operation can be resumed.

4.3.6 Computed Field Commands Description

The MPS can also display Computed Field rather than current. This is useful with Superconducting magnets because there is a linear relationship between the current and actual field to a reasonable degree of accuracy. This feature is not to be confused with the field as measured with the Model 6226 Liquid Helium Level and Gaussmeter Input Card. The commands and queries below allow users to calculate the same Computed field in the host computer as is displayed on the MPS front panel.

CFPA Programs Computed Field/Ampere Constant

Input: **CFPA [field/ampere]** where **field/ampere** is kG/ampere or tesla/ampere dependent on the computed field units.

Remarks: Programs the kG/ampere or tesla/ampere constant used primarily in superconducting magnets. Limited to 9.999 kG/ampere (0.9999 tesla). Value is rounded to 0.001 kG/ampere or 0.0001 tesla/ampere. Be aware of MPS units via the **CFUNI?** query so as not to be in error by a factor of 10.

CFPA? Computed Field/Ampere Constant Query

Input: **CFPA?**

Returned: A number between 0 and 9.999 kG/ampere or 0.9999 tesla/ampere

Remarks: Query units with **CFUNI?** to verify correct units. Returns 5 character plus up to 2 terminators.

CFUNI Program Computed Field Display Units

Input: **CFUNI [Units]** where **Units = K** displays kG, **Units = T** displays tesla.

Remarks: Enable computed field status with **CFPS** to display computed field.

CFUNI? Computed Field Units Query

Input: **CFUNI?**

Returned: Returns **K** if units = kG, **T** if units = tesla.

Remarks: Returns 1 character plus up to 2 terminators.

CFPS Set Computed Field Display Status

Input: **CFPA [Status]** where **Status = 0** displays amperes, **Status = 1** displays Computed Field.

Remarks: The computed field = kG or tesla based on the **CFUNI** units.

CFPS? Computed Field Status Query

Input: **CFPA?**

Returned: **0** = amperes currently displayed, **1** = Computed Field currently displayed.

Remarks: Returns 1 character plus up to 2 terminators.

4.3.7 Common Commands Description

The MPS Common Commands below are input/output commands defined by the IEEE-488 standard and shared with other instruments complying with the standard. Common commands begin with “*”.

***CLS** Clear Status Register Command

Input: *CLS

Returned: Nothing.

Remarks: Clears the Status Register, but *not* the instrument. It clears the bits in the Status Byte Register and the Standard Event Status Register and terminates all pending operations. The instrument-related command is *RST.

***ESE** Enables Status Reports In The Standard Event Status Enable Register

Input: *ESE [bit weighting] where [bit weighting] = the sum of the bit weighting of each bit to be set. The value can be 000 to 255. See the discussion on registers and below.

Remarks: Each bit is assigned a bit weighting. See the format of the Standard Event Status Register (given below) to see bit weighting and register placement. Further explanation of each bit is discussed in the register section following the Common Command Table. See Paragraph 4.1.3.2 for a complete description of status bits.

7	6	5	4	3	2	1	0	Bit
128	64	32	16	8	4	2	1	Weighting
PON	not used	CME	EXE	DDE	QYE	not used	OPC	Bit Name

Example: To set a bit, send the command *ESE with the sum of the bit weighting for each bit desired. For example, to set bits 0, 3, 4, and 5, send the command *ESE57. 57 is the sum of the bit weighting for each bit:

Bit	Weighting
0	1
3	8
4	16
5	32
	<u>57</u>

***ESE?** Standard Event Status Enable Query

Input: *ESE?

Returned: An integer between 000 and 255.

Remarks: Reads the Standard Event Status Enable Register. The integer returned represents the bits set in the Standard Event Status Enable Register. It is a sum of the bit weighting of each bit set. Returns three digits plus up to two terminators.

***ESR?** Standard Event Status Register Query

Input: *ESE?

Returned: An integer between 000 and 255.

Remarks: Reads the Standard Event Status Register. The integer returned represents bits set in the Service Request Enable Register. It is a sum of the bit weighting of each bit set. This Query supplies various error conditions and whether the MPS has been powered off and on since the last query. Returns three digits plus up to two terminators.

***IDN?** Identification Query

Input: *IDN?

Returned: Manufacturer, Model Number, Model Serial Number, Firmware Date.

Remarks: Returns seventeen characters plus up to two terminators.

Example: LSCI,622,0,120193[term]

***OPC** Operation Complete Status

Input: *OPC

Returned: Nothing.

Remarks: Causes the MPS to set an update cycle counter to 2. Each time through an update cycle, parameters entered by device dependent commands update and the cycle count decrements. Two update cycles complete all pending device dependent commands. When this occurs, the MPS sets the operation complete bit in the Standard Event Status Register (not the IEEE-488.2 defined operation). Not supported by Control Bus.

***OPC?** Operation Complete Status Query

Input: *OPC?

Returned: 0 or 1, where 0 indicates incomplete, 1 indicates complete.

Remarks: Places 1 in the instrument output queue and sets the Operation Complete Bit in the Standard Event Status Register upon completion of all pending selected device operations. This must be sent as the last command in a command string. Returns one character plus up to two terminators. Not supported by Control Bus.

***RST** Instrument Reset Command

Input: *RST

Returned: Nothing.

Remarks: Restores MPS to power-up settings just like the DCL and SDC bus commands. The MPS reverts to the Normal Display Screen, forces ramp status to the Hold mode, and clears any latched error along with the Status Byte and the Standard Event Status Registers. Not supported by Control Bus.

***SRE** Enables Status Reports In The Service Request Enable Register

Input: *SRE [bit weighting] where [bit weighting] = the sum (000 to 255) of bit weighting of each bit to be set. See the discussion on registers and below.

Remarks: Each bit is assigned a bit weighting. See the format of the Status Byte Register (given below) to see weighting and register placement of bits. See the register section following the Common Command Table. See Paragraph 4.1.3.1 for a complete description of status bits.

7	6	5	4	3	2	1	0	Bit
128	64	32	16	8	4	2	1	Weighting
SDR	SRQ	ESB	OVP	ERR	RSC	LIM	ODR	Bit Name

Example: If a bit in the Service Request Enable Register is set (1), its function is enabled and reported in the Status Byte Register. For example, to enable bits 1, 2, 4 and 6, send the command *SRE86. 86 is the sum of the bit weighting for each bit:

<u>Bit</u>	<u>Weighting</u>
1	2
2	4
4	16
6	64
	86

***SRE?** Service Request Enable Query

Input: *SRE?

Returned: An integer from **000-255**.

Remarks: Reads the Service Request Enable Register. The integer returned represents the sum of the bit weighting of each bit set. Returns three digits plus up to two terminators.

***STB?** Status Byte Query

Input: *STB?

Returned: An integer from **000-255**.

Remarks: Reads the Status Byte Register. The integer returned represents the sum of the bit weighting of each bit set. Although this query acts like a serial poll, it does not reset the register to all zeros. Returns three digits plus up to two terminators.

***TST?** Self Test Query

Input: *TST?

Returned: **0** = No errors **3** = Reserved **6** = AC High **9** = OI Active
1 = Remote Inhibit Active **4** = STP Error **7** = Rail High
2 = OVP Active **5** = AC Low **8** = Overtemperature Error
A = Setpoint Entry STP **B** = Rate Entry STP **C** = OPP (Overpower Protection) Error

Remarks: Causes instrument to report any failures. Returns 1 character plus up to 2 terminators.

***WAI** Wait-to-Continue Command

Input: *WAI

Returned: Nothing.

Remarks: The command prevents the instrument from executing any further commands or queries until all previous ones have been serviced. This command is accepted but not supported (not the IEEE-488.2 defined operation). Not supported by the Control Bus.

CHAPTER 5

ERROR MESSAGES AND TROUBLESHOOTING

5.0 GENERAL

This chapter covers Software Error Messages (Paragraph 5.1), Factory Default Settings (Paragraph 5.2), Calibration Procedure (Paragraph 5.3), Performance Test (Paragraph 5.4), Rear Panel Connectors Definition (Paragraph 5.5), IEEE-488 Connector Definition (Paragraph 5.6), and Serial Interface Cable and Adapters (Paragraph 5.7).

5.1 SOFTWARE ERROR MESSAGES

The MPS constantly monitors its circuits for faults like low or high line voltage, line loss, or internal temperature and rail faults. Upon detection, the error and a brief description display. Below are error messages that may display during normal operation:

Error 01 – Unwriteable NOVRAM Error

```

ERROR 01:
AN UNWRITEABLE NOVRAM DATA LOCATION
EXISTS IN THE DISPLAY NOVRAM. THIS
ERROR IS NOT CORRECTABLE BY THE USER.
CONTACT LSCI FOR A REPLACEMENT NOVRAM.
    
```

Error 02 – NOVRAM Data Verification Error

```

ERROR 02:
A NOVRAM DATA VERIFICATION ERROR EXISTS
IN THE DISPLAY NOVRAM. INITIALIZE THE
NOVRAM BY PRESSING THE Esc KEY FOR
10 SECONDS. IF THE ERROR STILL EXISTS,
CONTACT LSCI FOR A REPLACEMENT NOVRAM.
    
```

Error 06 – Calibration Data NOVRAM Error

```

ERROR 06:
A CALIBRATION DATA NOVRAM ERROR EXISTS
IN THE MAINFRAME. MAINFRAME CALIBRATION
MUST BE PERFORMED. CONTACT LSCI.
    
```

Output Current Step Limit Exceeded

If the MPS detects an output current change that exceeds the step limit, it enters Step Limit Mode and forces MPS output to 0 amps and 1 volt. On the next display update cycle, the MPS closes the FLT contacts to indicate the fault, sounds an alarm about once per second, and displays:

```

I STEP LIMIT EXCEEDED:      OUTPUTS:      *
OUTPUT CURRENT CHANGED
MORE THAN THE I STEP
LIMIT IN ONE UPDATE.      +1.999A
THE OKUTPUT SETTINGS ARE   +0.001V
FORCED TO 0 AND 1 V.
PRESS ↵ TO CLEAR ERROR.   *STEP LIMIT ^ *
    
```

The MPS sounds the alarm and halts operation until the user presses a Data Entry up or down key to clear the fault. When the fault clears, the MPS opens the FLT contacts, silences the alarm, and displays the normal display.

Remote Inhibit (RI) Detected

The Remote Inhibit (RI) and Fault (FLT) indicators provide hardware fault indication and remote shutdown in addition to internal protection features. The FLT indicator is a set of normally closed contacts when the unit is OFF. When the unit is ON and no fault is present, the contacts are open. If the MPS detects a fault or an RI input assertion from an external contact closure, it enters Remote Inhibit Mode, forces output settings to 0 amps and 1 volt, and turns ON the front panel Fault annunciator. The MPS closes the FLT contacts to indicate a fault, sounds the alarm once per second, and displays:

```

REMOTE INHIBIT:           OUTPUTS:      *
THE OUTPUT CURRENT SET-   +1.999A
TING IS FORCED TO ZERO.
                           +0.001V
THE OUTPUT SETTINGS
CANNOT BE CHANGED UNTIL
RI IS RELEASED.          **REMOTE INH.**
    
```

The alarm stops sounding when RI is removed, but the MPS continues to display RI until the user enters new output settings, then turns them OFF. This latching action informs the user of RI activity.

When the MPS detects no RI input activity, it turns OFF the front panel Fault annunciator and internal alarm, and opens the FLT contacts. When the MPS software detects open FLT contacts (RI is inactive), it displays the Normal Display.

To insert a 2 to 3 second delay between RI activation and the initial fault operation, turn CAL AND ID switch 7 ON (up); the MPS polls for RI activity after the delay. If RI is still active, the fault operation continues; if not, it is ignored.

In multiple MPS configuration, if an external contact closure activates the MPS RI indicators, the MPS units enter Multiple MPS Remote Inhibit Mode. They activate their output over voltage protection (OVP) circuits and turn off their output circuits. If a charged load is present, the OVP circuits discharge it, the front panel Fault annunciators turn ON, and the alarm sounds about once per second. If a MPS detects a fault, it closes the FLT contacts to initiate Multiple MPS Remote Inhibit Mode.

No delay is allowed (CAL AND ID switch 7 OFF, down) and multiple MPS operation (CAL AND ID switch 4 ON, up) must be selected. After the load discharges, turn OFF all units to reset. The MPS displays the OVP error message:

```

OVERVOLTAGE PROTECTION:  OUTPUTS:  *
FAULT OR RI DETECTED.    +1.999A
OVP IS ENABLED AND      +0.001V
OUTPUTS ARE DESABLED
LOAD MUST BE DISCHARGED
AND ALL UNITS TURNED
OFF TO RESET.           **REMOTE INH.**
    
```

Overvoltage Protection (OVP) Circuit Activated

If the voltage across the MPS output terminals rises above ± 40 volts, the output over voltage protection (OVP) circuit activates. The MPS also may activate the OVP circuit in response to faults. Upon activation, the OVP circuit uses thyristors to crowbar the output voltage to between 1 and 1.3 volts until magnet current reaches zero. If this occurs, change the output current setting to zero.

If the MPS detects OVP activity on power up (output current greater than ± 1 A), it turns ON the front panel Fault annunciator, closes FLT contacts, and sounds the alarm twice per second. When the MPS detects the fault, it closes the FLT contacts to indicate a fault, sounds the alarm once per second, and displays:

```

OVERVOLTAGE PROTECTION:  OUTPUTS:  *
THE OUTPUT CURRENT SET-  +1.999A
TING IS FORCED TO ZERO.  +0.001V
OVP IS ACTIVE UNTIL THE
OUTPUT CURRENT FALLS
BELOW 1 A.               **OVER VOLTAGE**
    
```

When output current falls below 1 A, the MPS turns OFF the front panel Fault annunciator and alarm, and opens the FLT contacts. When the MPS detects no OVP activity, the Normal Display appears.

The MPS continues to display OVP and sounds the alarm until the user enters new output settings, then turns them OFF. This latching action informs the user of OVP activity. The MPS opens the FLT contacts upon detecting OVP inactivity.

Level Alarm Reached

A unique level probe zero reference feature allows the user to define the current liquid level reading as the "zero reference" and reads levels above or below that reference. If turned ON, the software level alarm notifies the user if the continuously variable liquid level reaches the set point. The MPS closes the FLT contacts to indicate the fault, sounds the alarm about once per second, and displays:

```

LIQUID HELIUM LEVEL:    OUTPUTS:  *
+ READING : <OFF>      +1.999A
UNITS      :in (E)
NEXT RDG  :00:16
PERIOD    :01:00
ALARM     :+ 14.5 <ON>
ZERO REF  :+ 0.0 <OFF>
CALIBRATE PROBE
    
```

The alarm sounds until the level alarm is turned OFF. When it is turned OFF (or disabled), the MPS opens the FLT contacts and silences the alarm.

Low AC (LO AC) Detected

If the AC line falls below 80% of the nominal line selected, the MPS enters AC Loss Mode. If this occurs on power up, the MPS turns off the front panel circuit breaker and displays:

```

LO AC INPUT             OUTPUTS:  *
LINE FAULT:            +1.999A
                        +0.001V
THE UNIT WILL BE TURNED
OFF TO AVOID DAMAGE.
VERIFY AC INPUT SETTING  **LOW AC LINE**
    
```

This indicates that the AC source does not match the line voltage listed on the rear panel.

Upon utility loss during normal operation of a single MPS with a charged load, the MPS disables utility input circuitry and uses the load as an energy source. It turns OFF the front panel Power annunciator and turns ON the front panel Fault annunciator. It closes the FLT contacts to indicate a fault and sounds the alarm about once per second. The MPS sets output voltage compliance to the level required to maintain operation and continuously monitors output current. If the utility recovers, the MPS enters Remote Inhibit Mode and forces output settings to 0 amps and 1 volt. If the utility does not recover, the MPS activates the output OVP circuit and turns OFF the front panel circuit breaker when the output current drops below 10 amps. Upon power down, the MPS enters AC Loss Mode.

NOTE: A utility loss while the MPS returns energy from a charged load to the utility presents no hazard to personnel working on the utility circuit. The MPS is not a UPS. It uses the utility voltage wave form to draw energy from the utility with a sinusoidal current and return energy to the utility with a sinusoidal current. If there is no utility reference signal, the MPS disables utility input circuitry and uses the load for energy.

If utility loss occurs during normal operation in a multiple MPS configuration, the MPS detecting the utility loss initiates Multiple MPS Remote Inhibit Mode by closing the FLT contacts and turning off the front panel circuit breaker. Then the remaining MPS units enter Multiple MPS Remote Inhibit Mode.

High AC (HI AC) Detected

Any time the AC line rises above 120% of the nominal line selected, the MPS turns off the front panel circuit breaker and enters AC Loss Mode. This halts excessive utility voltages to internal circuitry. If this occurs on power up, the MPS turns off the front panel circuit breaker and displays:

```

HI AC INPUT          OUTPUTS: *
LINE FAULT:         +1.999A
                    +0.001V
THE UNIT WILL BE TURNED
OFF TO AVOID DAMAGE.
VERIFY AC INPUT SETTING  ** HI AC LINE**
    
```

Overtemperature Detected

If the MPS detects internal over temperature or other internal fault, it activates the OVP circuit, turns off the front panel circuit breaker, and then turns itself off. OVP stays active until it completely discharges the load. If the heat sink temperature exceeds 95 °C (203 °F), the MPS displays:

```

INTERNAL             OUTPUTS: *
TEMP FAULT:         +1.999A
                    +0.001V
THE UNIT WILL BE TURNED
OFF TO AVOID DAMAGE.
INTERNAL TEMP TOO HI   ** TEMP FAULT**
    
```

Rail Fault Detected

Excessive DC rail voltage (unable to return power to the utility or some other internal fault), causes the MPS to display:

```

INTERNAL             OUTPUTS: *
RAIL FAULT:         +1.999A
                    +0.001V
THE UNIT WILL BE TURNED
OFF TO AVOID DAMAGE.
DC RAIL VOLTAGE TOO HI ** RAIL FAULT**
    
```

PSH Current Not The Same As Saved Value

When the PSH is turned ON, the MPS checks the present current setting against the current setting stored when the PSH was turned OFF. If the two do not match, the MPS sounds an alarm for about ½ second and displays:

```

CAUTION! SETTING NOT SAME AS SAVED VALUE
          HEATER CURRENT:      50 mA
LAST PERSISTENCE CURRENT : 10.000 A
PRESENT SUPPLY CURRENT   :  5.000 A
ENTER KEY TO CHANGE TO LAST PERSISTENCE
CURRENT, WAIT RUNUP DELAY, THEN TURN OFF.
⇨ KEY TO TURN OFF AT PRESENT CURRENT.
Esc KEY TO ABORT.
    
```

Press the Data Entry up or down arrow to turn the PSH ON. Press no key for approximately 30 seconds, or press Esc to keep the PSH OFF.

Output Inhibit

When the red Output Inhibit button is pressed, the MPS displays:

```

OUTPUT INHIBIT:          OUTPUTS: *
THE OUTPUT CURRENT SET-  +1.999A
TING IS FORCED TO ZERO.  +0.001V
THE OUTPUT SETTINGS
CANNOT BE CHANGED UNTIL
OI IS RELEASED.         **OUTPUT INH.**
    
```

I STEP Limit Exceeded

When the user attempts to change the current setting by more than the step limit setting, the MPS displays:

```

I STEP LIMIT EXCEEDED
BY THIS SETTING
OUTPUT CURRENT WOULD BE SET TO MORE THAN
I STEP LIMIT PERMITTED IN 1 UPDATE.
THE CURRENT SETTING WILL NOT BE CHANGED.
    
```

Caution – Persistence Is Off, Heater Is On

When the user attempts to start Automatic Mode with persistence Off, the MPS displays:

```

CAUTION
THE PERSISTENCE IS OFF.
THE SWITCH HEATER IS ON.
CANNOT BEGIN WITH HEATER ON.
HIT THE Esc KEY TO ABORT.
    
```

Caution – Same Magnet Start and End Current

To enter an automatic PSH cycle, the magnet start and end current must be different. If they are the same, the MPS displays:

```

CAUTION
THE MAGNET START CURRENT AND THE MAGNET
END CURRENT ARE THE SAME. PRESS THE Esc
KEY TO ABORT, THE ENTER KEY TO CONTINUE.
    
```

Maximum Power Output Exceeded

When users utilize external current programming and output power exceeds 1000 watts, the MPS displays:

```

MAXIMUM POWER OUTPUT    OUTPUTS: *
EXCEEDED:               +1.999A
THE OUTPUT POWER IS
GREATER THAN PERMITTED.  +0.001V
SEE MANUAL FOR LIMIT.
THE OUTPUT CURRENT IS
FORCED TO ZERO AMPERE.
PRESS ⇨ TO CLEAR ERROR.  **OVER POWER **
    
```

Front panel settings are software limited to prevent power over 1000 watts.

5.2 Factory Default Settings

Below is a list of factory-presets. To reinitialize the MPS to factory presets at any time, hold the Esc key for about 15 seconds.

NOTE: If the MPS is part of a superconducting magnet system, the system supplier may change some of the parameters below to optimize MPS operation to the superconducting magnet it works with.

Automatic Mode Screen – This screen is unavailable if PSH option is not installed

MGT START: 0.000A – Magnet Start
 MGT END: 0.000A – Magnet End
 MGT RATE: 1.000A/S – Magnet Rate
 PERS RATE: 1.000A/S – Persistence Rate
 LAST END: 0.000A – Ending current from last magnet charge
 PERSISTENCE: <ON> – Persistence Mode Status
 RUN: ⏏ – Ramp Start Toggle

Automatic Mode Delays Screen

RUN UP: 60 S – Run Up
 PSH OFF: 60 S – PSH Off
 RAMP END: 60 S – Ramp End
 PSH ON: 60 S – PSH On

Manual Mode Screen

CURRENT: +0.000A – Current Setting
 COMPLIANCE: +1.000V – Compliance Voltage Setting (Cannot be changed in this screen)
 RAMP RATE: +1.000A/S – Ramp Rate
 RAMP ENABLE: <OFF> – Ramp Enable Off
 PERSISTENCE: <ON> – Persistence Status (Not present if PSH option not installed)

Instrument Setup Screen

FLD ENABLE: <OFF> – Magnetic Field Enable Off
 B UNITS: kG – Magnetic B-Field Units
 kG/A: ± 0.100 – Field per Amperes
 IMAX SET: $\pm 50.000\text{A}$ (620), $\pm 125.000\text{A}$ (622), $\pm 155.000\text{A}$ (623), $\pm 72.000\text{A}$ (647) – Maximum Current
 COMPLIANCE: $\pm 5.000\text{V}$ (620), $\pm 30.000\text{V}$ (622/623), $\pm 32.000\text{V}$ (647), – Maximum Compliance Voltage
 (Retains Last Setting On Power Down)

Step Limit/Zero Screen

CURRENT STEP LIMIT:
 STATUS: <ON> – Output Current Step Limit Status
 I STEP: +10.000A – Output Current Step Limit
 ZERO:
 STATUS: <OFF> – Output Current Zero Status
 I ZERO: +0.000A – Output Current Zero Value
 I MODE: INTERNAL – Output Current Programming Mode (Display Only)

Interface Setup Screen (If Present)

IEEE ADD: 12 – IEEE 488 Address
 TRMS/EOI: (CR LF) EOI – Terminators (Carriage Return & Line Feed) and EOI On
 RS-232C: 1200,N,8,1 – Serial I/O Definition (9600 Baud, No Parity, 8 data bits, 1 stop bit)
 CB DEF: 9600,o,7,1 – Control Bus Definition (9600 Baud, Odd Parity, 7 data bits, 1 stop bit)
 CB ADD: 0 – Control Bus Address
 VW ANGLE: 5 – Viewing Angle (5 = Straight On)
 MF ID: 622 (1) – Mainframe ID Number

Liquid Helium Level Screens (If Present)

READING: 00.00 <OFF> – Level Reading and Status
 UNITS: in (E) – Level Probe Units – Inches (English)
 NEXT RDG: 00:00 – Next Reading (HH:MM)
 PERIOD: 01.00 – Period (HH:MM)
 ALARM: +0.0<OFF> – Level Alarm and Status
 ZERO REF: +0.0<OFF> – Level Zero Reference and Status

Field Screen (If Present)

FIELD PROBE SETTING:
 UNITS: kG – Field Units in Kilogauss
 CALIBRATE PROBE:
 mV/kG: +0.800 – Field Probe Sensitivity

Persistent Switch Heater (PSH) Screen (If Present)

HEATER: 50mA – PSH Current
 STATUS: <OFF> – PSH Status
 LAST END: 0.000A – Ending current from last magnet charge

5.3 CALIBRATION

NOTE: Calibration is only as accurate as the current monitor shunt. The factory uses a current monitor shunt rated at 0.02% accuracy. Shunt manufacturers typically stock accuracy values of 0.25% or better. To use a different value, adjust readings given in the procedure.

1. Equipment requirements for MPS calibration:
 - a. Current monitor shunt, 100 mV output at 100A (1 milliohm), 0.02% accurate.
 - b. Load resistor, 10V at 100A (0.1 ohm), 1 kW.
 - c. Digital Volt Meter (DVM) with a resolution of 100 nV, 6½ digits, 0.0035% accurate (HP 3457A or equivalent).
 - d. A computer with a RS-232C serial interface.
 - e. LSCI Model 2002 RJ-11 to DB-25 adapter or Model 2003 RJ-11 to DE-9 adapter, depending on the computer serial output connector.
2. Turn OFF and unplug the MPS before configuring it for calibration.
3. Configure the Control Bus Serial Interface for RS-232C Operation. See Paragraph C4.0. Connect output to a computer using a modular cable, or if equipped, use the IEEE 6224 card.
4. Connect current monitoring shunt and load resistor in series to +OUT and –OUT terminals.
5. Enable MPS calibration. Locate rear panel CAL AND ID switches and turn ON (up) switch 8. Verify that both MODE switches in the INTernal (up) position.
6. Plug the MPS in, turn it ON, and allow it to warm up for one hour.

NOTE: To terminate calibration at any time, send **CALDN**. Cycle MPS power to recover calibration constants present prior to calibration initiation.

Calibration determines a zero, positive span, and negative span digital calibration constant for both current and voltage. Enter calibration constants with extreme caution. If a constant is entered incorrectly, terminate calibration with **CALDN** and re-start the sequence.

7. When calibrating current, the MPS forces **ISET** to calibration current. When calibrating voltage, the MPS forces **VSET** to calibration voltage and **ISET** to **IMAX**. Set **IMAX** to equal or greater than calibration current. Input and note the IMAX value using **IMAX?**. For this calibration, send **IMAX+50** to set **IMAX** to 50. Turn OFF the output current step feature during calibration. Input and note the output current step status using **ISTPS?**. Send **ISTPS0** to turn OFF output current step limiting.
8. Connect the DVM reading voltage across the +OUT and –OUT terminals.
9. Send **VZER** to inform the MPS of output voltage calibration and force output voltage to 0V. Verify a DVM reading of 0V ±0.1V. Allow MPS output to settle for 2 minutes.
10. Read actual output voltage from DVM. Send the MPS the actual voltage using **CALZ+xxx.xxxx**. If actual voltage is +0.0123V, send **CALZ+0.0123**. The MPS determines the zero voltage calibration constant.
11. Send **VCAL5** to force output voltage to +5 volts. Verify that the DVM reads +5V ±10%. Allow MPS output to settle for 2 minutes.
12. Read actual output voltage from the DVM. Send the actual voltage using **CALPL+xxx.xxxx**. If actual voltage is +5.1234V, send **CALPL+5.1234**. The MPS determines the positive voltage calibration constant.
13. After the MPS determines the positive voltage calibration constant, it automatically sets output voltage to the same value with the opposite sign. Verify a DVM reading of -5V ±10%. Allow MPS output to settle for 2 minutes.
14. Read actual output voltage from the DVM. Send the actual voltage using **CALMN-xxx.xxxx**. If actual voltage is -4.8766V, send **CALMN-4.8766**. The MPS determines the negative voltage calibration constant.
15. The MPS stores the zero, positive, and negative voltage calibration constants, then sets the output voltage to 0. Verify a DVM reading of 0V ±0.1V before continuing the calibration.
16. Connect DVM across current monitoring resistor.

17. Send **IZER** to force output current to 0 amps. Verify a DVM reading of $0V \pm 0.01V$. Allow MPS output to settle for 2 minutes.
18. Convert DVM voltage reading to current. A reading of $+0.000345V$ equals $+0.345A$. Send actual current using **CALZ+xxx.xxxx**. If actual current is $+0.345$ amps, send **CALZ+0.3450**. The MPS determines the zero current calibration constant.
19. Send **ICAL50** to inform MPS of output current calibration and to force output current to $+50$ amps. Verify a DVM reading of $+0.05V \pm 10\%$. Allow MPS output to settle for 2 minutes.
20. Convert DVM voltage reading to current. A reading of $+0.512345V$ equals $+51.2345A$. Send actual current with **CALPL+xxx.xxxx**. If actual current is $+51.2345A$, send **CALPL+51.2345**. The MPS determines the positive current calibration constant.
21. After the MPS determines the positive current calibration constant, it automatically sets output current to the same value with the opposite sign. Verify that the DVM reads $-0.05V \pm 10\%$. Allow MPS output to settle for 2 minutes.
22. Convert voltage reading from DVM to current. A reading of $-0.0487655V$ equals $-48.7655A$. Send actual current with **CALMN-xxx.xxxx**. If actual current is $48.7655A$, send **CALMN-48.7655**. The MPS determines the negative current calibration constant.
23. The MPS stores the zero, positive, and negative current calibration constants then sets output current to 0. Verify a DVM reading of $0V \pm 0.00005V$ before continuing the calibration.
24. Use **IMAX** and **STPS** to restore **IMAX** and output current step to Step 7 values.
25. Turn off MPS and disconnect calibration loads.
26. Restore original Control Bus Serial Interface settings.
27. Disable MPS calibration. Turn OFF (down) CAL AND ID switch 8.

5.4 PERFORMANCE TEST

Performance tests verify proper MPS operation into a resistive load without testing all specified parameters. The tests include no troubleshooting information, but can provide information that may localize faults. If any tests fail, contact authorized service personnel.

WARNING: For service, return MPS to Lake Shore or a factory representative. Lake Shore Cryotronics, Inc. cannot be held liable for injury or death of personnel attempting unauthorized MPS repairs.

Test Equipment Required

1. Current monitor shunt, 100 mV output, rated at 150 A . Manufacturers typically stock this shunt value. If a different value is used, adjust readings given in the procedure.
2. Digital Volt Meter (DVM) capable of reading DC voltage from 100 mV with 0.1 mV accuracy to 35 V with 0.1 V resolution.

Performance Test Procedure

The test procedure includes both front panel and remote operation. Execute the performance tests in the order given. Note any non-compliance.

Test Setup

1. Connect input power to the MPS as outlined in Sections 2.5 through 2.5.3 of this manual.
2. Disconnect any leads from MPS output terminals.
3. Set Programming Mode Switches on the MPS rear panel(s) to the INT (up) position. Set the CAL and ID switch 7 OFF (down).
4. Turn ON MPS. Initially, the display clears and the alarm sounds for a short time. Within two seconds, the Normal Display appears.

Output Voltage Verification

5. From the MPS front panel, select the Instrument Setup (INSTR. SETUP) menu and change compliance voltage to 5 V. Press the Normal Display key to return to the Normal Display screen.
6. Set output current to +1 A. Use the DVM to read the voltage across the MPS unit(s) output terminals. The reading should be +5 V \pm 0.3 V.
7. Set output current to 1 A. The DVM should read 5 V \pm 0.3 V.
8. Turn OFF MPS.

Output Current Verification

9. Use AWG #4 wire to connect the current monitor shunt between the MPS +OUT and -OUT terminals. Connect DVM across the shunt monitoring terminals. Note DVM offset reading.
10. Turn ON MPS. Within two seconds, the Normal Display appears.
11. Select the Instrument Setup (INSTR. SETUP) menu and change compliance voltage to 2 Volts. Press the Normal Display key to return to the Normal Display screen.
12. Wait 1 minute for MPS output to settle. The DVM should read the same as recorded for Step 9 \pm 0.01 mV.
13. Set output current to +50 Amps The DVM should read about +33 mV. After about 1 minute, the DVM should read +33.333 mV \pm 0.117 mV (not including offset from Step 9).
14. **Models 622/623 ONLY:** Set output current to +100 Amps. The DVM should read about +66 mV. After about 1 minute, the DVM should read +66.666 mV \pm 0.233 mV (not including offset from Step 9).
15. Set output current to -50 Amps. The DVM should read about -33 mV. After about 1 minute, the DVM should read -33.333 mV \pm 0.117 mV (not including the offset from Step 9).
16. **Models 622/623 ONLY:** Set output current to -100 Amps. The DVM should read about -66 mV. After about 1 minute, the DVM should read -66.666 mV \pm 0.233 mV (not including the offset from Step 9).
17. Set output current to 0 A.

Fault/RI Operation Verification

18. Short the MPS RI input with a shorting jumper. MPS output current should drop to 0 A, and the alarm should sound about once per second. Verify the MPS displays the RI screen shown in Paragraph 3.7.1.
19. With the unit ON, disconnect AC power connector. The front panel circuit breaker should trip.
20. The performance verification is complete.

5.5 REAR PANEL CONNECTOR DETAIL

Figure 5-1 MPS Rear Panel Connectors

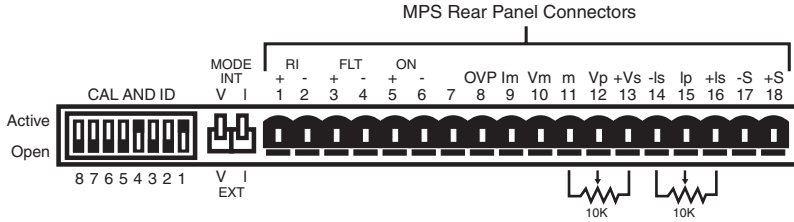

Table 5-1A Rear Panel Connector Definitions

TERMINAL	LABEL	DEFINITION
1 2	RI+ RI-	Remote Inhibit – Active low, TTL-compatible input to remotely disable the output (force the output settings to 0 A and 1 V).
3 4	FLT + FLT-	Fault Indicator – Normally open contact closure to indicate a fault condition has occurred. Contact rating: 0.25 A resistive at 100 VDC, 3 W, 25 VA.
5 6	ON+ ON-	ON Indicator – Contact closure to indicate when the front panel circuit breaker is in the ON position. Contact rating: 0.25 A resistive at 100 VDC, 3 W, 25 VA.
7	Reserved	None
8	OVP	Overvoltage Protection Enable – Analog signal connected in parallel to other MPS Units to remotely activate the output overvoltage protection circuit.
9	Im	Output Current Monitor – Voltage output from Im to GND(M) is ± 0.01 V/A.
10	Vm	Output voltage monitor – Voltage output from Vm to GND(M) is ± 0.01 V/V.
11	m	Monitor and program ground. GND(M).
12	Vp	Factory Use Only
13	+Vs	Factory Use Only
14	-Is	Enable external output current programming via MODE switch.
15	Ip	Voltage input from Ip to GND(M) is ± 0.01 V/A.
16	+Is	A 10 k Ω potentiometer from +Is to -Is with center tap to Ip produces the minimum voltage for full scale current output (± 1.25 V for Model 622 or ± 1.55 V for Model 623). Voltage applied to Ip sums with internal current programming voltage.
17 18	-S +S	Remote voltage sense correction. Correction for load lead drops of up to 0.5 V per lead.

Table 5-1B Rear Panel CAL AND ID Switch Definitions

Switch	Function
1 - 3	LSB Multi-Mainframe Address
4	Multi-Mainframe
5	Dither
6	Not Used
7	Inhibit Delay
8	Calibration

Figure 5-2 Serial Interface Connector

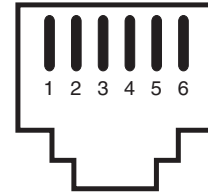

Table 5-2 Serial Interface Connector Definition

PIN	RS-232C FUNCTION	RS-485 FUNCTION
1	No Function	No Connection
2	Receive Data	A
3	Signal Ground	No Connection
4	Signal Ground	No Connection
5	Transmit Data	B
6	No Connection	No Connection

5.6 IEEE-488 INTERFACE CONNECTOR (WHEN MODEL 6224 OPTION IS PRESENT)

Connect to rear MPS IEEE-488 Interface connector with cables specified in the IEEE-488-1978 standard document. The cable has 24 conductors with an outer shield. The connectors at each end are 24-way Amphenol 57 Series (or equivalent) with piggyback receptacles to daisy-chain multiple devices. Secure connectors in the receptacles by a pair of captive locking screws with metric threads.

The total length of cable allowed in a system is 2 meters for each device on the bus, or 20 meters total for a maximum of 15 devices. The figure below and the table to the right shows the IEEE-488 Interface connector pin location and signal names.

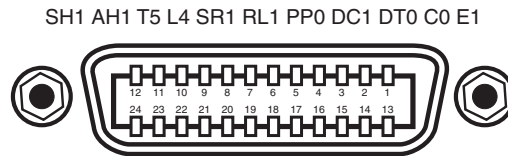

PIN	SYMBOL	DESCRIPTION
1	DIO1	Data Input/Output Line 1
2	DIO2	Data Input/Output Line 2
3	DIO3	Data Input/Output Line 3
4	DIO4	Data Input/Output Line 4
5	EOI	End Or Identify
6	DAV	Data Valid
7	NRFD	Not Ready For Data
8	NDAC	Not Data Accepted
9	IFC	Interface Clear
10	SRQ	Service Request
11	ATN	Attention
12	SHIELD	Cable Shield
13	DIO5	Data Input/Output Line 5
14	DIO6	Data Input/Output Line 6
15	DIO7	Data Input/Output Line 7
16	DIO8	Data Input/Output Line 8
17	REN	Remote Enable
18	GND 6	Ground Wire – Twisted pair with DAV
19	GND 7	Ground Wire – Twisted pair with NRFD
20	GND 8	Ground Wire – Twisted pair with NDAC
21	GND 9	Ground Wire – Twisted pair with IFC
22	GND 10	Ground Wire – Twisted pair with SRQ
23	GND11	Ground Wire – Twisted pair with ATN
24	GND	Logic Ground

Figure 5-3. IEEE-488 Interface Connector

5.7 SERIAL INTERFACE CABLE AND ADAPTERS

To aid in Serial Interface troubleshooting, the figures below provide wiring information for the cable assembly and the two mating adapters.

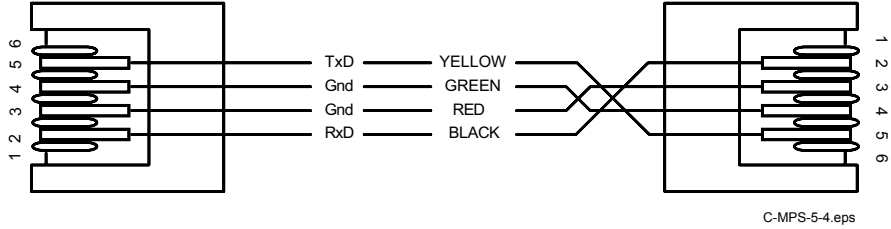

Figure 5-4. Model 2001 RJ-11 Cable Assembly Wiring

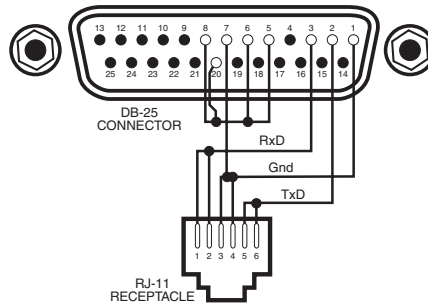

Figure 5-5. Model 2002 RJ-11 to DB-25 Adapter Wiring

● = Not Used

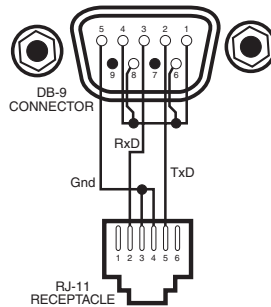

Figure 5-6. Model 2003 RJ-11 to DB-9 Adapter Wiring

CHAPTER 6

OPTIONS AND ACCESSORIES

6.0 GENERAL

This chapter covers MPS options and accessories: Model 6224 IEEE-488/Serial Interface installation (Paragraph 6.1), Model 6226/6476 Liquid Helium Level and Gaussmeter Input Card (Paragraph 6.2), Model 6228 Persistent Switch Heater Output (Paragraph 6.3), Model 6228-2 Persistent Switch Heater Output (Paragraph 6.4), and Accessories (Paragraph 6.5).

6.1 MODEL 6224 IEEE-488/SERIAL INTERFACE

This option interfaces with a Customer-supplied computer equipped with a compatible IEEE-488 or Serial Interface. It accesses operating data and stored parameters and remotely controls front panel operations. Only one Model 6224 is required for multiple MPS installations. See Chapter 4 for MPS remote operation.

Installation Procedure

WARNING

- **This procedure is intended for trained service personnel who understand electronic circuitry and the hazards involved. Do not attempt this procedure unless qualified.**
- **To prevent shock hazard, turn off the instrument and disconnect AC line power and all test equipment before proceeding.**

1. Turn unit OFF and disconnect power cord.
2. Remove the two screws of the blank option cover plate to the far left of the MPS rear panel and remove the cover plate. If another option exists in this slot, remove it. The IEEE cable should point down. Install the option in the far slot to avoid IEEE cable interference with the power cord.
3. Slide the Model 6224 board into the MPS with the board handle towards the bottom of the MPS. Tighten the two screws that secure the board to the MPS rear panel.
4. (If Required) Install the option removed from the Model 6224 slot into a different slot.
5. Set the IEEE-488 operating parameters as outlined in Paragraph 4.1.1 and the Serial Interface as outlined in Paragraph 4.2.2.

6.2 MODEL 6226/6476 LIQUID HELIUM LEVEL AND GAUSSMETER INPUT CARD

The Model 6226/6476 Liquid Helium Level and Gaussmeter Input Option combines liquid helium level and field monitoring in one input card. It monitors liquid level in percent, inches, or centimeters, and field in kilogauss or tesla. The field measurement is quantitative. Each input has independent excitation.

The level probe interfacing supports NbTi superconducting filaments and includes entry of probe length and determination of probe resistance over the length. A unique level probe zero reference feature allows the user to define the current liquid level reading as the "zero reference" and reads levels above or below that reference. A software level alarm notifies the user when the continuously variable liquid level set point has been reached.

When the liquid level measurement is not active, the field measurement is. The field interfacing supports Hall sensors and includes probe zero and entry of probe sensitivity in millivolts per kilogauss.

The Model 6226 and Model 6476 have the same level circuitry. The Model 6226 Gaussmeter is designed to operate with Hall sensors requiring 100 mA of excitation current. The Model 6476 Gaussmeter is designed to operate with high sensitivity Hall sensors requiring 1 mA or excitation current. Cards identified by a 1996 copyright containing 6XX6.S firmware are field-configurable to either model.

Below are specifications for the Model 6226/6476 Liquid Helium Level and Gaussmeter Input Card:

Liquid Helium Level:

Probe Type: NbTi Superconducting Filament	Sample Period: Fixed at 5 seconds
Number of Inputs: 1 four lead measurement	Maximum Resistance: 428 Ω
Nominal Excitation Current: 70 mA	Display Resolution: 1%, 0.1 inch, 0.1 cm
Compliance: 30 V	Electronic Accuracy: 1% of full scale
Input Voltage Resolution: > 1 mV out of 30 volts full scale	
Sample Interval: 1 min to 24 hours, continuous, or read on demand	

Model 6226 Gaussmeter:

Cryogenic Hall Sensor Type: Lake Shore Model HGCT-3020 (transverse) or Model HGCA-3020 (axial)	Display Resolution: 0.01 kG, 0.001 tesla
Number of Inputs: 1 four lead measurement	Electronic Accuracy: 1% of full scale
Nominal Excitation Current: 100 mA	
Probe Magnetic Sensitivity: 0.8 mV/kG \pm 30%	
Nominal Field Range: Nominal \pm 125 kG (@ 0.8 mV/kG)	
Input Voltage Resolution: > 0.01 mV out of 0.1 volts full scale	
Sample Interval: Probe excited continuously & read when level is not	

Model 6476 Gaussmeter:

Cryogenic Hall Sensor Type: Lake Shore Model MST-410 (transverse) or Model MSA-410 (axial)

Number of Inputs: 1 four lead measurement

Nominal Excitation: 1 mA

Probe Magnetic Sensitivity: 20 mV/mG \pm 50%

Nominal Field Range: Nominal \pm 20 kG (@ 20 mV/kG)

Input Voltage Resolution: > 0.04 mV out of 0.4 volts full scale

Sample Interval: Probe excited continuously & read when level is not

Display Resolution: 0.01 kG (0.001T)

Electronic Accuracy: 1% of full scale

Contact Lake Shore for details on a variety of Hall Probes and Sensors.

6.2.1 Hall Sensor Mounting Considerations - Models HGCT-3020 and HGCA-3020

The Lake Shore Model HGCT-3020 (Transverse) and Model HGCA-3020 (Axial) Cryogenic Hall Sensors are four terminal, solid state devices that produce output voltage proportional to the product of the input current, magnetic flux density, and the sine of the angle between the field vector and the plane of the Hall generator.

The active area of the Model HGCT-3020 Transverse Hall Sensor is approximately 0.04 inch in diameter with the center indicated by a cross on one face of the package. When the control current is applied with the red lead positive with respect to the black lead, and the magnetic field is perpendicular into the face of the probe with the cross on it, the Hall voltage is positive at the blue lead with respect to the yellow lead. A reversal in the mechanical orientation or in the direction of either the magnetic field or the control current results in a polarity change of the output voltage.

The active area of the Model HGCA-3020 Axial Hall Sensor is approximately 0.03 inch in diameter in the center of the face opposite the leads. When the control current is applied with the red lead positive with respect to the black lead, and the magnetic field is perpendicular into the face of the probe opposite the leads, the Hall voltage is positive at the blue lead with respect to the yellow lead. Again, a reversal in mechanical orientation or in the direction of either the magnetic field or control current results in a output voltage polarity change.

Handle the Hall sensor with care. The ceramic substrate is brittle and very sensitive to bending stress. Mount the sensor to minimize mechanical strains as the sensor cools. Failure rates approaching 10% occur on initial cool down with improperly installed sensors (sensors surviving initial cool down generally experience no problems on subsequent cycles). Avoid applying tension to the leads. Bend the leads at any angle so long as the bend is at least 0.125 inch away from the substrate connection. Mount the device to a non-flexible, smooth surface with a coefficient of thermal expansion no greater than a factor of three different from that of the ceramic substrate (about 7×10^{-6} in/in per K).

Locate the probe in a cavity that is 0.003 inch wider and 0.01 inch longer than the substrate, and with a depth the same or slightly greater than the thickness of the package. Tack the leads outside the slot with GE-7031 varnish or other similar substance. Sparingly apply the mounting substance to the corners or a dot on each side of the sensor to hold it in place. Avoid applying mounting substance on top of the sensor. Alternately, use Kapton[®] tape or a mechanical cover over the top of the sensor to keep it in place. The tape or cover should apply only light pressure to the sensor. If epoxy is the mounting substance, use it sparingly and use the same type as is used in the sensor, Stycast[®] 2850-FT epoxy. Never pot the probe.

A room temperature calibration over the range of ± 30 kG comes with each probe. The calibration specifies the terminating resistor (not included) required to maintain an accuracy of $\pm 1\%$ of reading up to ± 30 kG and $\pm 2\%$ of reading up to ± 150 kG over the entire temperature range. For a terminating resistor, use a metal film resistor with 1% or better accuracy mounted across the output voltage leads as close to the probe as is practical. To extend the leads, use AWG 34 stranded copper with Teflon insulation (the same wire used on the probe). Any impedance in the output leads acts as a voltage divider with the terminating resistor. Probe reading reproducibility is within $\pm 1\%$ over repeated thermal cycling between 4.2 K and room temperature.

6.2.2 The Model MSA-410 and MST-410 Hall Sensors

Models MSA-410 and MST-410 gaussmeter probes are used with the Model 6476. Lake Shore offers a ten-foot extension cable (Model MPEC-410-10).

6.2.3 Connections

The Model 6226/6476 has one rear panel 9-pin connector to interface with the level and field probes. See Table 6-1.

Table 6-1 Model 6226/6476 Connections

Terminal	Description
1	Field –Current
2	Field –Voltage
3	Field +Voltage
4	Field +Current
5	Shield
6	Level –Current
7	Level –Voltage
8	Level +Voltage
9	Level +Current

6.2.4 Installation

The 6226/6476 Liquid Helium Level and Gaussmeter Input Option is factory-installed if ordered with a MPS or may be field installed at a later date. For field installation, use the procedure below:

WARNING

- **This procedure is intended for trained service personnel who understand electronic circuitry and the hazards involved. Do not attempt this procedure unless qualified.**
- **To prevent shock hazard, turn off the instrument and disconnect AC line power and all test equipment before removing cover.**

1. Turn off the MPS and disconnect the power cord.
2. Locate the Optional Plug-In Board Slots on the MPS rear panel. Loosen the two screws that secure one of the blank cover plates and remove the cover plate.
3. Slide the Model 6226/6476 board into the MPS with the board handle towards the bottom of the MPS. Tighten the two screws that secure the board to the MPS rear panel.

6.2.5 LHe Level

Access liquid helium level and field monitoring from the MPS front panel. Press **Function Menu** and then **Next Menu** to display Function Menu 2. If the Model 6226/6476 Option is not present, **<NP>** appears next to LHe LEVEL and FIELD and associated function keys are ignored.

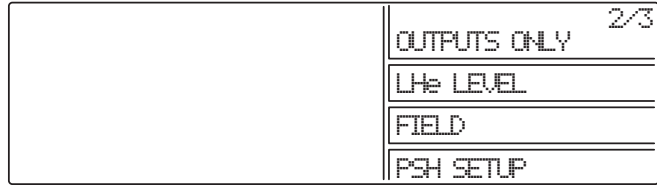

6.2.5.1 LHe Level Operation

Press the LHe LEVEL Function key to display the Liquid Helium Level screen. The Menu window returns to display Output values.

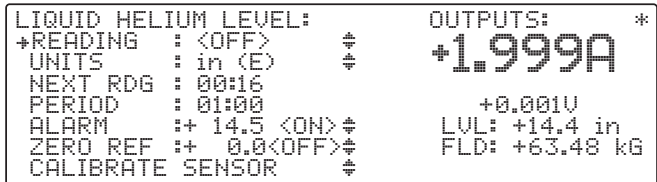

The cursor up and down keys move the line indicator. The $\#$ icon indicates parameters changed only with the Data Entry up and down arrows. When there are <ON> or <OFF> indicators, the Data Entry up and down arrows change the status if they are the first data entry keys used.

READING: <OFF> or <ON>

Level Reading Status. The Data Entry up or down arrow initiates a level reading.

UNITS: in. (E), %, or cm (M)

Level Units. The Data Entry up or down arrow scrolls through the available units: inches (English), % (percent), or centimeters (Metric).

NEXT RDG: 00:00 (Time in Hours:Minutes)

The Time to Next Reading.

PERIOD: 00:00 (Time in Hours:Minutes)

Level Sample Period. A time of 00:00 indicates a continuous reading (20 second period, 5 seconds for level reading). Use any numeric entry mode to change the value. Period limit is 23:59.

ALARM: + 0.0 (Reading) and <OFF> or <ON>

Level Alarm and Alarm Status. The Data Entry up or down arrow toggles the status. Use any numeric entry mode to change the value.

ZERO REF: + 0.0 (Reading) and <OFF> or <ON>

Level Zero Reference Value and Status. The Data Entry up or down arrow toggles the status. When ON, the value entered is the zero reference reading which the software subtracts from the actual level reading to give a "relative" level reading. Use any numeric entry mode to change the value.

CALIBRATE SENSOR

Change level sensor length, units, and calibration from this screen. The Data Entry up or down arrow displays the Level Calibration screen.

If the level alarm is on and the MPS detects that the level alarm has been reached, the MPS closes the FLT contacts to indicate the fault, sounds an alarm about once per second, and displays the screen to the right. The alarm continues to sound until the level alarm is turned off. When the alarm is turned off (or disabled), the MPS opens the FLT contacts and turns off the alarm.

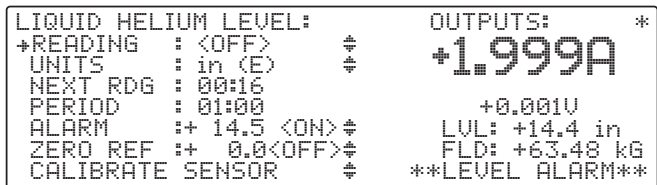

6.2.5.2 Field Probe Setting and Calibration

Press **Function Menu** and then **Next Menu** to display Function Menu 2. Press the **FIELD** Function key to display the Field screen to the right.

```

FIELD PROBE SETTING:      OUTPUTS: *
+UNITS      : kG      ⚡      +1.999A

CALIBRATE PROBE          +0.001V
mV/kG      : + 0.800    LVL: +14.4 in
ZERO RDG   : ⚡TO CALIBRATE  FLD: +0.501 kG
    
```

FIELD PROBE SETTING:

UNITS: T or kG

Field Units. The Data Entry up or down arrows scroll between the units: T (tesla) or kG (kilogauss). The default is kG.

CALIBRATE PROBE:

NOTE: The entries below change probe calibration. Do not change unless probe is actually being calibrated.

mV/kG: +XXX.XXX

Field Probe Sensitivity. Each Hall Probe comes with a mV/kG sensitivity. Use any numeric entry mode to change the value from 0 to 999.999.

ZERO RDG: <OFF> or <ON>

Field Probe Zero Reading. Connect the Hall Probe and place it in zero magnetic field. Press a Data Entry up or down arrow key to zero the probe.

6.2.6 Level Sensor Calibration

To enter or measure level sensor parameters, select **CALIBRATE SENSOR** (line 8) in the LIQUID HELIUM LEVEL screen. Prior to this, select a length of inches or centimeters (not percent). Units of length do not display on the calibration screen if percent is selected.

```

LEVEL SENSOR CONSTANTS:  OUTPUTS: *
+LENGTH      : 24.0 in    +0.000A
MIN Ω        : 0.00
Ω/inch      : 10.41
SELF CALIBRATION:        +0.000V
CALIBRATE MIN Ω      ⚡    LVL: +14.4 in
CALIBRATE Ω/inch    ⚡    FLD: +0.501 kG
    
```

LENGTH: 24.0 in or LENGTH: 61.0 cm

Level Sensor Length. Use any numeric entry mode to change the value. Allows values from 0.0 to 999.9.

MIN Ω: 0.00 (ohms)

Level Sensor minimum resistance in ohms. If minimum resistance is known, enter it directly with the Data Entry keys. Otherwise, measure it as shown below under **SELF CALIBRATION: CALIBRATE MIN Ω**.

Ω /inch: 10.41 or Ω /cm : 4.10

Level Sensor resistance per unit length. If the value is known, enter it directly with the Data Entry keys. Otherwise, it can be measured as shown below under **SELF CALIBRATION: CALIBRATE Ω/inch(cm)**.

CALIBRATE MIN Ω ⚡

Measures the Level Sensor minimum resistance. Connect the level sensor immersed in LHe to the active level sensor length. Move the cursor to **CALIBRATE MIN Ω** and press a Data Entry up/down arrow key. That line of the display changes to **CALIBRATING MIN Ω...** After measurement, the display updates the minimum resistance in line 3 and the display returns to that shown above.

CALIBRATE Ω/inch ⚡ or CALIBRATE Ω/cm ⚡

Measures the Level Sensor resistance per unit length. The resistance per unit length is a function of temperature. The effective value can be determined from the value measured at a more convenient temperature. Figure 6-1 and Table 6-2 show the resistance values as a function of temperature of a NbTi filament. The procedure described below measures the resistance per unit length at room temperature.

Take the level sensor out of the liquid and allow its temperature to stabilize. Move the cursor to **CALIBRATE Ω/inch** and press a Data Entry up/down arrow key. That line of the display changes to **CALIBRATING Ω/inch(cm)...** After measurement, the display updates the Ω/inch (Ω/cm) in line 4 and the display returns to that shown above.

NOTE: If the resistance is too large, the value is not updated. In that case, use a lower temperature or an ohmmeter to measure the resistance.

Look up the $R_{REF}/R(T)$ in Table 6-2 at the temperature of the sensor during measurement. Use the equation:

$$\left(\frac{\Omega}{L}\right)_{effective} = \frac{R(T)}{L_{active}} \times \left[\frac{R_{REF}}{R(T)} \right]$$

where L_{active} is the sensor length (line 2). Enter the computed value in line 4 manually.

Table 6-2. NbTi Filament Resistance Values

Temp. (K)	Temp. (°C)	Temp. (°F)	R ref/R (T)
305.15	32.00	89.60	0.8401
300.15	27.00	80.60	0.8424
299.15	26.00	78.80	0.8428
298.15	25.00	77.00	0.8433
297.15	24.00	75.20	0.8438
296.15	23.00	73.40	0.8442
295.15	22.00	71.60	0.8447
294.15	21.00	69.80	0.8452
293.15	20.00	68.00	0.8456
292.15	19.00	66.20	0.8461
291.15	18.00	64.40	0.8466
290.15	17.00	62.60	0.8470
273.15	0.00	32.00	0.8550
80.00	-193.15	-315.67	0.9613
77.35	-195.80	-320.44	0.9630
75.00	-198.15	-324.67	0.9646
22.00	-251.15	-420.07	0.9973
20.00	-253.15	-423.67	0.9981
15.00	-258.15	-432.67	1.0000
10.00	-263.15	-441.67	1.0046

Figure 6-1. NbTi Filament Resistance Chart

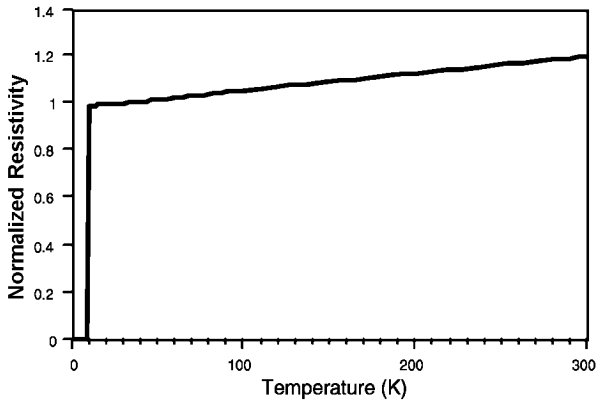

6.2.7 Model 6226/6476 IEEE-488 Remote Operation Commands

Cmd	Function	Cmd	Function	Cmd	Function
BFLD?	Magnetic Field Query	LALMS	Program Level Alarm Status	PER	Program Sample Period
BUNI	Program Field Units	LALMS?	Level Alarm Status Query	PER?	Sample Period Query
BUNI?	Field Units Query	LEVL	Read Level	ZREF	Program Probe Zero Reference
IBS?	Field Summary Query	LEVL?	Level Query	ZREF?	Probe Zero Reference Query
LALM	Program Level Alarm	LUNI	Program Level Units	ZREFS	Program Zero Reference Status
LALM?	Level Alarm Query	LUNI?	Level Units Query	ZREFS?	Zero Reference Status Query

BFLD? Magnetic Field Query
Input: **BFLD?**
Returned: A number between ±999.9999.
Remarks: Returns nine characters plus up to two terminators.

BUNI Program Magnetic Field Units
Input: **BUNI [units]** where **[units]** = **kG** for kilogauss, or **T** for tesla (10 kilogauss).
Remarks: The initial status is kG. Verify there is a space between the command and the units parameter.

BUNI? Magnetic Field Units Query
Input: **BUNI?**
Returned: Either **kG** for kilogauss or **T** for tesla (10 kilogauss).
Remarks: Returns two characters plus up to two terminators.

IBS? Magnetic Field Summary Query

Input: **IBS?**

Returned: **[IOUT], [BFLD], [STB]**

Remarks: Returns 23 characters plus up to two terminators.

LALM Program Level Alarm

Input: **LALM [alarm]** where **[alarm]** is the level value between 0 and ± 999.9 that activates the alarm. The value is truncated (not rounded) to the tenths place.

Remarks: The initial condition is 0. The alarm value uses the existing units. Conversion is made if units are changed.

LALM? Level Alarm Query

Input: **LALM?**

Returned: The value returned is a number between ± 999.9000 .

Remarks: Nine characters plus up to two terminators are returned.

LALMS Program Level Alarm Status

Input: **LALMS [status]** where **[status] = 0** for OFF, or **1** for ON.

Remarks: The initial condition is **0**.

LALMS? Level Alarm Status Query

Input: **LALMS?**

Returned: **0** or **1**. **0** indicates that the level alarm has not been reached. **1** indicates that the level is below the alarm value and the alarm has been activated.

Remarks: Returns one character plus up to two terminators.

LEVL Read LHe Level

Input: **LEVL [status]** where **[status] = 1** to read the level, or **0** not to read it.

Remarks: Reading the level requires a minimum of 5 seconds to update the level reading.

LEVL? LHe Level Query

Input: **LEVL?**

Returned: A number between ± 999.9000 .

Remarks: Returns nine digits plus up to two terminators.

LUNI Program LHe Level Units

Input: **LUNI [units]** where **[units] = "%"** for percentage, **"E"** for English units (inches), or **"M"** for metric units (centimeters).

Remarks: The initial condition is E (inches). Make sure there is a space between the command and the units parameter.

LUNI? LHe Level Units Query

Input: LUNI?

Returned: % for percentage, **E** for English units (inches), or **M** for metric units (centimeters)

Remarks: Returns one character plus up to two terminators are returned.

PER Program Sample Period

Input: PER [hours]:[minutes] where [hours] = 0 to 23, and [minutes] = 0 to 59.

Remarks: Programs the sample period in hours and minutes. The initial condition is 00:00, which defines a continuous sample period. Max. time is 23 hours, 59 seconds.

PER? Sample Period Query

Input: PER?

Returned: Hours and minutes programmed for the sample period, a comma, then the hours and minutes left in the sample period. **Example - 23:59,10:10[term]**. Indicates an initial sample period program of 23 hours and 59 minutes with 10 hours and 10 minutes remaining.

Remarks: Returns eleven characters plus up to two terminators.

ZREF Programs the probe zero reference

Input: ZREF [zero reference] where [zero reference] = a value between 0 and ±999.9 truncated (not rounded) to the tenths place.

Remarks: The initial condition is 0. The zero reference uses the existing units. Conversion is made if units are changed.

ZREF? Probe Zero Reference Query

Input: ZREF?

Returned: A number between ±999.9000.

Remarks: Returns nine characters plus up to two terminators.

ZREFS Program Probe Zero Reference Status

Input: ZREFS [status] where [status] = **1** to add the zero reference value to the level reading, or **0** to return the level reading to absolute.

Remarks: Programs the probe zero reference status. The initial condition is **0**. The level read above the zero reference is positive while the level read below the zero reference is negative.

ZREFS? Zero Reference Status Query

Input: ZREFS?

Returned: **0** if the probe zero reference status is disabled, or **1** if it is enabled.

Remarks: Returns one character plus up to two terminators.

6.3 MODEL 6228 AND 6228-8MUX PERSISTENT SWITCH HEATER OUTPUT

The Model 6228 Persistent Switch Heater (PSH) Output Option provides a variable 0-124 mA DC output in 4 mA increments. The output compliance is an 8 volt minimum and the load can be up to 100 ohms. An MPS front panel annunciator indicates PSH output current status. Model 6228 specifications are as follows:

Output Range: 0 to +124 mA

Load: 100 ohms maximum

Output Resolution: 4 mA

Off State Leakage Current: Less than 1 mA

Output Compliance: 8V minimum (8.7 typical at 124 mA)

The Model 6228 output current is present on a detachable terminal block with the I+ output on the terminal towards the top of the board (1) and the I- terminal towards the bottom of the board (2).

6.3.1 Installation

WARNING

- This procedure is intended for trained service personnel who understand electronic circuitry and the hazards involved. Do not attempt this procedure unless qualified.
- To prevent shock hazard, turn off the instrument and disconnect AC line power and all test equipment before removing cover.

NOTE: With multiple MPS units, install the Model 6228 in MPS1 for proper operation.

The 6228 is factory-installed if ordered with a MPS or can be field installed at a later date. For field installation, use the following procedure.

1. Turn off the MPS and disconnect the power cord.
2. Locate the Optional Plug-In Board Slots on the MPS rear panel. Remove the two screws that secure a blank cover plate to the MPS rear panel and remove the cover plate.
3. Slide the Model 6228 board into the MPS with the board handle towards the bottom of the MPS. Tighten the two screws that secure the board to the MPS rear panel.

```
CAUTION! SETTING NOT SAME AS SAVED VALUE
          HEATER CURRENT: 50 mA
LAST PERSISTENCE CURRENT : 10.000 A
PRESENT SUPPLY CURRENT   : 5.000 A
ENTER KEY TO CHANGE TO LAST PERSISTENCE
CURRENT; WAIT RUNUP DELAY; THEN TURN OFF.
⚡ KEY TO TURN OFF AT PRESENT CURRENT.
Esc KEY TO ABORT.
```

6.3.2 Model 6228 Operation

Access PSH Control from the MPS front panel. Press **Function Menu** then **Next Menu** to display Function Menu 2. If the 6228 PSH Option is not present, <NP> appears next to PSH SETUP and the associated function key is ignored.

	2/3
OUTPUTS ONLY	
LHe LEVEL	
FIELD	
PSH SETUP	

Press the PSH SETUP function key to enter the PSH Screen.

The cursor up and down keys move the line indicator (→). The ⚡ icon indicates parameters changed only with the Data Entry up and down arrows. Change all others using all the numeric entry modes, including the cursor.

HEATER: **XXX mA**

PSH Heater Current. Use any numeric entry mode to change the value from 0 to 999 mA.

```
PERSISTENCE HTR SETUP:        OUTPUTS:        *
+HEATER        : 50 mA                +2.000A
STATUS        : <HTR ON>                +0.000V
LAST END       : + 0.000A
```

STATUS: **<OFF> or <ON>**

PSH Status. Use the Data Entry up or down arrows to toggle the status.

LAST END: **+ 0.000 A**

Last Current Setting. This value is the current setting when the PSH was turned off. This value is retained in non-volatile memory so that the output current can be set to the magnet current when the PSH is turned on.

When PSH is ON, the MPS compares the present current setting with the current setting stored when PSH was OFF. If the two do not match, the MPS sounds the alarm for ½ second and displays:

```
CAUTION! SETTING NOT SAME AS SAVED VALUE
          HEATER CURRENT:      50 mA
LAST PERSISTENCE CURRENT : 10.000 A
PRESENT SUPPLY CURRENT   : 5.000 A
ENTER KEY TO CHANGE TO LAST PERSISTENCE
CURRENT; WAIT RUNUP DELAY; THEN TURN OFF.
↑ KEY TO TURN OFF AT PRESENT CURRENT.
Esc KEY TO ABORT.
```

Press a Data Entry up or down arrow to turn ON the PSH. If Esc is pressed, or no key is pressed for approximately 30 seconds, the PSH is not turned ON.

6.3.3 Model 6228-8MUX Operation

The 6226-8MUX is a persistence card with a multiplexed output. The output specifications are the same as the single 6228 option card. The heater supply current connects to one of eight persistence heaters. The PSH SETUP screen displays an additional line indicating the channel active if the heater is turned on. To change channels, access the PSH SETUP screen, move the cursor to the CHANNEL line, and use the Data Entry up and down arrows to increment to the desired channel. Select Channel 0 to force the heater off.

```
PERSISTENCE HTR SETUP:      OUTPUTS: *
+HEATER   : 50 mA          +2.000A
STATUS    : <HTR ON>
LAST END  : + 0.000A
CHANNEL   : 1              +0.000V
```

If the heater is on and connected to a channel, changing channels may cause problems. A warning displays to prevent a mishap.

```
PERSISTENCE HTR SETUP:      OUTPUTS: *
+HEATER   : 50 mA          +2.000A
STATUS    : <HTR ON>
LAST END  : + 0.000A
THE HEATER IS ON.
CANNOT CHANGE CHANNEL
WITH THE HEATER ON.
Esc TO CONTINUE.          +0.000V
```

The Normal Manual screen shows which channel connects to the heater when the heater turns on (persistence off). When a zero displays, the heater is off and not connected to any of the multiplexed outputs. When a 1 through 8 displays, then that multiplexed channel is controlled.

```
SETTINGS:                   OUTPUTS: *
+2.000A                     +2.000A
COMPLIANCE :+ 5.000V         +1.000V
RAMP RATE  :+ 1.000A/S
RAMP ENABLE: <OFF>
+CH 1,PERS.: <ON>
```

The magnet is put in and taken out of persistence via the last line on the Normal Manual Screen as with the 6228 PSH card. To change the channel number, access the Normal Manual Screen, use the Right/Left Cursor to move to the channel number, and then use the numerical keypad entry keys. The data Entry up or down arrow toggles the persistence on and off.

The Automatic Mode shown to the right allows channel selection on line 7 prior to running the Automatic change of persistence current.

```
AUTOMATIC MODE:            OUTPUTS: *
+MGT START : 10.000A       +0.000A
MGT END    : 15.000A
MGT RATE   : 1.000A/S
PERS RATE  : 1.000A/S
LAST END   : 10.000A
CH 1,PERS. : <ON>
RUN ↑              STANDBY
```

To change the channel number on the Automatic Screen, use the Right/Left Cursor to move to the channel number, and then use the numerical keypad entry keys. The Data Entry up or down arrow does not toggle persistence on and off. Persistence toggles on and off automatically.

6.3.4 PSH Card Voltage Constraints

The PSH (Persistence Switch Heater) card of the MPS supplies a current to a resistance heating element to "normal" a persistence wire opening the ends of a supercooled magnet to enable charge (current) change. Program current from 0 to 124 mA through the PSH Setup screen. Three conditions must be met when selecting an appropriate current:

1. The current must be enough to "normal" the switch element. The magnet manufacturer specifies this current and the heater resistance. This current must fall between the two following extremes.
2. The selected current multiplied by the heater resistance ($e = i \times r$) must be greater than 0.65 Vdc for the MPS to accurately determine switch status when heated. If less than 0.65 Vdc, the MPS may not properly report switch mode.

3. The selected current multiplied by the heater resistance ($e = i \times r$) must be less than 15 Vdc for the MPS to accurately determine compliance of the switch heater (open resistance).

Examples: A 100 ohm heater resistance set for 100 mA yields 10 volt compliance (Ohm's Law). This is greater than the required 0.75 Vdc and yet less than 15 Vdc. This allows proper performance. A 10 ohm heater resistance set for 50 mA yields 0.5 Vdc – less than the minimum for acceptable operation. The MPS cannot reliably determine the switch status and may report erroneously in some conditions. The best solution is to raise the current to 100 mA or greater while meeting all conditions.

6.3.5 Model 6228 Remote Operation Commands

IPSH Program PSH Current

Input: **IPSH [current]** where **[current]** = a value from 0 to 125 mA

Remarks: The initial condition is 0 mA. Current can be set from 0 to 125 mA but will actually be set in 4 mA increments.

IPSH? PSH Current Query

Input: **IPSH?**

Returned: A number between 0 and 125.

Remarks: Returns three characters plus up to two terminators.

PSH Program PSH Heater Status

Input: **PSH [status]** where **[status] = 0** to turn off the persistent switch heater, or **1** to turn on the persistent switch heater. Heater ON means persistence is OFF.

PSH? PSH Heater Status Query

Input: **PSH?**

Returned: **0** if the heater is OFF, or **1** if the heater is ON. If a current setting of 0 is entered, the value returned is 0. Heater ON means persistence is OFF.

Remarks: Returns one character plus up to two terminators.

PSHC? PSH Compliance Status Query

Input: **PSHC?**

Returned: **0** if PSH output is under the output compliance limit, or **1** if the output is over the limit.

Remarks: Returns one character plus up to two terminators.

PSHIS? Current Setting When PSH Was Turned Off

Input: **PSHIS?**

Returned: The value returned is a number between ± 125.0000 A.

Remarks: Returns nine characters plus up to two terminators.

PSHS? PSH Summary Query

Input: PSHS?

Returned: [PSH][PSH status][PSH compliance][current value][command status] where:
 [PSH] = 0 if PSH is present, or 1 if PSH is not present,
 [PSH heater status] = 0 if heater is OFF, or 1 if it is ON,
 [PSH compliance] = 0 if PSH is under compliance or 1 if it is over.
 [current value] = up to three characters which give the current value
 [command status] = 0 if the command status is OFF, or 1 if it is ON.

Remarks: Returns seven characters plus up to two terminators.

PSHCH Program PSH Channel (Multiplex PSH Card ONLY)

Input: PSHCH [channel], where [channel] = 0 to 8

Returned: Nothing.

Remarks: Command applies to the Model 6228-8MUX Card **ONLY**. 0 = heater OFF; 1 to 8 = heater ON.

PSHCH? PSH Channel Query (Multiplex PSH Card ONLY)

Input: PSHCH?

Returned: Channel number from 0 to 8

Remarks: Command applies to the Model 6228-8MUX Card **ONLY**. 0 = heater OFF; 1 to 8 = heater ON.
 Returns one character plus up to two terminators.

6.4 MODEL 6228-2 PERSISTENT SWITCH HEATER OUTPUT

The Model 6228-2 Persistent Switch Heater Output Option controls a second Persistent Switch. The output has the same specifications as the 6228 card.

The PSH SETUP screen using a 6228 and a 6228-2 card appears to the right. Only the heater currents can be changed on this screen. The status of the heater is either on or off. The last value is the current of the power supply when the heater was last turned off.

The PSH SETUP screen using a 6228-8MUX and a 6228-2 card appears to the right. Note that the Channel displays for the 6228-8MUX card. The heater currents and channel of the 6228-8MUX can be changed on this screen. The status of the heater is either on or off. The last value LAST 1 is the current of the power supply when the heater was last turned off for the given channel of the 6228-8MUX.

```

PERSISTENCE HTR SETUP:      OUTPUTS:      *
+HEATER 1 : 50 mA          +2.000A
STATUS 1  : <HTR ON>
LAST 1    : + 0.000A
CHANNEL   : 1              +0.000V
HEATER 2  : 50 mA
STATUS 2  : <HTR ON>
LAST 2    : + 0.000A
    
```

The PSH SETUP screen using ONLY a 6228-2 card appears to the right.

```

PERSISTENCE HTR2 SETUP:    OUTPUTS:      *
+HEATER 2 : 50 mA          +2.000A
STATUS 2  : <HTR ON>
LAST 2    : + 0.000A
                                +0.000V
    
```

6.4.1 Model 6228-2 Remote Operation Commands

IPSHB Program PSH Current
Input: **IPSHB [current]** where **[current]** = a value from 0 to 125 mA
Remarks: The initial condition is 0 mA. Current can be set from 0 to 125 mA but will actually be set in 4 mA increments.

IPSHB? PSH Current Query
Input: **IPSHB?**
Returned: A number between 0 and 125.
Remarks: Returns three characters plus up to two terminators.

PSHB Program PSH Heater Status
Input: **PSHB [status]** where **[status]** = **0** to turn OFF the persistent switch heater, or **1** to turn ON the persistent switch heater. Heater ON means persistence is OFF.

PSHB? PSH Heater Status Query
Input: **PSHB?**
Returned: **0** if the heater is OFF, or **1** if the heater is ON. If a current setting of 0 is entered, the value returned is 0. Heater ON means persistence is OFF.
Remarks: Returns one character plus up to two terminators.

PSHBC? PSH Compliance Status Query
Input: **PSHBC?**
Returned: **0** if PSH output is under the output compliance limit, or **1** if the output is over the limit.
Remarks: Returns one character plus up to two terminators.

PSHBIS? Current Setting When PSH Was Turned Off
Input: **PSHBIS?**
Returned: The value returned is a number between ± 125.0000 A.
Remarks: Returns nine characters plus up to two terminators.

PSHBS? PSH Summary Query
Input: **PSHBS?**
Returned: **[PSHB][PSHB status][PSHB compliance][current value][command status]** where:
[PSHB] = **0** if PSH is present, or **1** if PSH is not present,
[PSHB heater status] = **0** if heater is OFF, or **1** if it is ON,
[PSHB compliance] = **0** if PSH is under compliance or **1** if it is over.
[current value] = up to three characters which give the current value
[command status] = **0** if the command status is OFF, or **1** if it is ON.
Remarks: Returns seven characters plus up to two terminators.

6.5 ACCESSORIES

Accessories are devices that perform a secondary duty as an aid or refinement to the primary unit. Below are MPS accessories.

MODEL NUMBER	DESCRIPTION OF ACCESSORY
106-720	Terminal Block Mate, 18-Contact.
106-726	Detachable Power Connector.
106-730	Terminal Block Mate, 4 contact.
115-010	Detachable 240 VAC Line Cord (Great Britain).
115-011	Detachable 120 VAC Line Cord (USA, Canada).
115-012	Detachable 220 VAC Line Cord (Europe, SA).
2001	RJ-11 Cable Assembly. Four-Wire Cable Assembly with RJ-11 plugs on each end. Used with RS-232C Interface. Cable is 14 feet (4.6 meters) long. See Figure 5-4.
2002	RJ-11 to DB-25 Adapter. Adapts RJ-11 receptacle to female DB-25 connector. Used to connect Model 622/623 to Serial Port on rear of Customer's computer. See Figure 5-5.
2003	RJ-11 to DE-9 Adapter. Adapts RJ-11 receptacle to female DE-9 connector. Used to connect Model 622/623 to Serial Port on rear of Customer's computer. See Figure 5-6.
6007	Serial Optical Isolation Link.
8072	IEEE-488 Interface Cable. Cable is 3.4 feet (1 meter) in length.
MAN-623	Model 622/623 User's Manual.
MST-410	Transverse Probe. Used in electromagnetic fields. This probe is the same as used with the Lake Shore Model 410 Gaussmeter.
MSA-410	Axial Probe. Used in electromagnetic fields. This probe is the same as used with the Lake Shore Model 410 Gaussmeter.
MPEC-410-3	Extension Cable. Used with the Model MST-410 and MSA-410 listed above.
HGCT-3020	Hall Sensor, Magnetic Field, Cryogenic, Transverse. This is an individual transverse Hall sensor meant for use in cryogenic magnet applications. Refer to Paragraph 6.2.1. for mounting considerations.
HGCA-3020	Hall Sensor, Magnetic Field, Cryogenic, Axial. This is an individual axial Hall sensor meant for use in cryogenic magnet applications. Refer to Paragraph 6.2.1. for mounting considerations.
MCT-3160-WN	Probe, Magnetic Field, Cryogenic, Transverse. This is a complete 60 inch long Probe Assembly using a Model HGCT-3020 Transverse Hall Sensor.
MCA-2560-WN	Probe, Magnetic Field, Cryogenic, Axial. This is a complete 60 inch long Probe Assembly using a Model HGCA-3020 Axial Hall Sensor.
—	Output Cable Set. Output cables are 4 AWG. Each cable is 12 feet (3 meters) long.

APPENDIX A

UNITS FOR MAGNETIC PROPERTIES

Conversion from CGS to SI Units				
Quantity	Symbol	Gaussian & CGS emu ^a	Conversion Factor, C ^b	SI & Rationalized mks ^c
Magnetic flux density, Magnetic induction	B	gauss (G) ^d	10 ⁻⁴	tesla (T), Wb/m ²
Magnetic Flux	φ	maxwell (Mx), G•cm ²	10 ⁻⁸	weber (Wb), volt second (V•s)
Magnetic potential difference, magnetomotive force	U, F	gilbert (Gb)	10/4π	ampere (A)
Magnetic field strength, magnetizing force	H	oersted (Oe), ^e Gb/cm	10 ³ /4π	A/m ^f
(Volume) magnetization ^g	M	emu/cm ^{3h}	10 ³	A/m
(Volume) magnetization	4πM	G	10 ³ /4π	A/m
Magnetic polarization, intensity of magnetization	J, I	emu/cm ³	4π x 10 ⁻⁴	T, Wb/m ²ⁱ
(Mass) magnetization	σ, M	emu/g	$\frac{1}{4\pi \times 10^{-7}}$	$\frac{A \cdot m^2}{kg}$ Wb•m/kg
Magnetic moment	m	emu, erg/G	10 ⁻³	A•m ² , joule per tesla (J/T)
Magnetic dipole moment	j	emu, erg/G	4π x 10 ⁻¹⁰	Wb•m ⁱ
(Volume) susceptibility	χ, κ	dimensionless emu/cm ³	$(4\pi)^{-2} \times 10^{-7}$	Henry per meter (H/m), Wb/(A•m)
(Mass) susceptibility	χ _p , κ _p	cm ³ /g, emu/g	$\frac{4\pi \times 10^{-3}}{(4\pi)^2 \times 10^{-10}}$	$\frac{m^3}{kg}$ H•m ² /kg
(Molar) susceptibility	χ _{mol} , κ _{mol}	cm ³ /mol, emu/mol	$\frac{4\pi \times 10^{-6}}{(4\pi)^2 \times 10^{-13}}$	$\frac{m^3}{mol}$ H•m ² /mol
Permeability	μ	dimensionless	4π x 10 ⁻⁷	H/m, Wb/(A•m)
Relative permeability ^j	μ _r	not defined	-	dimensionless
(Volume) energy density, energy product ^k	W	erg/cm ³	10 ⁻¹	J/m ³
Demagnetization factor	D, N	dimensionless	1/4π	dimensionless

NOTES:

- a. Gaussian units and cgs emu are the same for magnetic properties. The defining relation is B = H + 4πM.
- b. Multiply a number in Gaussian units by C to convert it to SI (e.g. 1 G x 10⁻⁴T/G = 10⁻⁴T).
- c. SI (Système International d'Unités) has been adopted by the National Bureau of Standards. Where two conversion factors are given, the upper one is recognized under, or consistent with, SI and is based on the definition B = μ₀(H + M), where to μ₀ = 4π x 10⁻⁷H/m. The lower one is not recognized under SI and is based on the definition B = μ₀H + J, where the symbol I is often used in place of J.
- d. 1 gauss = 10⁹ gamma (γ).
- e. Both oersted and gauss are expressed as cm^{-3/2}•g^{1/2}•s⁻¹ in terms of base units.
- f. A/m was often expressed as "ampere-turn per meter" when used for magnetic field strength.
- g. Magnetic moment per unit volume.
- h. The designation "emu" is not a unit.
- i. Recognized under SI, even though based on the definition B = μ₀H + J. See footnote c.
- j. μ_r = μ/μ₀ = 1 + χ, all in SI. μ_r is equal to Gaussian μ.
- k. B • H and μ₀M • H have SI units J/m³, M • H and B • H/4π have Gaussian units erg/cm³.

R.B. Goldfarb and F.R. Fickett, U.S. Department of Commerce, National Bureau of Standards, Boulder, Colorado 80303, March 1985, NBS Special Publication 696. For sale by the Superintendent of Documents, U.S. Government Printing Office, Washington, D.C. 20402.

This Page Intentionally Left Blank

APPENDIX B

MAINFRAME CONTROL BUS OPERATION

B1.0 GENERAL

There are seven elements to the Model 622/623 Mainframe Control Bus operating instructions: Control Bus Serial Interface Specifications (Paragraph B2.0), Control Bus Serial Interface Connector (Paragraph B3.0), Control Bus Serial Interface Configuration (Paragraph B4.0), Selecting the Control Bus Serial Interface Address (Paragraph B5.0), Control Bus Serial Interface Operation (Paragraph B6.0), and a sample control bus serial interface program (Paragraph B7.0).

B2.0 CONTROL BUS SERIAL INTERFACE SPECIFICATIONS

The MPS Mainframe control bus serial interface may be configured either for RS-232C or RS-485. RS-232C is an unbalanced (single ended), non terminated line for short distances (typically less than 50 feet) where the host computer serial interface is dedicated to one MPS Mainframe. RS-485 is a balanced, terminated line for multidrop (party-line) configurations with up to 32 drivers and receivers sharing the same line for data transmission. Each interface instrument has a unique address and operates in a polled mode. Set the MPS Mainframe to respond to one of 32 addresses.

Serial Interface Specification	Configured For RS-232C	Configured For RS-485
Transmission	Three Wire	Two Wire
Address Configuration	None	Polled 1-32
Distance	50 Feet	4000 Feet
Connector	Dual RJ-11 Modular (phone) Jacks	
Timing Format	Asynchronous	
Transmission Rate	Half Duplex	
Baud Rate	9600	
Bits per Character	1 Start, 7 Data, 1 Parity, 1 Stop	
Parity Type	Odd	
Data Interface Levels	Tx/Rx Using EIA Levels	
Terminator	LF (0AH)	

B3.0 CONTROL BUS SERIAL INTERFACE CONNECTOR

The serial interface connectors use dual standard 6-wire RJ-11 modular (phone) jacks. The two connectors are in parallel and facilitate the RS-485 multidrop configuration. Lake Shore Model 2001 data cables, which maintain pin 1 polarity, simplify multiple Mainframe interconnection. Lake Shore offers the Model 2002 RJ-11 to DB-25 adapter and Model 2003 RJ-11 to DE-9 adapter to connect to the host computer.

Pin	RS-232C Function	RS-485 Function
1	No Connection	No Connection
2	Receive Data	A
3	Signal Ground	No Connection
4	Signal Ground	No Connection
5	Transmit Data	B
6	No Connection	No Connection

B4.0 CONTROL BUS SERIAL INTERFACE CONFIGURATION

Configure the control bus serial interface for either RS-232C or RS-485 communications with DIP switches on the Communications Processor Board (CMP). The CMP plugs into the Mainframe rear panel. The standard control bus serial interface configuration is RS-485. Use the procedure below to change or verify the serial interface configuration.

1. Turn off Mainframe and unplug the power cord.
2. Loosen the two screws that secure the CMP to the rear panel and slide the CMP out.
3. Locate and configure the control bus serial interface DIP switches as defined in the table to the right. The DIP switches are just inside the CMP front panel. Switches 1-4 define the interface as RS-232C. Switches 5-8 define the interface as RS-485 multidrop. Switch 8 activates 100Ω bus termination for long serial interface runs. For RS-485, terminate extremely long main lines at the furthest point from the host. Limit main line length to under 4000 feet and multiple short stub lines from the main line (Mainframe to Mainframe) to under 50 feet. A typical RS-485 configuration runs the main line from the host to one of the first Mainframe serial interface jacks; a Model 2001 cable plugs into the other first Mainframe serial interface jack to connect to the second Mainframe, and so on. Connect up to 32 Mainframes in this way. Terminate the last Mainframe only if it is a significant distance from the host. Assign unique addresses to multiple Mainframes on a RS-485 interface.
4. Replace the CMP.

CMP Configuration DIP Switch	RS-232C	Terminated RS-485	Unterminated RS-485
1	Closed	Open	Open
2	Closed	Open	Open
3	Closed	Open	Open
4	Closed	Open	Open
5	Open	Closed	Closed
6	Open	Closed	Closed
7	Open	Closed	Closed
8	Open	Closed	Open

B5.0 SELECTING THE CONTROL BUS SERIAL INTERFACE ADDRESS

Multiple Mainframes on the RS-485 interface each have a unique address and operate in a polled mode. Set the MPS Mainframe to respond to one of 32 addresses. Prefix all commands sent to a Mainframe with the Mainframe address. A Mainframe query response includes the address prefix if the address is not 0. The receipt of the LF (0AH) terminator resynchronizes communications and alerts all Mainframes that the next character is an address. A Mainframe with address 0 responds to all commands on the interface. A Mainframe using RS-232C can be given a unique address as well, but RS-232C is not suited for multi-drop operation. Access the Control Bus serial interface address from the Interface Setup screen. Press the Function Menu key to display Function Menu 1. Press the key corresponding to INTERFACE SETUP to display the Interface Setup screen.

Use the cursor key to move to the line indicating CB DEF and CB ADD; defined as follows.

CB DEF: 9600 Baud, No Parity, 8 Data Bits, and 1 Stop Bit

Control Bus Definition. The control bus should be defined as above.

CB ADD: 0 to 32

Control Bus Address. Use the Data Entry up or down arrows to increment or decrement the Control Bus Address. The initial condition is 0.

INTERFACE SETUP:	OUTPUTS: *
+ IEEE ADD : 12	+1.999A
TRMS/EOI : (CR LF) EOI	
RS232C : 9600,N,8,1	
CB DEF : 9600,0,7,1	+0.001V
CB ADD : 0	
UW ANGLE : 9	
MF ID : 622 (1)	

B6.0 CONTROL BUS SERIAL INTERFACE OPERATION

The host computer initiates the serial interface link and transmits either a command or a query to the Mainframe. The Mainframe stores the characters in a buffer until the carriage return (CR), line feed (LF) terminator sequence. After receiving the terminators, the Mainframe responds appropriately to a query, if present, and stores the new input parameters.

Queries output requested data immediately following the processing of the command and terminator sequence. If more than one query is sent, the last query received is acknowledged. Commands and queries can be sent in the same command string. For example, the command string **ISET+10 VSET+10** updates the current setting to +10 amps and the voltage setting to +10 volts. No query was sent, therefore the Mainframe returns no response. The command string **ISET+10 VSET+10 ISET?** causes the Mainframe to return the current setting as well.

The serial interface shares device specific commands with the IEEE-488 interface. Tables B-1 and B-2 summarize the commands. See Chapter 3 of this manual for detailed command descriptions. The END and TERM remote commands are IEEE-488 interface specific commands not supported by the serial interface.

When programming a Mainframe from the serial interface, consider the notes below. See Chapter 3 for additional notes on commands.

- The control bus serial interface transmission mode (asynchronous half duplex), format (10 bits per character; 1 start, 7 data, 1 odd parity, and 1 stop), and baud rate (9600) are all fixed at the factory as outlined previously in the Serial Interface Specifications.
- The control bus cannot be used for remote interfacing if a Multiple Mainframe (MMF) configuration is used. In MMF mode, the Control Bus is used for Mainframe to Mainframe communications.
- End of string terminators are fixed at (CR)(LF).
- A query must be added to the end of a command string if the Mainframe is required to return information.
- Chain commands together with a semi-colon, a comma, or a blank. Some programming languages do not allow separators other than a blank.
- At 9600 baud, each character takes about 1 millisecond to transmit. Some host computers DMA serial interface access. The program must allow for the transmission time delay before looking for a query response.
- Characters received by the Mainframe are stored in a buffer. After receiving the terminators, the Mainframe stores any new parameters and responds to the query (if requested). The Mainframe requires about 100 milliseconds to store new parameters before receiving any more new commands.
- The Mainframe implements new parameters and updates measurement data once per 500 millisecond operation cycle. Do not send new parameters or request data at a rate faster than 2 Hz.

B7.0 CONTROL BUS SERIAL INTERFACE SAMPLE PROGRAM

The following PC program is an interactive program that prompts the user for a Mainframe command and displays the Mainframe response. The command must include a query for the Mainframe to respond.

```
'This QuickBasic 4.0 program is for an IBM PC or compatible. Enter the
'Mainframe command at the prompt. The Mainframe response then displays.
'"END" exits the program.

COUNT = 1000
TERM$ = CHR$(13) + CHR(10)

OPEN "com1:9600,0,7,1,RS" FOR RANDOM AS #1 LEN = 256
L1: INPUT "ENTER COMMAND (END TO EXIT):", CMD$
CMD$ = UCASE$(CMD$)
IF CMD$ = "END" THEN CLOSE #1: END
PRINT #1, CMD$ + TERM$

IF INSTR(CMD$, "W") <> 0 OR INSTR(CMD$, "XD") <> 0 OR INSTR(CMD$, "?") <> 0 THEN
  RS$ = ""
  N = 0
  WHILE (N < COUNT) AND ((INSTR(RS$, TERM$) = 0) OR (RS$ = ""))
    R$ = INPUT$(LOC(1), #1)
    IF R$ = "" THEN N = N + 1 ELSE N = 0
    RS$ = RS$ + R$
  WEND
  IF RS$ <> "" THEN
    RS$ = MID$(RS$, 1, (INSTR(RS$, TERM$) - 1))
    PRINT "RESPONSE: "; RS$
  ELSE
    PRINT "NO RESPONSE"
  END IF
END IF
GOTO L1

END
```

Table B-1 MPS Mainframe Control Bus Remote Command Summary

Input Command	Query	Function
*CLS	–	Clear all pending status.
*ESE	*ESE?	Event status register enable.
–	*ESR?	Event status register contents.
–	*IDN?	Product identification.
*SRE	*SRE?	Service request (status byte) enable.
–	*STB?	Status byte register contents.
–	*TST?	Self-test error status.
MODE	MODE?	IEEE interface mode status (not used).
TERM	TERM?	IEEE interface terminator status. Terminators fixed at (CR)(LF).
I, ISET	I?, ISET?	Output current setting.
V, VSET	V?, VSET?	Output compliance voltage setting.
–	IOUT?	Output current measurement.
–	VOUT?	Output voltage measurement.
–	?	Output current, voltage, status byte, and programming mode.
IMAX	IMAX?	Maximum output current setting limit.
RAMP1	RAMP?	Ramp segment parameter programming.
SEG	SEG?	Active ramp segment (fixed at 1).
RMP	RMP?	Ramp active enable and status.
VCAL ICAL CALPL CALMN VZER IZER CALZ	–	Mainframe digital calibration.
ZI	ZI?	Output current zero setting.
ZIS	ZIS?	Output current zero enable and status.
–	IMODE?	Current programming mode switch status.
–	VMODE?	Voltage programming mode switch status.
–	RES?	Normal or high resolution status. (This command is obsolete. It is retained to maintain compatibility with older MPS units.)
–	OVP?	Output overvoltage protection status.
–	ERR?	Error Status.
–	RI?	Remote inhibit status.
ISTP	ISTP?	Output current step setting.
ISTPS	ISTPS?	Output current step enable and status.
STEPR1	–	Output current step status reset.

Table B-2 Additional MPS Mainframe Control Bus Remote Commands

Input Command	Query	Function
–	ADR	Mainframe address. Multidrop address 0-32 available. Commands sent must have the address as the first character. Query response will be “00” thru “32.”
LOC LOCK UNLOCK REM	CMD	Mainframe Programming Status. Query response will be the same as what is programmed. There is no real change in Mainframe status. MPS equivalent commands are: LOC UNLOCK MODE0 MODE0 LOCK REM MODE2 MODE1
–	ERRC	Mainframe Operational Status. Query response is status byte register contents, comma, standard event status register contents (equivalent to *STB? and *ESR? queries). Form of the response is XXX,XXX where XXX ranges from 000 to 255. *SRE and *ESE are forced to 255 to get a status response.
–	S1	Mainframe Error Status. Query response is equivalent to ERR?.
WA	RA	Output Current Setting. MPS equivalent commands are: WA ISET ISET? RA
PO	OP	Output Current Polarity Setting and Status.
–	AD1, AD8	Output Current Measurement. MPS equivalent command: IOUT?
–	AD2	Output Voltage Measurement. MPS equivalent command: VOUT?
–	AD3 – AD7	Internal Control Voltages. Query response forced to 000 until required responses are defined.
BAUD	–	Communications Baud Rate (Not Supported). Fixed at 9600.
N	–	Turn Mainframe Power ON (Not Supported).
F	–	Turn Mainframe Power OFF (Not Supported).
RS	–	Reset Mainframe Faults. (Only action taken is I Step Reset.)