



User's Manual

Model 331

Temperature Controller



Includes Coverage For:

Model 331S and Model 331E



Lake Shore Cryotronics, Inc.
575 McCorkle Blvd.
Westerville, Ohio 43082-8888 USA

E-mail addresses:

sales@lakeshore.com
service@lakeshore.com

Visit our website at:

www.lakeshore.com

Fax: (614) 891-1392

Telephone: (614) 891-2243

Methods and apparatus disclosed and described herein have been developed solely on company funds of Lake Shore Cryotronics, Inc. No government or other contractual support or relationship whatsoever has existed which in any way affects or mitigates proprietary rights of Lake Shore Cryotronics, Inc. in these developments. Methods and apparatus disclosed herein may be subject to U.S. Patents existing or applied for. Lake Shore Cryotronics, Inc. reserves the right to add, improve, modify, or withdraw functions, design modifications, or products at any time without notice. Lake Shore shall not be liable for errors contained herein or for incidental or consequential damages in connection with furnishing, performance, or use of this material.

LIMITED WARRANTY STATEMENT
WARRANTY PERIOD: ONE (1) YEAR

1. Lake Shore warrants that this Lake Shore product (the "Product") will be free from defects in materials and workmanship for the Warranty Period specified above (the "Warranty Period"). If Lake Shore receives notice of any such defects during the Warranty Period and the Product is shipped freight prepaid, Lake Shore will, at its option, either repair or replace the Product if it is so defective without charge to the owner for parts, service labor or associated customary return shipping cost. Any such replacement for the Product may be either new or equivalent in performance to new. Replacement or repaired parts will be warranted for only the unexpired portion of the original warranty or 90 days (whichever is greater).
2. Lake Shore warrants the Product only if it has been sold by an authorized Lake Shore employee, sales representative, dealer or original equipment manufacturer (OEM).
3. The Product may contain remanufactured parts equivalent to new in performance or may have been subject to incidental use.
4. The Warranty Period begins on the date of delivery of the Product or later on the date of installation of the Product if the Product is installed by Lake Shore, provided that if you schedule or delay the Lake Shore installation for more than 30 days after delivery the Warranty Period begins on the 31st day after delivery.
5. This limited warranty does not apply to defects in the Product resulting from (a) improper or inadequate maintenance, repair or calibration, (b) fuses, software and non-rechargeable batteries, (c) software, interfacing, parts or other supplies not furnished by Lake Shore, (d) unauthorized modification or misuse, (e) operation outside of the published specifications or (f) improper site preparation or maintenance.
6. TO THE EXTENT ALLOWED BY APPLICABLE LAW, THE ABOVE WARRANTIES ARE EXCLUSIVE AND NO OTHER WARRANTY OR CONDITION, WHETHER WRITTEN OR ORAL, IS EXPRESSED OR IMPLIED. LAKE SHORE SPECIFICALLY DISCLAIMS ANY IMPLIED WARRANTIES OR CONDITIONS OF MERCHANTABILITY, SATISFACTORY QUALITY AND/OR FITNESS FOR A PARTICULAR PURPOSE WITH RESPECT TO THE PRODUCT. Some countries, states or provinces do not allow limitations on an implied warranty, so the above limitation or exclusion might not apply to you. This warranty gives you specific legal rights and you might also have other rights that vary from country to country, state to state or province to province.
7. TO THE EXTENT ALLOWED BY APPLICABLE LAW, THE REMEDIES IN THIS WARRANTY STATEMENT ARE YOUR SOLE AND EXCLUSIVE REMEDIES.
8. EXCEPT TO THE EXTENT PROHIBITED BY APPLICABLE LAW, IN NO EVENT WILL LAKE SHORE OR ANY OF ITS SUBSIDIARIES, AFFILIATES OR SUPPLIERS BE LIABLE FOR DIRECT, SPECIAL, INCIDENTAL, CONSEQUENTIAL OR OTHER DAMAGES (INCLUDING LOST PROFIT, LOST DATA OR DOWNTIME COSTS) ARISING OUT OF THE USE, INABILITY TO USE OR RESULT OF USE OF THE PRODUCT, WHETHER BASED IN WARRANTY, CONTRACT, TORT OR OTHER LEGAL THEORY, AND WHETHER OR NOT LAKE SHORE HAS BEEN ADVISED OF THE POSSIBILITY OF SUCH DAMAGES. Your use of the Product is entirely at your own risk. Some countries, states and provinces do not allow the exclusion of liability for incidental or consequential damages, so the above limitation may not apply to you.

LIMITED WARRANTY STATEMENT (Continued)

9. EXCEPT TO THE EXTENT ALLOWED BY APPLICABLE LAW, THE TERMS OF THIS LIMITED WARRANTY STATEMENT DO NOT EXCLUDE, RESTRICT OR MODIFY, AND ARE IN ADDITION TO, THE MANDATORY STATUTORY RIGHTS APPLICABLE TO THE SALE OF THE PRODUCT TO YOU.

CERTIFICATION

Lake Shore certifies that this product has been inspected and tested in accordance with its published specifications and that this product met its published specifications at the time of shipment. The accuracy and calibration of this product at the time of shipment are traceable to the United States National Institute of Standards and Technology (NIST); formerly known as the National Bureau of Standards (NBS).

FIRMWARE LIMITATIONS

Lake Shore has worked to ensure that the Model 331 firmware is as free of errors as possible, and that the results you obtain from the instrument are accurate and reliable. However, as with any computer-based software, the possibility of errors exists.

In any important research, as when using any laboratory equipment, results should be carefully examined and rechecked before final conclusions are drawn. Neither Lake Shore nor anyone else involved in the creation or production of this firmware can pay for loss of time, inconvenience, loss of use of the product, or property damage caused by this product or its failure to work, or any other incidental or consequential damages. Use of our product implies that you understand the Lake Shore license agreement and statement of limited warranty.

FIRMWARE LICENSE AGREEMENT

The firmware in this instrument is protected by United States copyright law and international treaty provisions. To maintain the warranty, the code contained in the firmware must not be modified. Any changes made to the code is at the user's risk. Lake Shore will assume no responsibility for damage or errors incurred as result of any changes made to the firmware.

Under the terms of this agreement you may only use the Model 331 firmware as physically installed in the instrument. Archival copies are strictly forbidden. You may not decompile, disassemble, or reverse engineer the firmware. If you suspect there are problems with the firmware, return the instrument to Lake Shore for repair under the terms of the Limited Warranty specified above. Any unauthorized duplication or use of the Model 331 firmware in whole or in part, in print, or in any other storage and retrieval system is forbidden.

TRADEMARK ACKNOWLEDGMENT

Many manufacturers and sellers claim designations used to distinguish their products as trademarks. Where those designations appear in this manual and Lake Shore was aware of a trademark claim, they appear with initial capital letters and the ™ or ® symbol.

CalCurve™, Cernox™, Duo-Twist™, Quad-Lead™, Quad-Twist™, Rox™, and SoftCal™ are trademarks of Lake Shore Cryotronics, Inc.

MS-DOS® and Windows/95/98/NT/2000® are trademarks of Microsoft Corp.

NI-488.2™ is a trademark of National Instruments.

PC, XT, AT, and PS-2 are trademarks of IBM.



DECLARATION OF CONFORMITY

We: **Lake Shore Cryotronics, Inc.**
575 McCorkle Blvd.
Westerville OH 43082-8888 USA

hereby declare that the equipment specified conforms to the following Directives and Standards:

Application of Council Directives: **73/23/EEC**
89/336/EEC

Standards to which Conformity is declared: **EN61010-1:2001**
Overvoltage II
Pollution Degree 2
EN61326 A2:2001
Class A
Annex B

Model Number: **331**

1-7-2004

Ed Maloof
Printed Name

Vice President of Engineering
Position

Electromagnetic Compatibility (EMC) for the Model 331 Temperature Controller

Electromagnetic Compatibility (EMC) of electronic equipment is a growing concern worldwide. Emissions of and immunity to electromagnetic interference is now part of the design and manufacture of most electronics. To qualify for the CE Mark, the Model 331 meets or exceeds the requirements of the European EMC Directive 89/336/EEC as a **CLASS A** product. A Class A product is allowed to radiate more RF than a Class B product and must include the following warning:

WARNING: This is a Class A product. In a domestic environment, this product may cause radio interference in which case the user may be required to take adequate measures.

The instrument was tested under normal operating conditions with sensor and interface cables attached. If the installation and operating instructions in the User's Manual are followed, there should be no degradation in EMC performance.

This instrument is not intended for use in close proximity to RF Transmitters such as two-way radios and cell phones. Exposure to RF interference greater than that found in a typical laboratory environment may disturb the sensitive measurement circuitry of the instrument.

Pay special attention to instrument cabling. Improperly installed cabling may defeat even the best EMC protection. For the best performance from any precision instrument, follow the grounding and shielding instructions in the User's Manual. In addition, the installer of the Model 331 should consider the following:

- Shield measurement and computer interface cables.
- Leave no unused or unterminated cables attached to the instrument.
- Make cable runs as short and direct as possible. Higher radiated emissions is possible with long cables.
- Do not tightly bundle cables that carry different types of signals.

TABLE OF CONTENTS

Chapter/Paragraph	Title	Page
1	INTRODUCTION	1-1
1.0	PRODUCT DESCRIPTION	1-1
1.1	SENSOR SELECTION	1-4
1.2	SPECIFICATIONS	1-6
1.3	SAFETY SUMMARY	1-9
1.4	SAFETY SYMBOLS	1-10
2	COOLING SYSTEM DESIGN.....	2-1
2.0	GENERAL	2-1
2.1	TEMPERATURE SENSOR SELECTION	2-1
2.1.1	Temperature Range	2-1
2.1.2	Sensor Sensitivity	2-1
2.1.3	Environmental Conditions	2-2
2.1.4	Measurement Accuracy	2-2
2.1.5	Sensor Package.....	2-2
2.2	CALIBRATED SENSORS	2-2
2.2.1	Traditional Calibration	2-2
2.2.2	SoftCal™	2-3
2.2.3	Standard Curves	2-3
2.2.4	CalCurve™	2-3
2.3	SENSOR INSTALLATION	2-5
2.3.1	Mounting Materials	2-5
2.3.2	Sensor Location	2-5
2.3.3	Thermal Conductivity	2-5
2.3.4	Contact Area	2-5
2.3.5	Contact Pressure	2-6
2.3.6	Lead Wire.....	2-6
2.3.7	Lead Soldering.....	2-7
2.3.8	Heat Sinking Leads.....	2-7
2.3.9	Thermal Radiation.....	2-7
2.4	HEATER SELECTION AND INSTALLATION.....	2-7
2.4.1	Heater Resistance and Power	2-7
2.4.2	Heater Location.....	2-8
2.4.3	Heater Types	2-8
2.4.4	Heater Wiring	2-8
2.5	CONSIDERATIONS FOR GOOD CONTROL	2-8
2.5.1	Thermal Conductivity	2-8
2.5.2	Thermal Lag.....	2-8
2.5.3	Two-Sensor Approach	2-9
2.5.4	Thermal Mass	2-9
2.5.5	System Nonlinearity	2-9
2.6	PID CONTROL	2-9
2.6.1	Proportional (P).....	2-10
2.6.2	Integral (I).....	2-10
2.6.3	Derivative (D).....	2-10
2.6.4	Manual Heater Power (MHP) Output	2-10
2.7	MANUAL TUNING	2-12
2.7.1	Setting Heater Range	2-12
2.7.2	Tuning Proportional.....	2-12
2.7.3	Tuning Integral	2-13
2.7.4	Tuning Derivative	2-13
2.8	AUTOTUNING.....	2-13
2.9	ZONE TUNING.....	2-14

TABLE OF CONTENTS (Continued)

<i>Chapter/Paragraph</i>	<i>Title</i>	<i>Page</i>
3	INSTALLATION	3-1
3.0	GENERAL	3-1
3.1	INSPECTION AND UNPACKING	3-1
3.2	REPACKAGING FOR SHIPMENT	3-1
3.3	REAR PANEL DEFINITION	3-2
3.4	LINE INPUT ASSEMBLY	3-3
3.4.1	Line Voltage	3-3
3.4.2	Line Fuse and Fuse Holder	3-3
3.4.3	Power Cord	3-3
3.4.4	Power Switch	3-4
3.5	DIODE/RESISTOR SENSOR INPUTS	3-4
3.5.1	Sensor Input Connector and Pinout	3-4
3.5.2	Sensor Lead Cable	3-5
3.5.3	Grounding and Shielding Sensor Leads	3-5
3.5.4	Sensor Polarity	3-5
3.5.5	Four-Lead Sensor Measurement	3-6
3.5.6	Two-Lead Sensor Measurement	3-6
3.5.7	Lowering Measurement Noise	3-6
3.6	THERMOCOUPLE SENSOR INPUTS	3-7
3.6.1	Sensor Input Terminals	3-7
3.6.2	Thermocouple Installation	3-7
3.6.3	Grounding and Shielding	3-7
3.7	HEATER OUTPUT SETUP	3-8
3.7.1	Loop 1 Output	3-8
3.7.2	Loop 1 Heater Output Connector	3-8
3.7.3	Loop 1 Heater Output Wiring	3-8
3.7.4	Loop 1 Heater Output Noise	3-9
3.7.5	Loop 2 Output	3-9
3.7.6	Loop 2 Output Resistance	3-9
3.7.7	Loop 2 Output Connector	3-9
3.7.8	Loop 2 Heater Protection	3-9
3.7.9	Boosting the Output Power	3-9
3.8	ANALOG OUTPUT	3-10
3.9	RELAYS	3-10
3.10	INITIAL SETUP AND SYSTEM CHECKOUT PROCEDURE	3-11
4	OPERATION	4-1
4.0	GENERAL	4-1
4.1	FRONT PANEL DESCRIPTION	4-1
4.1.1	Keypad Definitions	4-1
4.1.2	Annunciators	4-3
4.1.3	General Keypad Operation	4-3
4.1.4	Display Definition	4-4
4.2	TURNING POWER ON	4-4
4.3	DISPLAY FORMAT AND SOURCE (UNITS) SELECTION	4-5
4.4	INPUT SETUP	4-7
4.4.1	Diode Sensor Input Setup - 10 μ A Excitation Current	4-7
4.4.2	Diode Sensor Input Setup - 1 mA Excitation Current	4-8
4.4.3	Resistor Sensor Input Setup	4-9
4.4.3.1	Thermal EMF Compensation	4-9
4.4.4	Thermocouple Sensor Input Setup	4-10
4.4.4.1	Room-Temperature Compensation	4-10
4.4.4.2	Room-Temperature Calibration Procedure	4-11
4.5	CURVE SELECTION	4-12
4.5.1	Diode Sensor Curve Selection	4-13

TABLE OF CONTENTS (Continued)

Chapter/Paragraph	Title	Page
4.5.2	Resistor Sensor Curve Selection	4-13
4.5.3	Thermocouple Sensor Curve Selection	4-13
4.6	TEMPERATURE CONTROL	4-14
4.6.1	Control Loops	4-14
4.6.2	Control Modes	4-15
4.6.3	Tuning Modes	4-15
4.7	CONTROL SETUP	4-15
4.8	MANUAL TUNING	4-17
4.8.1	Manually Setting Proportional (P)	4-17
4.8.2	Manually Setting Integral (I)	4-17
4.8.3	Manually Setting Derivative (D)	4-18
4.8.4	Setting Manual Heater Power (MHP) Output	4-18
4.9	AUTOTUNE (CLOSED-LOOP PID CONTROL)	4-19
4.10	ZONE SETTINGS (CLOSED-LOOP CONTROL)	4-20
4.11	SETPOINT	4-23
4.12	RAMP	4-24
4.13	HEATER RANGE AND HEATER OFF	4-25
4.14	MATH	4-26
4.14.1	Max/Min	4-26
4.14.2	Linear	4-27
4.14.3	Filter	4-28
4.15	ALARMS AND RELAYS	4-29
4.15.1	Alarms	4-29
4.15.2	Relays	4-31
4.16	ANALOG OUTPUT	4-32
4.16.1	Analog Output In Input Mode	4-32
4.16.2	Analog Output In Manual Mode	4-34
4.16.3	Analog Output In Loop 2 Mode	4-35
4.17	LOCKING AND UNLOCKING THE KEYPAD	4-35
4.18	DISPLAY BRIGHTNESS	4-36
4.19	REMOTE/LOCAL	4-36
4.20	INTERFACE	4-36
4.21	DEFAULT VALUES	4-37
5	ADVANCED OPERATION	5-1
5.0	GENERAL	5-1
5.1	CURVE NUMBERS AND STORAGE	5-1
5.1.1	Curve Header Parameters	5-1
5.1.2	Curve Breakpoints	5-2
5.2	FRONT PANEL CURVE ENTRY OPERATIONS	5-2
5.2.1	Edit Curve	5-4
5.2.1.1	Thermocouple Curve Considerations	5-5
5.2.2	Erase Curve	5-6
5.2.3	Copy Curve	5-6
5.3	SOFTCAL™	5-7
5.3.1	SoftCal With Silicon Diode Sensors	5-7
5.3.2	SoftCal Accuracy With Silicon Diode Sensors	5-8
5.3.3	SoftCal With Platinum Sensors	5-9
5.3.4	SoftCal Accuracy With Platinum Sensors	5-9
5.3.5	SoftCal Calibration Curve Creation	5-10
6	COMPUTER INTERFACE OPERATION	6-1
6.0	GENERAL	6-1
6.1	IEEE-488 INTERFACE	6-1
6.1.1	IEEE-488 Interface Parameters	6-2
6.1.2	IEEE-488 Command Structure	6-2

TABLE OF CONTENTS (Continued)

<i>Chapter/Paragraph</i>	<i>Title</i>	<i>Page</i>
6.1.2.1	Bus Control Commands	6-2
6.1.2.2	Common Commands.....	6-3
6.1.2.3	Device Specific Commands.....	6-3
6.1.2.4	Message Strings.....	6-3
6.1.3	Status Registers.....	6-4
6.1.3.1	Status Byte Register and Service Request Enable Register	6-4
6.1.3.2	Standard Event Status Register and Standard Event Status Enable Register	6-4
6.1.4	IEEE Interface Example Programs.....	6-5
6.1.4.1	IEEE-488 Interface Board Installation for Visual Basic Program	6-5
6.1.4.2	Visual Basic IEEE-488 Interface Program Setup.....	6-7
6.1.4.3	IEEE-488 Interface Board Installation for Quick Basic Program	6-10
6.1.4.4	Quick Basic Program.....	6-10
6.1.4.5	Program Operation.....	6-13
6.1.5	Troubleshooting	6-13
6.2	SERIAL INTERFACE OVERVIEW	6-14
6.2.1	Physical Connection.....	6-14
6.2.2	Hardware Support.....	6-14
6.2.3	Character Format	6-15
6.2.4	Message Strings	6-15
6.2.5	Message Flow Control	6-16
6.2.6	Changing Baud Rate.....	6-16
6.2.7	Serial Interface Example Programs.....	6-17
6.2.7.1	Visual Basic Serial Interface Program Setup.....	6-17
6.2.7.2	Quick Basic Serial Interface Program Setup	6-20
6.2.7.3	Program Operation.....	6-21
6.2.8	Troubleshooting	6-21
6.3	COMMAND SUMMARY	6-22
6.3.1	Interface Commands (Alphabetical Listing).....	6-24
7	OPTIONS AND ACCESSORIES	7-1
7.0	GENERAL	7-1
7.1	MODELS	7-1
7.2	OPTIONS	7-1
7.3	ACCESSORIES.....	7-2
7.4	MODEL 3003 HEATER OUTPUT CONDITIONER.....	7-4
8	SERVICE	8-1
8.0	GENERAL	8-1
8.1	ELECTROSTATIC DISCHARGE.....	8-1
8.1.1	Identification of Electrostatic Discharge Sensitive Components.....	8-1
8.1.2	Handling Electrostatic Discharge Sensitive Components.....	8-1
8.2	LINE VOLTAGE SELECTION	8-2
8.3	FUSE REPLACEMENT	8-2
8.4	REAR PANEL CONNECTOR DEFINITIONS	8-3
8.4.1	Serial Interface Cable Wiring	8-5
8.4.2	IEEE-488 Interface Connector	8-6
8.5	TOP OF ENCLOSURE REMOVE AND REPLACE PROCEDURE.....	8-7
8.6	FIRMWARE AND NOVDRAM REPLACEMENT	8-7
8.7	JUMPERS	8-8
8.8	ERROR MESSAGES.....	8-8
8.9	CALIBRATION PROCEDURE	8-10
8.9.1	Equipment Required for Calibration	8-10
8.9.2	Diode/Resistor Sensor Input Calibration	8-11
8.9.2.1	Sensor Input Calibration Setup and Serial Communication Verification	8-11
8.9.2.2	10 μ A Current Source Calibration and 1 mA Current Source Verification.....	8-11

TABLE OF CONTENTS (Continued)

<i>Chapter/Paragraph</i>	<i>Title</i>	<i>Page</i>
8.9.2.3	Diode Input Ranges Calibration.....	8-12
8.9.2.4	Resistive Input Ranges Calibration	8-13
8.9.3	Diode Sensor Input Calibration - 1 mA Excitation Current	8-14
8.9.4	Thermocouple Sensor Input Calibration.....	8-14
8.9.4.1	Sensor Input Calibration Setup.....	8-14
8.9.4.2	Thermocouple Input Ranges Calibration	8-14
8.9.5	Analog Output Calibration (Model 331S Only)	8-15
8.9.5.1	Analog Output Calibration	8-16
8.9.6	Calibration Specific Interface Commands	8-17
APPENDIX A – GLOSSARY OF TERMINOLOGY.....		A-1
APPENDIX B – TEMPERATURE SCALES		B-1
APPENDIX C – HANDLING OF LIQUID HELIUM AND NITROGEN		C-1
APPENDIX D – CURVE TABLES		D-1

LIST OF ILLUSTRATIONS

<i>Figure No.</i>	<i>Title</i>	<i>Page</i>
1-1	Model 331S Rear Panel Connections	1-3
2-1	Silicon Diode Sensor Calibrations and CalCurve	2-4
2-2	Typical Sensor Installation In A Mechanical Refrigerator	2-6
2-3	Examples of PID Control.....	2-11
3-1	Model 331 Rear Panel.....	3-2
3-2	Line Input Assembly.....	3-3
3-3	Diode/Resistor Input Connector	3-4
3-4	Thermocouple Input Definition and Common Connector Polarities.....	3-7
3-5	RELAYS and ANALOG OUTPUT Terminal Block.....	3-10
4-1	Model 331 Front Panel	4-1
4-2	Display Definition	4-4
4-3	Display Format Definition	4-5
4-4	Record of Zone Settings.....	4-22
4-5	Deadband Example.....	4-29
4-6	Relay Settings	4-31
5-1	SoftCal Temperature Ranges for Silicon Diode Sensors.....	5-8
5-2	SoftCal Temperature Ranges for Platinum Sensors.....	5-9
6-1	GPIB Setting Configuration	6-6
6-2	DEV 12 Device Template Configuration.....	6-6
6-3	Typical National Instruments GPIB Configuration from IBCONF.EXE.....	6-11
7-1	Model 331 Sensor and Heater Cable Assembly.....	7-4
7-2	Model 3003 Heater Output Conditioner	7-4
7-3	Model RM-1/2 Rack-Mount Kit	7-5
7-4	Model RM-2 Dual Rack-Mount Kit.....	7-6
8-1	Power Fuse Access.....	8-2
8-2	Sensor INPUT A and B Connector Details	8-3
8-3	HEATER OUTPUT Connector Details.....	8-3
8-4	RELAYS and ANALOG OUTPUT Terminal Block.....	8-4
8-5	RS-232 Connector Details.....	8-4
8-6	IEEE-488 Rear Panel Connector Details.....	8-6
8-7	Location of Internal Components	8-9
B-1	Temperature Scale Comparison	B-1
C-1	Typical Cryogenic Storage Dewar.....	C-1

LIST OF TABLES

Table No.	Title	Page
1-1	Sensor Temperature Range	1-4
1-2	Typical Sensor Performance	1-5
1-3	Input Specifications	1-6
1-4	Sensor Input Configuration.....	1-6
1-5	Heater Output.....	1-7
1-6	Loop 1 Full Scale Heater Power at Typical Resistance	1-7
4-1	Sensor Input Types	4-7
4-2	Sensor Curves.....	4-12
4-3	Comparison of Control Loops 1 and 2.....	4-14
4-4	Linear Equation Configuration	4-27
4-5	Default Values	4-38
5-1	Curve Header Parameters.....	5-3
5-2	Recommended Curve Parameters	5-3
6-1	IEEE-488 Interface Program Control Properties.....	6-8
6-2	Visual Basic IEEE-488 Interface Program.....	6-9
6-3	Quick Basic IEEE-488 Interface Program.....	6-12
6-4	Serial Interface Specifications	6-15
6-5	Serial Interface Program Control Properties.....	6-18
6-6	Visual Basic Serial Interface Program	6-19
6-7	Quick Basic Serial Interface Program.....	6-20
6-8	Command Summary	6-23
8-1	Calibration Table for Diode Ranges	8-12
8-2	Calibration Table for Resistive Ranges	8-14
8-3	Calibration Table for Thermocouple Ranges.....	8-15
B-1	Temperature Conversion Table.....	B-2
C-1	Comparison of Liquid Helium and Liquid Nitrogen	C-1
D-1	DT-470 Silicon Diode Curve	D-1
D-2	DT-670 Silicon Diode Curve	D-2
D-3	DT-500 Series Silicon Diode Curves	D-2
D-4	PT-100/-1000 Platinum RTD Curves.....	D-3
D-5	RX-102A Rox™ Curve	D-4
D-6	RX-202A Rox™ Curve	D-5
D-7	Type K Thermocouple Curve.....	D-6
D-8	Type E Thermocouple Curve.....	D-7
D-9	Type T Thermocouple Curve.....	D-8
D-10	Chromel-AuFe 0.03% Thermocouple Curve.....	D-9
D-11	Chromel-AuFe 0.07% Thermocouple Curve.....	D-10

CHAPTER 1

INTRODUCTION

1.0 PRODUCT DESCRIPTION

The Model 331 Temperature Controller combines the easy operation and unsurpassed reliability of the Model 330 with improved sensor input and interface flexibility, including compatibility with negative temperature coefficient (NTC) resistance temperature detectors (RTDs). Backed by the Lake Shore tradition of excellence in cryogenic sensors and instrumentation, the Model 331 Temperature Controller sets the standard for mid-price range temperature control instruments.

The Model 331 Temperature Controller is available in two versions. The Model 331S is fully equipped for interface and control flexibility. The Model 331E shares measurement and display capability with the Model 331S, but does not include the IEEE-488 interface, relays, analog voltage output, or a second control loop.

Sensor Inputs

The Model 331 Temperature Controller is designed for high performance over a wide operating temperature range and in difficult sensing conditions. The Model 331 features two inputs, with a high-resolution 24-bit analog-to-digital converter and separate current source for each input. Sensors are optically isolated from other instrument functions for quiet and repeatable sensor measurements. Sensor data from each input can be read up to ten times per second, with display updates twice each second. The Model 331 uses current reversal to eliminate thermal EMF errors in resistance sensors.

Standard temperature response curves for silicon diodes, platinum RTDs, and many thermocouples are included. Up to twenty 200-point CalCurves™ for Lake Shore calibrated sensors or user curves can be loaded into non-volatile memory via a computer interface or the instrument front panel. A built-in SoftCal™¹ algorithm can also be used to generate curves for silicon diodes and platinum RTDs, for storage as user curves.

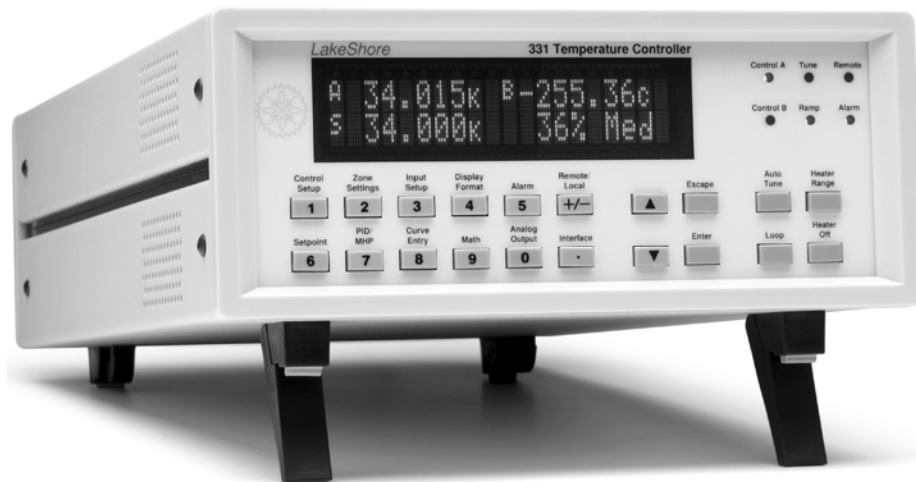

¹ The Lake Shore SoftCal™ algorithm for silicon diode and platinum RTD sensors is a good solution for applications requiring more accuracy than a standard sensor curve but not in need of traditional calibration. SoftCal uses the predictability of a standard curve to improve the accuracy of an individual sensor around a few known temperature reference points. Both versions of the Model 331 can generate SoftCal curves.

Product Description (Continued)

Sensor inputs for both versions of the Model 331 are factory configured and compatible with either diode/RTDs or thermocouple sensors. The purchaser's choice of two diode/RTD inputs, one diode/RTD input and one thermocouple input, or two thermocouple inputs must be specified at time of order and cannot be reconfigured in the field. Software selects appropriate excitation current and signal gain levels when sensor type is entered via the instrument front panel.

Temperature Control

The Model 331E offers one and the Model 331S offers two proportional-integral-derivative (PID) control loops. A PID control algorithm calculates control output based on temperature setpoint and feedback from the control sensor. Wide tuning parameters accommodate most cryogenic cooling systems and many small high-temperature ovens. Control output is generated by a high-resolution digital-to-analog converter for smooth continuous control. The user can set the PID values or the Autotuning feature of the Model 331 can automate the tuning process.

Heater output for Model 331S and Model 331E is a well-regulated variable DC current source. Heater output is optically isolated from other circuits to reduce interference and ground loops. Heater output can provide up to 50 W of continuous power to a resistive heater load, and includes two lower ranges for systems with less cooling power. Heater output is short-circuit protected to prevent instrument damage if the heater load is accidentally shorted.

The setpoint ramp feature allows smooth continuous changes in setpoint and can also make the approach to a setpoint temperature more predictable. The zone feature can automatically change control parameter values for operation over a large temperature range. Values for ten different temperature zones can be loaded into the instrument, which will select the next appropriate value on setpoint change.

Interface

The Model 331 is available with both parallel (IEEE-488, 331S only) and serial (RS-232C) computer interfaces. In addition to data gathering, nearly every function of the instrument can be controlled via computer interface. Also included is a Model 330 command emulation mode that makes the Model 331 interchangeable with the older Model 330 in software controlled systems.

Each input has a high and low alarm which offer latching and non-latching operation. The two relays on the Model 331S can be used in conjunction with the alarms to alert the operator of a fault condition or perform simple on-off control. Relays can be assigned independently to any alarm or be operated manually.

When not being used for temperature control, the loop 2 control output can be used as an analog voltage output. It can be configured to send a voltage proportional to temperature to a strip-chart recorder or data acquisition system. The user may select the scale and data sent to the output, including temperature, sensor units, or linear equation results. Under manual control, the analog voltage output can also serve as a voltage source for other applications.

Interface Features of Model 331S and Model 331E

<i>Feature</i>	<i>331S</i>	<i>331E</i>
Numeric keypad	■	■
Front panel curve entry	■	■
Alarms	■	■
RS-232C interface	■	■
IEEE-488 interface	■	
Second control loop	■	
Analog voltage output	■	
Two relays	■	

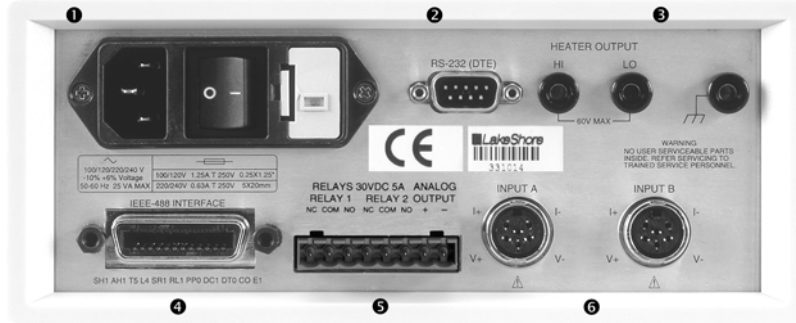

- ❶ Line input assembly
- ❷ Serial (RS-232C) I/O (DTE)
- ❸ Heater output
- ❹ IEEE-488 interface
- ❺ Terminal block (for relays and analog output)
- ❻ Sensor input connectors

Figure 1-1. Model 331S Rear Panel Connections

Configurable Display

Both versions of the Model 331 include a bright vacuum fluorescent display that simultaneously displays up to four readings. Display data includes input and source annunciators for each reading. All four display locations can be configured by the user. Data from either input may be assigned to any of the four locations; the user's choice of temperature, sensor units, maximum, minimum, or linear equation results can be displayed. Heater range and control output as current or power can also be continuously displayed for immediate feedback on control operation.



Normal (Default) Display Configuration

The display provides four reading locations. Readings from each input and the control setpoint can be expressed in any combination of temperature or sensor units, with heater output expressed as a percent of full scale current or power.



Flexible Configuration

Reading locations can be configured by the user to meet application needs. The character preceding the reading indicates input A or B or setpoint S. The character following the reading indicates measurement units or the math function in use.



Curve Entry

The Model 331 display offers the flexibility to support curve, SoftCal™, and zone entry. Curve entry may be performed accurately and to full resolution via the display and keypad as well as computer interface.

1.1 SENSOR SELECTION

Table 1-1. Sensor Temperature Range

		Model	Useful Range	Magnetic Field Use
Diodes	Silicon Diode	DT-670-SD	1.4 K to 500 K	$T \geq 60 \text{ K} \ \& \ B \leq 3 \text{ T}$
	Silicon Diode	DT-670E-BR	30 K to 500 K	$T \geq 60 \text{ K} \ \& \ B \leq 3 \text{ T}$
	Silicon Diode	DT-414	1.4 K to 375 K	$T \geq 60 \text{ K} \ \& \ B \leq 3 \text{ T}$
	Silicon Diode	DT-421	1.4 K to 325 K	$T \geq 60 \text{ K} \ \& \ B \leq 3 \text{ T}$
	Silicon Diode	DT-470-SD	1.4 K to 500 K	$T \geq 60 \text{ K} \ \& \ B \leq 3 \text{ T}$
	Silicon Diode	DT-471-SD	10 K to 500 K	$T \geq 60 \text{ K} \ \& \ B \leq 3 \text{ T}$
	GaAlAs Diode	TG-120-P	1.4 K to 325 K	$T > 4.2 \text{ K} \ \& \ B \leq 5 \text{ T}$
	GaAlAs Diode	TG-120-PL	1.4 K to 325 K	$T > 4.2 \text{ K} \ \& \ B \leq 5 \text{ T}$
	GaAlAs Diode	TG-120-SD	1.4 K to 500 K	$T > 4.2 \text{ K} \ \& \ B \leq 5 \text{ T}$
Positive Temperature Coefficient RTDs	100 Ω Platinum	PT-102/3	14 K to 873 K	$T > 40 \text{ K} \ \& \ B \leq 2.5 \text{ T}$
	100 Ω Platinum	PT-111	14 K to 673 K	$T > 40 \text{ K} \ \& \ B \leq 2.5 \text{ T}$
	Rhodium-Iron	RF-800-4	1.4 K to 500 K	$T > 77 \text{ K} \ \& \ B \leq 8 \text{ T}$
	Rhodium-Iron	RF-100T/U	1.4 K to 325 K	$T > 77 \text{ K} \ \& \ B \leq 8 \text{ T}$
Negative Temperature Coefficient RTDs ²	Cernox™	CX-1010	2 K to 325 K ⁵	$T > 2 \ \& \ B \leq 19 \text{ T}$
	Cernox™	CX-1030-HT	3.5 K to 420 K ^{3,6}	$T > 2 \ \& \ B \leq 19 \text{ T}$
	Cernox™	CX-1050-HT	4 K to 420 K ^{3,6}	$T > 2 \ \& \ B \leq 19 \text{ T}$
	Cernox™	CX-1070-HT	15 K to 420 K ³	$T > 2 \ \& \ B \leq 19 \text{ T}$
	Cernox™	CX-1080-HT	50 K to 420 K ³	$T > 2 \ \& \ B \leq 19 \text{ T}$
	Germanium	GR-200A/B-1000	2.2 K to 100 K ⁴	Not Recommended
	Germanium	GR-200A/B-1500	2.6 K to 100 K ⁴	Not Recommended
	Germanium	GR-200A/B-2500	3.1 K to 100 K ⁴	Not Recommended
	Carbon-Glass	CGR-1-500	4 K to 325 K ⁵	$T > 2 \text{ K} \ \text{to} \ \leq 19 \text{ T}$
	Carbon-Glass	CGR-1-1000	5 K to 325 K ⁵	$T > 2 \text{ K} \ \text{to} \ \leq 19 \text{ T}$
	Carbon-Glass	CGR-1-2000	6 K to 325 K ⁵	$T > 2 \text{ K} \ \text{to} \ \leq 19 \text{ T}$
	Rox™	RX-102A	1.4 K to 40 K ⁵	$T > 2 \text{ K} \ \text{to} \ \leq 10 \text{ T}$
Thermocouples	Type K	9006-006	3.2 K to 1505 K	Not Recommended
	Type E	9006-004	3.2 K to 934 K	Not Recommended
	Chromel-AuFe 0.07%	9006-002	1.2 K to 610 K	Not Recommended

² Single excitation current may limit the low temperature range of NTC resistors.

³ Non-HT version maximum temperature: 325 K.

⁴ Low temperature limited by input resistance range.

⁵ Low temperature specified with self-heating error: $\leq 5 \text{ mK}$.

⁶ Low temperature specified with self-heating error: $\leq 12 \text{ mK}$.

Silicon diodes are the best choice for general cryogenic use from 1.4 K to above room temperature. Diodes are economical to use because they follow a standard curve and are interchangeable in many applications. They are not suitable for use in ionizing radiation or magnetic fields.

Cernox™ thin-film RTDs offer high sensitivity and low magnetic field-induced errors over the 2 K to 420 K temperature range. Cernox sensors require calibration.

Platinum RTDs offer high uniform sensitivity from 30 K to over 800 K. With excellent reproducibility, they are useful as thermometry standards. They follow a standard curve above 70 K and are interchangeable in many applications.

Table 1-2. Typical Sensor Performance

	Example Lake Shore Sensor	Temp	Nominal Resistance/ Voltage	Typical Sensor Sensitivity ⁷	Measurement Resolution: Temperature Equivalents	Electronic Accuracy: Temperature Equivalents	Temperature Accuracy including Electronic Accuracy, CalCurve™, and Calibrated Sensor	Electronic Control Stability ⁸ : Temperature Equivalents
Silicon Diode	DT-670-SD-13 with 1.4H calibration	1.4 K	1.644 V	-12.49 mV/K	0.8 mK	±13 mK	±25 mK	±1.6 mK
		77 K	1.028 V	-1.73 mV/K	5.8 mK	±76 mK	±98 mK	±11.6 mK
		300 K	0.5597 V	-2.3 mV/K	4.4 mK	±47 mK	±79 mK	±8.8 mK
		500 K	0.0907 V	-2.12 mV/K	4.8 mK	±40 mK	±90 mK	±9.6 mK
Silicon Diode	DT-470-SD-13 with 1.4H calibration	1.4 K	1.6981 V	-13.1 mV/K	0.8 mK	±13 mK	±25 mK	±1.6 mK
		77 K	1.0203 V	-1.92 mV/K	5.2 mK	±69 mK	±91 mK	±10.4 mK
		300 K	0.5189 V	-2.4 mV/K	4.2 mK	±45 mK	±77 mK	±8.4 mK
		475 K	0.0906 V	-2.22 mV/K	4.6 mK	±39 mK	±89 mK	±9.2 mK
GaAlAs Diode	TG-120-SD with 1.4H calibration	1.4 K	5.391 V	-97.5 mV/K	0.2 mK	±7 mK	±19 mK	±0.4 mK
		77 K	1.422 V	-1.24 mV/K	16.2 mK	±180 mK	±202 mK	±32.4 mK
		300 K	0.8978 V	-2.85 mV/K	7 mK	±60 mK	±92 mK	±14 mK
		475 K	0.3778 V	-3.15 mV/K	6.4 mK	±38 mK	±88 mK	±12.8 mK
100 Ω Platinum RTD 500 Ω Full Scale	PT-103 with 1.4J calibration	30 K	3.660 Ω	0.191 Ω/K	10.5 mK	±23 mK	±33 mK	±21 mK
		77 K	20.38 Ω	0.423 Ω/K	4.8 mK	±15 mK	±27 mK	±9.6 mK
		300 K	110.35 Ω	0.387 Ω/K	5.2 mK	±39 mK	±62 mK	±10.4 mK
		500 K	185.668 Ω	0.378 Ω/K	5.3 mK	±60 mK	±106 mK	±10.6 mK
Cernox™	CX-1050-SD-HT ⁹ with 4M calibration	4.2 K	3507.2 Ω	-1120.8 Ω/K	36 μK	±1.4 mK	±6.4 mK	±72 μK
		77 K	205.67 Ω	-2.4116 Ω/K	16.6 mK	±76 mK	±92 mK	±33.2 mK
		300 K	59.467 Ω	-0.1727 Ω/K	232 mK	±717 mK	±757 mK	±464 mK
		420 K	45.030 Ω	-0.0829 Ω/K	483 mK	±1.42 K	±1.49 K	±966 mK
Germanium	GR-200A-1000 with 1.4D calibration	2 K	6674 Ω	-9930 Ω/K	4 μK	±0.3 mK	±4.3 mK	±8 μK
		4.2 K	1054 Ω	-526 Ω/K	76 μK	±1 mK	±5 mK	±152 μK
		10 K	170.9 Ω	-38.4 Ω/K	1 mK	±4.4 mK	±9.4 mK	±2 mK
		100 K	2.257 Ω	-0.018 Ω/K	2.22 K	±5.61 K	±5.626 K	±4.44 K
Carbon-Glass	CGR-1-2000 with 4L calibration	4.2 K	2260 Ω	-2060 Ω/K	20 μK	±0.5 mK	±4.5 mK	±40 μK
		77 K	21.65 Ω	-0.157 Ω/K	255 mK	±692 mK	±717 mK	±510 mK
		300 K	11.99 Ω	-0.015 Ω/K	2.667 K	±7 K	±7.1 K	±5.344 K
Thermocouple 50mV	Type K	75 K	-5862.9 μV	15.6 μV/K	26 mK	±0.25 K ¹⁰	Calibration not available from Lake Shore	±52 mK
		300 K	1075.3 μV	40.6 μV/K	10 mK	±0.038 K ¹⁰		±20 mK
		600 K	13325 μV	41.7 μV/K	10 mK	±0.184 K ¹⁰		±20 mK
		1505 K	49998.3 μV	36.006 μV/K	12 mK	±0.73 K ¹⁰		±24 mK

⁷ Typical sensor sensitivities were taken from representative calibrations for the sensor listed

⁸ Control stability of the electronics only, in an ideal thermal system

⁹ Non-HT version maximum temperature: 325 K

¹⁰ Accuracy specification does not include errors from room temperature compensation

1.2 SPECIFICATIONS

Table 1-3. Input Specifications

	Sensor Temperature Coefficient	Input Range	Excitation Current	Display Resolution	Measurement Resolution	Electronic Accuracy	Electronic Control Stability ¹¹
Diode	negative	0 V to 2.5 V	10 μ A \pm 0.05% ^{12,13}	100 μ V	10 μ V	\pm 80 μ V \pm 0.005% of rdg	\pm 20 μ V
	negative	0 V to 7.5 V	10 μ A \pm 0.05% ^{12,13}	100 μ V	20 μ V	\pm 80 μ V \pm 0.01% of rdg	\pm 40 μ V
PTC RTD	positive	0 Ω to 500 Ω	1 mA ¹⁴	10 m Ω	2 m Ω	\pm 0.004 Ω \pm 0.01% of rdg	\pm 4 m Ω
	positive	0 Ω to 5000 Ω	1 mA ¹⁴	100 m Ω	20 m Ω	\pm 0.04 Ω \pm 0.02% of rdg	\pm 40 m Ω
NTC RTD	negative	0 Ω to 7500 Ω	10 μ A \pm 0.05% ¹⁴	100 m Ω	40 m Ω	\pm 0.1 μ V \pm 0.04% of rdg	\pm 80 m Ω
Thermocouple	positive	\pm 25 mV	NA	1 μ V	0.4 μ V	\pm 1 μ V \pm 0.05% of rdg ¹⁵	\pm 0.8 μ V
	positive	\pm 50 mV	NA	1 μ V	0.4 μ V	\pm 1 μ V \pm 0.05% of rdg ¹⁵	\pm 0.8 μ V

- ¹¹ Control stability of the electronics only, in an ideal thermal system
- ¹² Current source error has negligible effect on measurement accuracy
- ¹³ Diode input excitation can be set to 1 mA – refer to Paragraph 4.4.2
- ¹⁴ Current source error is removed during calibration
- ¹⁵ Accuracy specification does not include errors from room temperature compensation

Thermometry

- Number of inputs 2
- Input configuration Each input is factory configured for either diode/RTD or thermocouples
- Isolation Sensor inputs optically isolated from other circuits but not each other
- A/D resolution 24-bit
- Input accuracy Sensor dependent – refer to Input Specifications table
- Measurement resolution Sensor dependent – refer to Input Specifications table
- Maximum update rate 10 readings/s on each input (except 5 readings/s on input A when configured as thermocouple)
- User curves Room for twenty 200-point CalCurves™ or user curves
- SoftCal™ Improves accuracy of DT-470 diode to \pm 0.25 K from 30 K to 375 K; improves accuracy of Platinum RTDs to \pm 0.25 K from 70 K to 325 K – stored as user curves
- Math Maximum, Minimum, and Linear Equation (Mx + B) or M(x+B)
- Filter Averages 2 to 64 input readings

Table 1-4. Sensor Input Configuration

	Diode/RTD	Thermocouple
Measurement type	4-lead differential	2-lead, room temperature compensated
Excitation	Constant current with current reversal for RTDs	NA
Supported sensors	Diodes: Silicon, GaAlAs RTDs: 100 Ω Platinum, 1000 Ω Platinum, Germanium, Carbon-Glass, Cernox™, and Rox™	Most thermocouple types
Standard curves	DT-470, DT-500D, DT-670, PT-100, PT-1000, RX-102A, RX-202A	Type E, Type K, Type T, AuFe 0.07% vs. Cr, AuFe 0.03% vs. Cr
Input connector	6-pin DIN	Ceramic isothermal block

Specifications (Continued)

Control

Control loops	Two on 331S, one on 331E
Control type	Closed loop digital PID with manual heater output, or open loop
Tuning	Autotune (one loop at a time), PID, PID zones
Control stability	Sensor dependent – to 2× measurement resolution (in an ideal thermal system)
PID control parameters	
Proportional (gain)	0 to 1000 with 0.1 setting resolution
Integral (reset)	1 to 1000 (1000/s) with 0.1 setting resolution
Derivative (rate)	1 to 200% with 1% resolution
Manual output	0 to 100% with 0.01% setting resolution
Zone control	10 temperature zones with P, I, D, manual heater out, and heater range
Setpoint ramping	0.1 K/min to 100 K/min
Safety limits	Curve temperature, power up heater off, short circuit protection

Table 1-5. Heater Output

	Loop 1	Loop 2
Heater output type	Variable DC current source	Variable DC voltage source
Heater output D/A resolution	18-bit	16-bit
Max heater power	50 W	1 W
Max heater output current	1 A	0.1 A
Heater output compliance	50 V	10 V
Heater output ranges	3 decade steps in power	1
Heater load type	Resistive	Resistive
Heater load range	10 Ω to 100 Ω recommended	100 Ω minimum
Heater load for max power	50 Ω	100 Ω
Heater noise (<1 kHz) RMS	50 μV + 0.01% of output voltage	<0.3 mV
Isolation	Optical isolation between output and other circuits	None
Heater connector	Dual banana	Detachable terminal block

Table 1-6. Loop 1 Full Scale Heater Power at Typical Resistance

Heater Resistance	Heater Range	Heater Power
10 Ω	Low	100 mW
	Med	1 W
	High	10 W
25 Ω	Low	250 mW
	Med	2.5 W
	High	25 W
50 Ω	Low	500 mW
	Med	5 W
	High	50 W

Specifications (Continued)

Front Panel

Display	2 line by 20 character, 9 mm character height, vacuum fluorescent display
Number of reading displays	1 to 4
Display units	K, °C, V, mV, Ω
Reading source	Temperature, sensor units, max, min, and linear equation
Display update rate	All readings twice per s
Temp display resolution	0.001° from 0° to 99.999°, 0.01° from 100° to 999.99°, 0.1° above 1000°
Sensor units display resolution	Sensor dependent to 5 digits
Other displays	Setpoint, Heater Range, and Heater Output (user selected)
Setpoint setting resolution	Same as display resolution (actual resolution is sensor dependent)
Heater output display	Numeric display in percent of full scale for power or current
Heater output resolution	1%
Display annunciators	Control Input, Remote, Alarm, Tuning, Ramp, Max, Min, Linear
Keypad	20 full travel keys, numeric and specific functions
Front panel features	Front panel curve entry, display brightness control, keypad lock-out

Interface

IEEE-488 interface (331S)	
Features	SH1, AH1, T5, L4, SR1, RL1, PP0, DC1, DT0, C0, E1
Reading rate	To 10 readings per s on each input
Software support	LabVIEW™ driver (consult factory for availability)
Serial interface	
Electrical format	RS-232C
Max baud rate	9600 baud
Connector	9-pin D-sub
Reading rate	To 10 readings/s on each input (at 9600 baud)
Special interface features	Model 330 command emulation mode
Alarms	
Number	4, high and low for each input
Data source	Temperature, Sensor Units, Linear Equation
Settings	Source, High Setpoint, Low Setpoint, Deadband, Latching or Non-Latching, Audible On/Off
Actuators	Display annunciator, beeper, relays
Relays (331S)	
Number	2
Contacts	Normally Open (NO), Normally Closed (NC), and Common (C)
Contact rating	30 VDC at 5 A
Operation	Activate relays on high, low, or both alarms for either input or manual
Connector	Detachable terminal block
Analog voltage output (331S)	
Scale	User selected
Update rate	10 readings per s
Data source	Temperature, Sensor Units, Linear Equation
Settings	Input, source, top of scale, bottom of scale, or manual
Range	±10 V
Resolution	0.3 mV
Accuracy	±2.5 mV
Min load resistance	100 Ω (short circuit protected)

Specifications (Continued)

General

Ambient temperature	15 °C to 35 °C at rated accuracy, 10 °C to 40 °C at reduced accuracy
Power requirement	100, 120, 220, 240 VAC, (+6%, -10%), 50 or 60 Hz, 120 VA
Size	216 mm W × 89 mm H × 368 mm D (8.5 in × 3.5 in × 14.5 in), half rack
Weight	4.8 kg (10.5 lb)
Approval	CE mark

Product Configuration

Part Number *Description (Input configuration cannot be changed in the field)*

Standard Temperature Controllers, all features included:

331S	Two Diode/Resistor Inputs
331S-T1	One Diode/Resistor, One Thermocouple Input
331S-T2	Two Thermocouple Inputs

Economy Temperature Controllers, all features of the 331S except does not include the following:
IEEE-488, relays, analog voltage output, second control loop.

331E	Two Diode/Resistor Inputs
331E-T1	One Diode/Resistor, One Thermocouple Input
331E-T2	Two Thermocouple Inputs

Refer to Chapter 7 of this manual for a complete description of Model 331 options and accessories. Specifications subject to change without notice.

1.3 SAFETY SUMMARY

Observe these general safety precautions during all phases of instrument operation, service, and repair. Failure to comply with these precautions or with specific warnings elsewhere in this manual violates safety standards of design, manufacture, and intended instrument use. Lake Shore Cryotronics, Inc. assumes no liability for Customer failure to comply with these requirements.

The Model 331 protects the operator and surrounding area from electric shock or burn, mechanical hazards, excessive temperature, and spread of fire from the instrument. Environmental conditions outside of the conditions below may pose a hazard to the operator and surrounding area.

- Indoor use.
- Altitude to 2000 meters.
- Temperature for safe operation: 5 °C to 40 °C.
- Maximum relative humidity: 80% for temperature up to 31 °C decreasing linearly to 50% at 40 °C.
- Power supply voltage fluctuations not to exceed ±10% of the nominal voltage.
- Overvoltage category II.
- Pollution degree 2.

Ground The Instrument

To minimize shock hazard, the instrument is equipped with a three-conductor AC power cable. Plug the power cable into an approved three-contact electrical outlet or use a three-contact adapter with the grounding wire (green) firmly connected to an electrical ground (safety ground) at the power outlet. The power jack and mating plug of the power cable meet Underwriters Laboratories (UL) and International Electrotechnical Commission (IEC) safety standards.

Safety Summary (Continued)

Ventilation

The instrument has ventilation holes in its side covers. Do not block these holes when the instrument is operating.

Do Not Operate In An Explosive Atmosphere

Do not operate the instrument in the presence of flammable gases or fumes. Operation of any electrical instrument in such an environment constitutes a definite safety hazard.

Keep Away From Live Circuits

Operating personnel must not remove instrument covers. Refer component replacement and internal adjustments to qualified maintenance personnel. Do not replace components with power cable connected. To avoid injuries, always disconnect power and discharge circuits before touching them.













Do Not Substitute Parts Or Modify Instrument

Do not install substitute parts or perform any unauthorized modification to the instrument. Return the instrument to an authorized Lake Shore Cryotronics, Inc. representative for service and repair to ensure that safety features are maintained.

Cleaning

Do not submerge instrument. Clean only with a damp cloth and mild detergent. Exterior only.

1.4 SAFETY SYMBOLS

	Direct current (power line).		Equipment protected throughout by double insulation or reinforced insulation (equivalent to Class II of IEC 536 - see Annex H).
	Alternating current (power line).		Caution: High voltages; danger of electric shock. Background color: Yellow; Symbol and outline: Black.
	Alternating or direct current (power line).		Caution or Warning - See instrument documentation. Background color: Yellow; Symbol and outline: Black.
	Three-phase alternating current (power line).		Fuse.
	Earth (ground) terminal.		
	Protective conductor terminal.		
	Frame or chassis terminal.		
	On (supply).		
	Off (supply).		

CHAPTER 2

COOLING SYSTEM DESIGN

2.0 GENERAL

Selecting the proper cryostat or cooling source is probably the most important decision in designing a temperature control system. The cooling source defines minimum temperature, cool-down time, and cooling power. (Information on choosing a cooling source is beyond the scope of this manual.) This chapter provides information on how to get the best temperature measurement and control from cooling sources with proper setup including sensor and heater installation.

Chapter 2 contains the following major topics. Temperature sensor selection is covered in Paragraph 2.1. Calibrated sensors are covered in Paragraph 2.2. Sensor installation is covered in Paragraph 2.3. Heater selection and installation is covered in Paragraph 2.4. Considerations for good control are covered in Paragraph 2.5. PID Control is covered in Paragraph 2.6. Manual Tuning is covered in Paragraph 2.7. AutoTuning is covered in Paragraph 2.8. Finally, Zone Tuning is covered in Paragraph 2.9.

2.1 TEMPERATURE SENSOR SELECTION

This section attempts to answer some of the basic questions concerning temperature sensor selection. Additional useful information on temperature sensor selection is available in the Lake Shore Temperature Measurement and Control Catalog. The catalog has a large reference section that includes sensor characteristics and sensor selection criteria.

2.1.1 Temperature Range

Several important sensor parameters must be considered when choosing a sensor. The first is temperature range. The experimental temperature range must be known when choosing a sensor. Some sensors can be damaged by temperatures that are either too high or too low. Manufacturer recommendations should always be followed.

Sensor sensitivity is also dependent on temperature and can limit the useful range of a sensor. It is important not to specify a range larger than necessary. If an experiment is being done at liquid helium temperature, a very high sensitivity is needed for good measurement resolution at that temperature. That same resolution may not be required to monitor warm up to room temperature. Two different sensors may be required to tightly cover the range from helium to room temperature, but lowering the resolution requirement on warm up may allow a less expensive, one sensor solution.

Another thing to consider when choosing a temperature sensor is that instruments like the Model 331 are not able to read some sensors over their entire temperature range. Lake Shore sells calibrated sensors that operate down to 50 millikelvin (mK), but the Model 331 is limited to above 1 K in its standard configuration.

2.1.2 Sensor Sensitivity

Temperature sensor sensitivity is a measure of how much a sensor signal changes when the temperature changes. It is an important sensor characteristic because so many measurement parameters are related to it. Resolution, accuracy, noise floor, and even control stability depend on sensitivity. Many sensors have different sensitivities at different temperatures. For example, a platinum sensor has good sensitivity at higher temperatures but has limited use below 30 kelvin (K) because its sensitivity drops sharply. It is difficult to determine if a sensor has adequate sensitivity over the experimental temperature range. This manual has specifications (Table 1-3) that include sensor sensitivity translated into temperature resolution and accuracy at different points. This is typical sensor response and can be used as a guide when choosing a sensor to be used with the Model 331.

2.1.3 Environmental Conditions

The experimental environment is also important when choosing a sensor. Environmental factors such as high vacuum, magnetic field, corrosive chemicals, or even radiation can limit the use of some types of sensors. Lake Shore has devoted much time to developing sensor packages that withstand the temperatures, vacuum levels, and bonding materials found in typical cryogenic cooling systems.

Experiments done in magnetic fields are becoming very common. Field dependence of temperature sensors is an important selection criteria for sensors used in these experiments. This manual briefly qualifies the field dependence of most common sensors in the specifications (Table 1-3). Detailed field dependence tables are included in the Lake Shore Temperature Measurement and Control Catalog. When available, specific data on other environmental factors is also included in the catalog.

2.1.4 Measurement Accuracy

Temperature measurements have several sources of error that reduce accuracy. Be sure to account for errors induced by both the sensor and the instrumentation when computing accuracy. The instrument has measurement error in reading the sensor signal and error in calculating a temperature using a temperature response curve. Error results from the sensor being compared to a calibration standard and the temperature response of a sensor will shift with time and with repeated thermal cycling (from very cold temperatures to room temperature). Instrument and sensor makers specify these errors but there are things a user can do to maintain good accuracy. For example, choose a sensor that has good sensitivity in the most critical temperature range, as sensitivity can minimize the effect of most error sources. Install the sensor properly following guidelines in Paragraph 2.3. Have the sensor and instrument periodically recalibrated, or in some other way null the time dependent errors. Use a sensor calibration that is appropriate for the accuracy requirement.

2.1.5 Sensor Package

Many types of sensors can be purchased in different packages. Some types of sensors can even be purchased as bare chips; without any package. A sensor package generally determines its size, thermal and electrical contact to the outside, and sometimes limits temperature range. When different packages are available for a sensor, the user should consider the mounting surface for the sensor and how leads will be heat sunked when choosing.

2.2 CALIBRATED SENSORS

There can sometimes be confusion in the difficult task of choosing the right sensor, getting it calibrated, translating the calibration data into a temperature response curve that the Model 331 can understand, then getting the curve loaded into the instrument. Lake Shore provides a variety of calibration and curve loading services to fit different accuracy requirements and budgets.

2.2.1 Traditional Calibration

Calibration is done by comparing a sensor with an unknown temperature response to an accepted standard. Lake Shore temperature standards are traceable to the U.S. National Institute of Standards and Testing (NIST) or the National Physical Laboratory in Great Britain. These standards allow Lake Shore to calibrate sensors from 50 mK to above room temperature. Calibrated sensors are more expensive than uncalibrated sensors of the same type because of the labor and capitol equipment used in the process.

This type of calibration provides the most accurate temperature sensors available from Lake Shore. Errors from sensor calibration are almost always smaller than the error contributed by the Model 331. The Lake Shore Temperature Measurement and Control Catalog has complete accuracy specifications for calibrated sensors.

Traditional Calibration (Continued)

Calibrated sensors include the measured test data printed and plotted, the coefficients of a Chebychev polynomial that has been fitted to the data, and two tables of data points to be used as interpolation tables. Both interpolation tables are optimized to allow accurate temperature conversion. The smaller table, called a breakpoint interpolation table, is sized to fit into instruments like the Model 331 where it is called a temperature response curve. Getting a curve into a Model 331 may require a CalCurve™ described below or hand entering through the instrument front panel.

It is important to look at instrument specifications before ordering calibrated sensors. A calibrated sensor is required when a sensor does not follow a standard curve *if* the user wishes to display in temperature. Otherwise the Model 331 will operate in sensor units like ohms or volts. The Model 331 may not work over the full temperature range of some sensors. The standard inputs in are limited to operation above 1 K even with sensors that can be calibrated to 50 mK.

2.2.2 SoftCal™

SoftCal is a good solution for applications that do not require the accuracy of a traditional calibration. The SoftCal algorithm uses the well behaved nature of sensors that follow a standard curve to improve the accuracy of individual sensors. A few known temperature points are required to perform SoftCal.

Lake Shore sells SoftCal calibrated sensors that include both the large interpolation table and the smaller breakpoint interpolation table. A CalCurve may be required to get the breakpoint table into a Model 331 where it is called a temperature response curve. Refer to Paragraph 2.2.4.

The Model 331 can also perform a SoftCal calibration. The user must provide one, two, or three known temperature reference points. The range and accuracy of the calibration is based on these points. Refer to Paragraph 5.3.

2.2.3 Standard Curves

Some types of sensors behave in a very predictable manner and a standard temperature response curve can be created for them. Standard curves are a convenient and inexpensive way to get reasonable temperature accuracy. Sensors that have a standard curve are often used when interchangeability is important. Some individual sensors are selected for their ability to match a published standard curve and sold at a premium, but in general these sensors do not provide the accuracy of a calibrated sensor. For convenience, the Model 331 has several standard curves included in firmware.

2.2.4 CalCurve™

The CalCurve service provides the user with a convenient way get the temperature response curve from Lake Shore calibrated sensors into instruments like the Model 331. It can be performed at the factory when calibrated sensors and instruments are ordered together. The factory installed CalCurve option is Model 8001-331 and should be ordered with the calibrated sensor. A CalCurve can be done in the field when additional or replacement sensors are installed. Curve data is loaded into some type of non-volatile memory that is installed into the instrument by the user. In the case of the Model 331, the curve is loaded into a non-volatile memory which can be installed into the instrument. The field installed version is a Model 8002-05-331 and should be ordered with the calibrated sensor. Customers that have a PC-compatible computer with an RS-232C or IEEE-488 interface have another option. The Model 8000 is included with the calibrated sensor and can be loaded by the user.

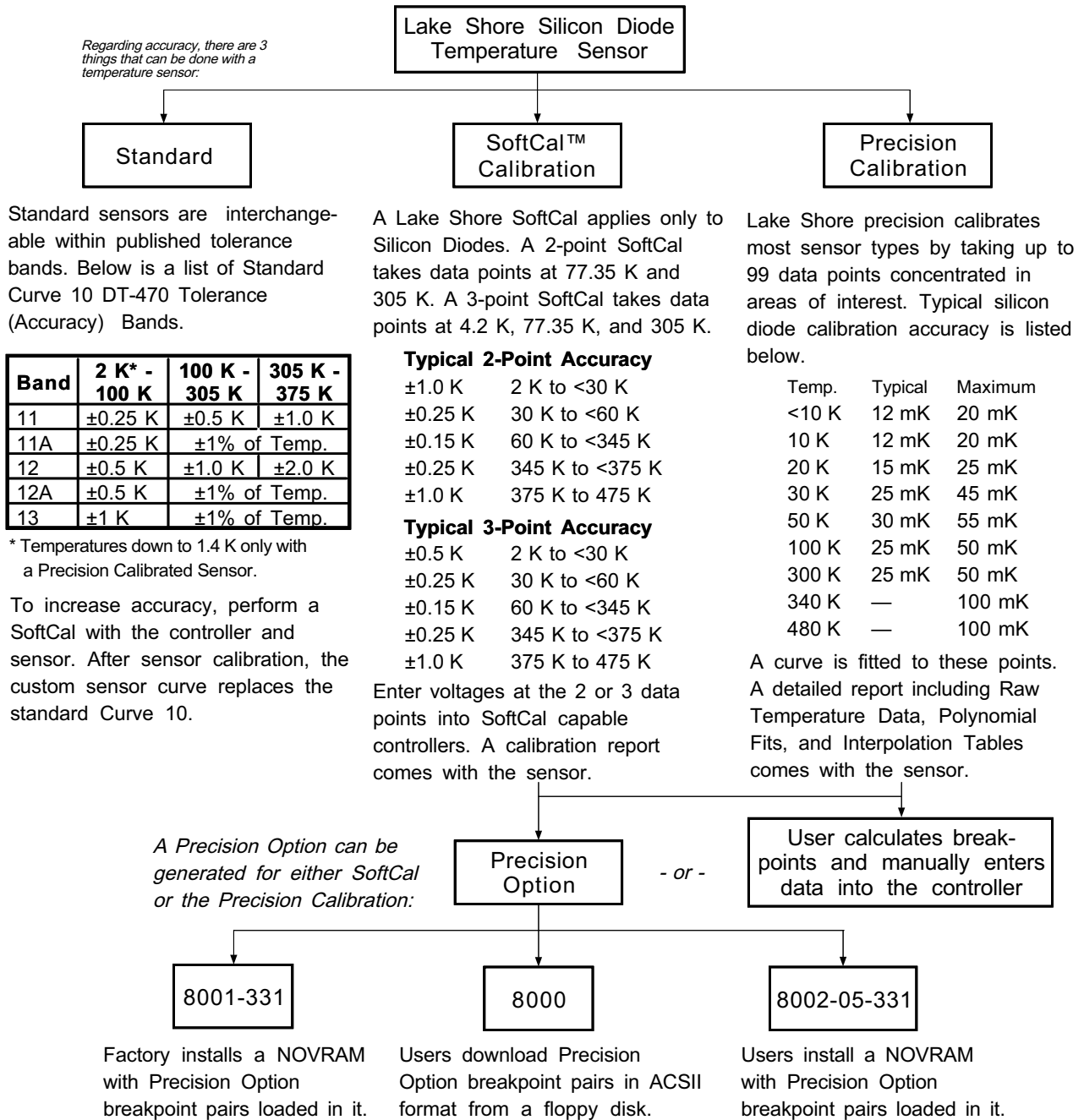

C-331-2-1.eps

Figure 2-1. Silicon Diode Sensor Calibrations and CalCurve

2.3 SENSOR INSTALLATION

This section highlights some of the important elements of proper sensor installation. For more detailed information, Lake Shore sensors are shipped with installation instructions that cover that specific sensor type and package. The Lake Shore Temperature Measurement and Control Catalog includes an installation section as well. To further help users properly install sensors, Lake Shore offers a line of Cryogenic Accessories. Many of the materials discussed are available through Lake Shore and can be ordered with sensors or instruments.

2.3.1 Mounting Materials

Choosing appropriate mounting materials is very important in a cryogenic environment. The high vacuum used to insulate cryostats is one source of problems. Materials used in these applications should have a low vapor pressure so they do not evaporate or out-gas and spoil the vacuum insulation. Metals and ceramics do not have this problem but greases and varnishes must be checked. Another source of problems is the wide extremes in temperature most sensors are exposed to. The linear expansion coefficient of a materials becomes important when temperature changes are so large. Never try to permanently bond materials with linear expansion coefficients that differ by more than three. A flexible mounting scheme should be used or the parts will break apart, potentially damaging them. The thermal expansion or contraction of rigid clamps or holders could crush fragile samples or sensors that do not have the same coefficient. Thermal conductivity is a property of materials that can change with temperature. Do not assume that a heat sink grease that works well at room temperature and above will do the same job at low temperatures.

2.3.2 Sensor Location

Finding a good place to mount a sensor in an already crowded cryostat is never easy. There are less problems if the entire load and sample holder are at the same temperature. Unfortunately, this not the case in many systems. Temperature gradients (differences in temperature) exist because there is seldom perfect balance between the cooling source and heat sources. Even in a well-controlled system, unwanted heat sources like thermal radiation and heat conducting through mounting structures can cause gradients. For best accuracy, sensors should be positioned near the sample, so that little or no heat flows between the sample and sensor. This may not, however, be the best location for temperature control as discussed below.

2.3.3 Thermal Conductivity

The ability of heat to flow through a material is called thermal conductivity. Good thermal conductivity is important in any part of a cryogenic system that is intended to be the same temperature. Copper and aluminum are examples of metals that have good thermal conductivity, while stainless steel does not. Non-metallic, electrically-insulating materials like alumina oxide and similar ceramics have good thermal conductivity, while G-10 epoxy-impregnated fiberglass does not. Sensor packages, cooling loads, and sample holders should have good thermal conductivity to reduce temperature gradients. Surprisingly, the connections between thermally conductive mounting surfaces often have very poor thermal conductivity.

2.3.4 Contact Area

Thermal contact area greatly affects thermal conduction because a larger area has more opportunity to transfer heat. Even when the size of a sensor package is fixed, thermal contact area can be improved with the use of a gasket material. A soft gasket material forms into the rough mating surface to increase the area of the two surfaces that are in contact. Good gasket materials are soft, thin, and have good thermal conductivity. They must also withstand the environmental extremes. Indium foil and cryogenic grease are good examples.

2.3.5 Contact Pressure

When sensors are permanently mounted, the solder or epoxy used to hold the sensor act as both gasket and adhesive. Permanent mounting is not a good solution for everyone because it limits flexibility and can potentially damage sensors. Much care should be taken not to over heat or mechanically stress sensor packages. Less permanent mountings require some pressure to hold the sensor to its mounting surface. Pressure greatly improves the action of gasket material to increase thermal conductivity and reduce thermal gradients. A spring clamp is recommended so that different rates of thermal expansion do not increase or decrease pressure with temperature change.

2.3.6 Lead Wire

Different types of sensors come with different types and lengths of electrical leads. In general a significant length of lead wire must be added to the sensor for proper heat sinking and connecting to a bulk head connector at the vacuum boundary. The lead wire must be a good electrical conductor, but should not be a good *thermal* conductor, or heat will transfer down the leads and change the temperature reading of the sensor. Small 30 to 40 AWG wire made of an alloy like phosphor bronze is much better than copper wire. Thin wire insulation is preferred and twisted wire should be used to reduce the effect of RF noise if it is present. The wire used on the room temperature side of the vacuum boundary is not critical so copper cable is normally used.

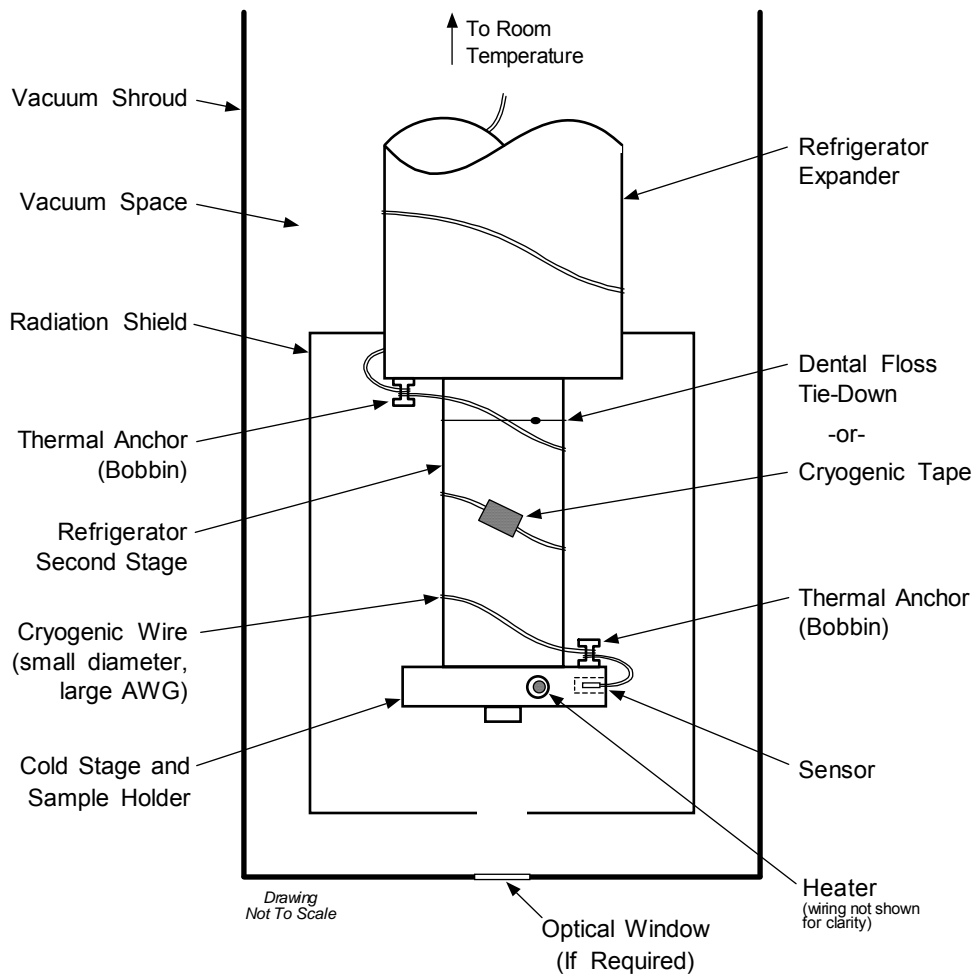

P-331-2-2.bmp

Figure 2-2. Typical Sensor Installation In A Mechanical Refrigerator

2.3.7 Lead Soldering

When additional wire is soldered to short sensor leads, care must be taken not to overheat the sensor. A heat sink such as a metal wire clamp or alligator clip will heat sink the leads and protect the sensor. Leads should be tinned before bonding to reduce the time that heat is applied to the sensor lead. Solder flux should be cleaned after soldering to prevent corrosion.

2.3.8 Heat Sinking Leads

Sensor leads can be a significant source of error if they are not properly heat sunk. Heat will transfer down even small leads and alter the sensor reading. The goal of heat sinking is to cool the leads to a temperature as close to the sensor as possible. This can be accomplished by putting a significant length of lead wire in thermal contact with every cooled surface between room temperature and the sensor. Lead wires can be adhered to cold surfaces with varnish over a thin electrical insulator like cigarette paper. They can also be wound onto a bobbin that is firmly attached to the cold surface. Some sensor packages include a heat sink bobbin and wrapped lead wires to simplify heat sinking.

2.3.9 Thermal Radiation

Thermal (black body) radiation is one of the ways heat is transferred. Warm surfaces radiate heat to cold surfaces even through a vacuum. The difference in temperature between the surfaces is one thing that determines how much heat is transferred. Thermal radiation causes thermal gradients and reduces measurement accuracy. Many cooling systems include a radiation shield. The purpose of the shield is to surround the load, sample, and sensor with a surface that is at or near their temperature to minimize radiation. The shield is exposed to the room temperature surface of the vacuum shroud on its outer surface, so some cooling power must be directed to the shield to keep it near the load temperature. If the cooling system does not include an integrated radiation shield (or one cannot be easily made), one alternative is to wrap several layers of super-insulation (aluminized Mylar) loosely between the vacuum shroud and load. This reduces radiation transfer to the sample space.

2.4 HEATER SELECTION AND INSTALLATION

There is a variety of resistive heaters that can be used as the controlled heating source for temperature control. The mostly metal alloys like nichrome are usually wire or foil. Shapes and sizes vary to permit installation into different systems.

2.4.1 Heater Resistance and Power

Cryogenic cooling systems have a wide range of cooling power. The resistive heater must be able to provide sufficient heating power to warm the system. The Model 331 can supply up to 50 W of power to a heater (if the heater resistance is appropriate). The Model 331 heater output current source has a maximum output of 1 A, limiting maximum power to:

$$\text{Max Power (watts)} = (1 \text{ ampere})^2 \times \text{Resistance (ohms)}.$$

Even though the Model 331 output is a current source, it has a voltage limit (called the compliance voltage) of 50 V, which also limits maximum power:

$$\text{Max Power (watts)} = \frac{(50 \text{ volts})^2}{\text{Resistance (ohms)}}.$$

Both limits are in place at the same time, so the smallest of the two computations gives the maximum power available to the heater. A heater of 50 Ω allows the instrument to provide its maximum power of 50 watts. A typical smaller resistance of 25 Ω allows 25 watts of power, while a typical larger resistance of 100 Ω is limited by compliance voltage to 25 watts. The resistor chosen as a heater must be able to withstand the power being dissipated in it. Pre-packaged resistors have a power specification that is usually given for the resistor in free air. This power may need to be derated if used in a vacuum where convection cooling can not take place and it is not adequately heat sunk to a cooled surface.

2.4.2 Heater Location

For best temperature measurement accuracy the heater should be located so that heat flow between the cooling power and heater is minimized. For best control the heater should be in close thermal contact with the cooling power. Geometry of the load can make one or both of these difficult to achieve. That is why there are several heater shapes and sizes.

2.4.3 Heater Types

Resistive wire like nichrome is the most flexible type of heater available. The wire can be purchased with electrical insulation and has a predictable resistance per given length. This type of heater wire can be wrapped around a cooling load to give balanced, even heating of the area. Similar to sensor lead wire, the entire length of the heater wire should be in good thermal contact with the load to allow for thermal transfer. Heat sinking also protects the wire from over heating and burning out.

Resistive heater wire is also wound into cartridge heaters. Cartridge heaters are more convenient but are bulky and more difficult to place on small loads. A typical cartridge is 1/4 inch in diameter and 1 inch long. The cartridge should be snugly held in a hole in the load or clamped to a flat surface. Heat sinking for good thermal contact is again important.

Foil heaters are thin layers of resistive material adhered to, or screened on to, electrically insulating sheets. There are a variety of shapes and sizes. The proper size heater can evenly heat a flat surface or around a round load. The entire active area should be in good thermal contact with the load, not only for maximum heating effect, but to keep spots in the heater from over heating and burning out.

2.4.4 Heater Wiring

When wiring inside a vacuum shroud, we recommend using 30 AWG copper wire for heater leads. Too much heat can leak in when larger wire is used. Heat sinking, similar to that used for the sensor leads, should be included so that any heat leaking in does not warm the load when the heater is not running. The lead wires should be twisted to minimize noise coupling between the heater and other leads in the system. When wiring outside the vacuum shroud, larger gage copper cable can be used, and twisting is still recommended.

2.5 CONSIDERATION FOR GOOD CONTROL

Most of the techniques discussed above to improve cryogenic temperature accuracy apply to control as well. There is an obvious exception in sensor location. A compromise is suggested below in Paragraph 2.5.3 – Two Sensor Approach.

2.5.1 Thermal Conductivity

Good thermal conductivity is important in any part of a cryogenic system that is intended to be at the same temperature. Most systems begin with materials that have good conductivity themselves, but as sensors, heaters, sample holders, etc., are added to an ever more crowded space, the junctions between parts are often overlooked. In order for control to work well, junctions between the elements of the control loop must be in close thermal contact and have good thermal conductivity. Gasket materials should always be used along with reasonable pressure.

2.5.2 Thermal Lag

Poor thermal conductivity causes thermal gradients that reduce accuracy and also cause thermal lag that make it difficult for controllers to do their job. Thermal lag is the time it takes for a change in heating or cooling power to propagate through the load and get to the feedback sensor. Because the feedback sensor is the only thing that lets the controller know what is happening in the system, slow information to the sensor slows the response time. For example, if the temperature at the load drops slightly below the setpoint, the controller gradually increases heating power. If the feedback information is slow, the controller puts too much heat into the system before it is told to reduce heat. The excess heat causes a temperature overshoot, which degrades control stability. The best way to improve thermal lag is to pay close attention to thermal conductivity both in the parts used and their junctions.

2.5.3 Two-Sensor Approach

There is a conflict between the best sensor location for measurement accuracy and the best sensor location for control. For measurement accuracy the sensor should be very near the sample being measured which is away from the heating and cooling sources to reduce heat flow across the sample and thermal gradients. The best control stability is achieved when the feedback sensor is near both the heater and cooling source to reduce thermal lag. If both control stability and measurement accuracy are critical it may be necessary to use two sensors, one for each function. Many temperature controllers including the Model 331 have two sensor inputs for this reason.

2.5.4 Thermal Mass

Cryogenic designers understandably want to keep the thermal mass of the load as small as possible so the system can cool quickly and improve cycle time. Small mass can also have the advantage of reduced thermal gradients. Controlling a very small mass is difficult because there is no buffer to adsorb small changes in the system. Without buffering, small disturbances can very quickly create large temperature changes. In some systems it is necessary to add a small amount of thermal mass such as a copper block in order to improve control stability.

2.5.5 System Nonlinearity

Because of nonlinearities in the control system, a system controlling well at one temperature may not control well at another temperature. While nonlinearities exist in all temperature control systems, they are most evident at cryogenic temperatures. When the operating temperature changes the behavior of the control loop, the controller must be retuned. As an example, a thermal mass acts differently at different temperatures. The specific heat of the load material is a major factor in thermal mass and the specific heat of materials like copper change as much as three orders of magnitude when cooled from 100 K to 10 K. Changes in cooling power and sensor sensitivity are also sources of nonlinearity.

The cooling power of most cooling sources also changes with load temperature. This is very important when operating at temperatures near the highest or lowest temperature that a system can reach. Nonlinearities within a few degrees of these high and low temperatures make it very difficult to configure them for stable control. If difficulty is encountered, it is recommended to gain experience with the system at temperatures several degrees away from the limit and gradually approach it in small steps.

Keep an eye on temperature sensitivity. Sensitivity not only affects control stability but it also contributes to the overall control system gain. The large changes in sensitivity that make some sensors so useful may make it necessary to retune the control loop more often.

2.6 PID CONTROL

For closed-loop operation, the Model 331 temperature controller uses a algorithm called PID control. The control equation for the PID algorithm has three variable terms: proportional (P), integral (I), and derivative (D). See Figure 2-3. Changing these variables for best control of a system is called tuning. The PID equation in the Model 331 is:

$$\text{Heater Output} = P \left[e + I \int (e) dt + D \frac{de}{dt} \right]$$

where the error (e) is defined as: $e = \text{Setpoint} - \text{Feedback Reading}$.

Proportional is discussed in Paragraph 2.6.1. Integral is discussed in Paragraph 2.6.2. Derivative is discussed in Paragraph 2.6.3. Finally, the manual heater output is discussed in Paragraph 2.6.4.

2.6.1 Proportional (P)

The Proportional term, also called gain, must have a value greater than zero for the control loop to operate. The value of the proportional term is multiplied by the error (e) which is defined as the difference between the setpoint and feedback temperatures, to generate the proportional contribution to the output: $Output (P) = Pe$. If proportional is acting alone, with no integral, there must always be an error or the output will go to zero. A great deal must be known about the load, sensor, and controller to compute a proportional setting (P). Most often, the proportional setting is determined by trial and error. The proportional setting is part of the overall control loop gain, and so are the heater range and cooling power. The proportional setting will need to change if either of these change.

2.6.2 Integral (I)

In the control loop, the integral term, also called reset, looks at error over time to build the integral contribution to the output:

$$Output (I) = PI \int (e) dt.$$

By adding the integral to proportional contributions, the error that is necessary in a proportional only system can be eliminated. When the error is at zero, controlling at the setpoint, the output is held constant by the integral contribution. The integral setting (I) is more predictable than the gain setting. It is related to the dominant time constant of the load. As discussed in Paragraph 2.7.3, measuring this time constant allows a reasonable calculation of the integral setting. In the Model 331, the integral term is not set in seconds like some other systems. The integral setting can be derived by dividing 1000 by the integral seconds: $I_{\text{setting}} = 1000 / I_{\text{seconds}}$.

2.6.3 Derivative (D)

The derivative term, also called rate, acts on the change in error with time to make its contribution to the output:

$$Output (D) = PD \frac{de}{dt}.$$

By reacting to a fast changing error signal the derivative can work to boost the output when the setpoint changes quickly, reducing the time it takes for temperature to reach the setpoint. It can also see the error decreasing rapidly when the temperature nears the setpoint and reduce the output for less overshoot. The derivative term can be useful in fast changing systems but it is often turned off during steady state control because it reacts too strongly to small disturbances. The derivative setting (D) is related to the dominant time constant of the load similar to the I_{setting} and is therefore set proportional to I_{setting} when used.

2.6.4 Manual Heater Power (MHP) Output

The Model 331 has a control setting that is not a normal part of a PID control loop. Manual Heater Power (MHP) output can be used for open loop control, meaning feedback is ignored and the heater output stays at the users manual setting. This is a good way to put constant heating power into a load when needed. The MHP output term can also be added to the PID output. Some users prefer to set a power near that necessary to control at a setpoint and let the closed loop make up the small difference. MHP output is set in percent of full scale current or power for a given heater range.

NOTE: MHP output should be set to 0% when not in use.

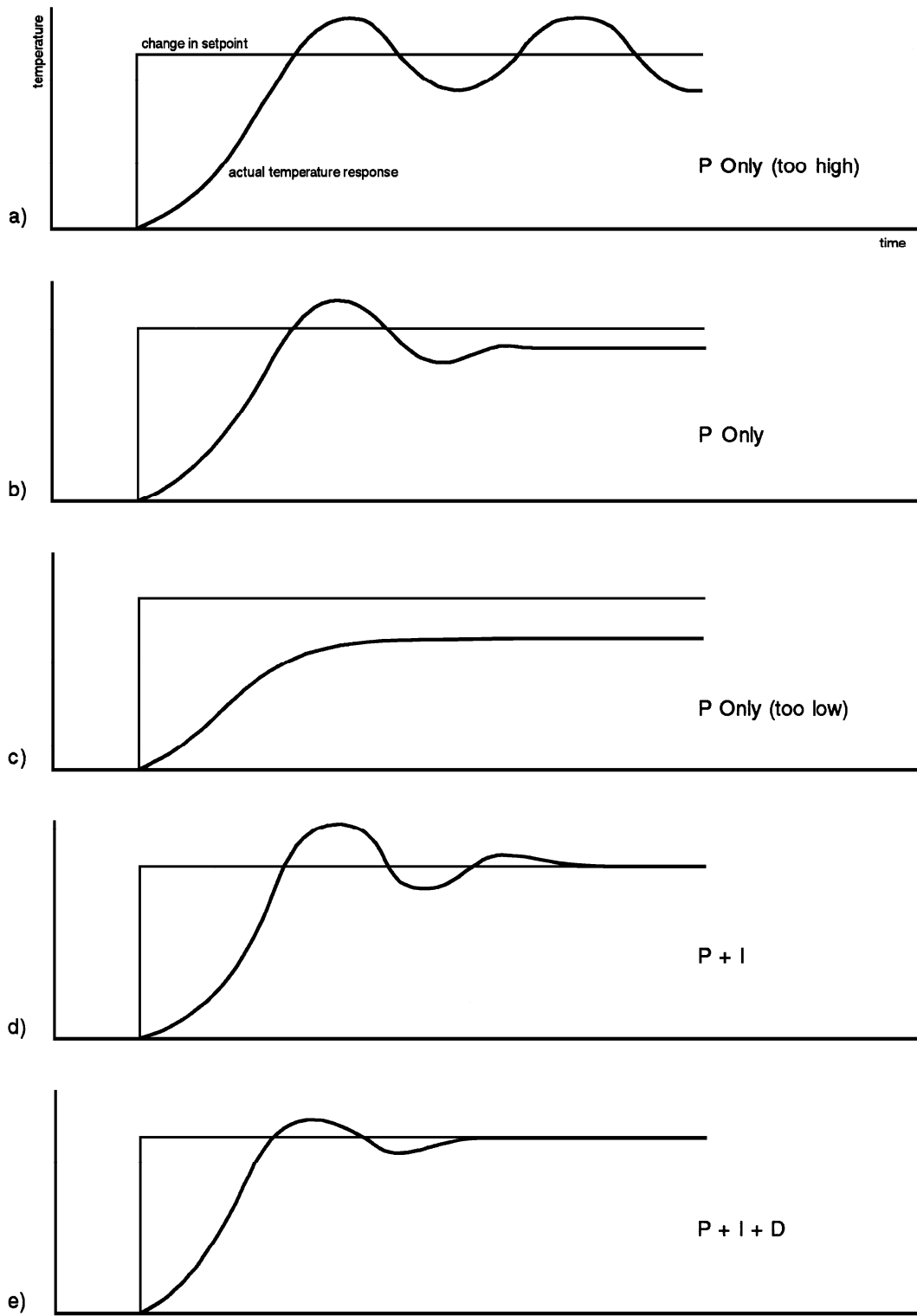

P-331-2-3.bmp

Figure 2-3. Examples of PID Control

2.7 MANUAL TUNING

There has been a lot written about tuning closed loop control systems and specifically PID control loops. This section does not attempt to compete with control theory experts. It describes a few basic rules of thumb to help less experienced users get started. This technique will not solve every problem, but it has worked for many others in the field. This section assumes the user has worked through the operation sections of this manual, has a good temperature reading from the sensor chosen as a control sensor, and is operating Loop 1. It is also a good idea to begin at the center of the temperature range of the cooling system (not close to its highest or lowest temperature). AutoTune (Paragraph 2.8) is another good place to begin, and do not forget the power of trial and error.

2.7.1 Setting Heater Range

Setting an appropriate heater output range is an important first part of the tuning process. *The heater range should allow enough heater power to comfortably overcome the cooling power of the cooling system.* If the heater range will not provide enough power, the load will not be able to reach the setpoint temperature. If the range is set too high, the load may have very large temperature changes that take a long time to settle out. Delicate loads can even be damaged by too much power.

Often there is little information on the cooling power of the cooling system at the desired setpoint. If this is the case, try the following: Allow the load to cool completely with the heater off. Set manual heater power output to 50% while in Open Loop control mode. Turn the heater to the lowest range and write down the temperature rise (if any). Select the next highest heater range and continue the process until the load warms up to room temperature. Do not leave the system unattended, the heater may have to be turned off manually to prevent overheating. If the load never reaches room temperature, some adjustment may be needed in heater resistance or load.

The list of heater range versus load temperature is a good reference for selection the proper heater range. It is common for systems to require two or more heater ranges for good control over their full temperature. Lower heater ranges are normally needed for lower temperature. The Model 331 is of no use controlling at or below the temperature reached when the heater was off. Many systems can be tuned to control within a degree or two above that temperature.

2.7.2 Tuning Proportional

The proportional setting is so closely tied to heater range that they can be thought of as fine and course adjustments of the same setting. An appropriate heater range must be known before moving on to the proportional setting.

Begin this part of the tuning process by letting the cooling system cool and stabilize with the heater off. Place the Model 331 in closed loop control mode with manual PID tuning, then turn integral, derivative and manual output settings off. Enter a setpoint several degrees above the cooling systems lowest temperature. Enter a low proportional setting of approximately 5 or 10 and then enter the appropriate heater range as described above. The heater display should show a value greater than zero and less than 100%. The load temperature should stabilize at a temperature below the setpoint. If the load temperature and heater meter swing rapidly, the heater range may be set too high and should be reduced. Very slow changes in load temperature that could be described as drifting are an indication of a proportional setting that is too low (which is addressed in the next step).

Gradually increase the proportional setting by doubling it each time. At each new setting, allow time for the temperature of the load to stabilize. As the proportional setting is increased, there should be a setting in which the load temperature begins a sustained and predictable oscillation rising and falling in a consistent period of time. See Figure 2-3(a). The goal is to find the proportional value in which the oscillation begins, do not turn the setting so high that temperature and heater output changes become violent.

Record the proportional setting and the amount of time it takes for the load change from one temperature peak to the next. The time is called the oscillation period of the load. It helps describe the dominant time constant of the load which is used in setting integral. If all has gone well, the appropriate proportional setting is *one half* of the value required for sustained oscillation. See Figure 2-3(b).

Tuning Proportional (Continued)

If the load does not oscillate in a controlled manner, the heater range could be set too low. A constant heater reading of 100% on the display would be an indication of a low range setting. The heater range could also be too high, indicated by rapid changes in the load temperature or heater output with a proportional setting of less than 5. There are a few systems that will stabilize and not oscillate with a very high proportional setting and a proper heater range setting. For these systems, setting a proportional setting of one half of the highest setting is the best choice.

2.7.3 Tuning Integral

When the proportional setting is chosen and the integral is set to zero (off), the Model 331 controls the load temperature below the setpoint. Setting the integral allows the Model 331 control algorithm to gradually eliminate the difference in temperature by integrating the error over time. See Figure 2-3(d). An integral setting that is too low causes the load to take too long to reach the setpoint. An integral setting that is too high creates instability and cause the load temperature to oscillate.

Begin this part of the tuning process with the system controlling in proportional only mode. Use the oscillation period of the load that was measured above in seconds. *Divide 1000 by the period to get the integral setting.* Enter the integral setting into the Model 331 and watch the load temperature approach the setpoint. If the temperature does not stabilize and begins to oscillate around the setpoint, the integral setting is too high and should be reduced by one half. If the temperature is stable but never reaches the setpoint, the integral setting is too low and should be doubled.

To verify the integral setting make a few small (2 to 5 degree) changes in setpoint and watch the load temperature react. Trial and error can help improve the integral setting by optimizing for experimental needs. Faster integrals, for example, get to the setpoint more quickly at the expense of greater overshoot. In most systems, setpoint changes that raise the temperature act differently than changes that lower the temperature.

If it was not possible to measure the oscillation period of the load during proportional setting, start with an integral setting of 20. If the load becomes unstable reduce the setting by half. If the load is stable make a series of small, two to five degree, changes in the setpoint and watch the load react. Continue to increase the integral setting until the desired response is achieved.

2.7.4 Tuning Derivative

If an experiment requires frequent changes in setpoint or data taking between changes in the setpoint, derivative should be considered. See Figure 2-3(e). A derivative setting of zero, off, is recommended when the control system is seldom changed and data is taken when the load is at steady state.

The derivative setting is entered into the Model 331 as a percentage of the integral time constant. The setting range is 0 – 200% where 100% = $\frac{1}{4}$ I seconds. Start with a setting of 50 to 100%.

Again, do not be afraid to make some small setpoint changes; halving or doubling this setting to watch the affect. Expect positive setpoint changes to react differently from negative setpoint changes.

2.8 AUTOTUNING

Choosing appropriate PID control settings can be tedious. Systems can take several minutes to complete a setpoint change, making it difficult to watch the display for oscillation periods and signs of instability. With the AutoTune feature, the Model 331 automates the tuning process by measuring system characteristics and, along with some assumptions about typical cryogenic systems, computes setting values for P, I, and D. AutoTune works only with one control loop at a time and does not set the manual heater power output or heater range. Setting an inappropriate heater range is potentially dangerous to some loads, so the Model 331 does not automate that step of the tuning process.

When the AutoTune mode is selected, the Model 331 evaluates the control loop similar to the manual tuning section described in Paragraph 2.7. One difference is that the Model 331 does not initiate changes to control settings or setpoint for the purpose of tuning. *It only gathers data and changes control settings after the user changes the setpoint.* Unexpected or unwanted disturbances to the control system can ruin experimental data being taken by the user.

AutoTuning (Continued)

When the user selects a new setpoint, the Model 331 logs the change in temperature at the load and the change in heater output that was required to make the load temperature change. The old control settings are used while data is being logged, so a good initial guess of settings can improve the efficiency of the AutoTune feature. Once the load temperature is at or near the new setpoint, the Model 331 looks at the logged data to calculate the best P, I, and D settings values. Those values are then loaded and used as the control parameters so the control loop can stabilize at the new setpoint. AutoTune does not function during a ramp because the dominant time constant of the load is disguised by the ramp rate.

The **Tune** LED blinks to indicate that tuning data is being logged. The LED is illuminated but not blinking when the tuning process is complete. The LED will not blink again until the user changes the setpoint. If AutoTune does not give desired results the first time, make a few small (2 to 5 degree) changes in setpoint and let the Model 331 go until the **Tune** LED stops blinking. In many cases, AutoTune is able to arrive at a better set of control settings.

There are situations where AutoTune is not the answer. The algorithm can be fooled when cooling systems are very fast, very slow, have a large thermal lag, or have a nonlinear relationship between heater power and load temperature. If a load can reach a new setpoint in under 10 seconds (with an appropriate I setting >500), the cooling system is too fast for AutoTuning. Systems with a very small thermal mass can be this fast. Adding mass is a solution, but is unappealing to users who need the speed for fast cycle times. Manual tuning is not difficult on these systems because new settings can be tested very quickly. Some systems are too slow for the AutoTune algorithm. Any system that takes more than 15 minutes to stabilize at a new setpoint is too slow (with an appropriate I setting <5).

Thermal lag can be improved by using the sensor and heater installation techniques discussed above. Lag times up to a few seconds should be expected, much larger lags can be a problem. System nonlinearity is a problem for both AutoTune and manual tuning. It is most commonly noticed when controlling near the maximum or minimum temperature of a temperature control system. It is not uncommon; however, for a user to buy a cryogenic cooling system specifically to operate near its minimum temperature. If this is the case, try to tune the system at 5 degrees above the minimum temperature and gradually reduce the setpoint, manually adjusting the control settings with each step. Any time the mechanical cooling action of a cryogenic refrigerator can be seen as periodic temperature fluctuations, the mass is too small or temperature too low to AutoTune.

2.9 ZONE TUNING

Once the PID tuning parameters have been chosen for a given setpoint the whole process may have to be done again for other setpoints significantly far away that have different tuning needs. Trying to remember when to use which set of tuning parameters can be frustrating. The Model 331 has a Zone feature as one of its tuning modes that can help.

To use the Zone feature the user must determine the best tuning parameters for each part of the temperature range of interest. The parameters are then entered into the Model 331 where up to ten zones can be defined with different P, I, D, heater range, and manual heater settings. A setpoint setting is assigned as the maximum temperature for that zone. The minimum temperature for a zone is the setpoint for the previous zone, 0 K is the starting point for the first zone. When Zone tuning is on, each time the setpoint changes, appropriate control parameters are chosen automatically.

Control parameters can be determined manually or by using the AutoTune feature. AutoTune is a good way to determine a set of tuning parameters for the control system that can then be entered as zones. Once the parameters are chosen, AutoTune is turned off and zone tuning takes over.

Zone tuning has advantages over AutoTune during normal operation. When a new setpoint is set the zone tuning automatically sets the appropriate control parameters for the destination. Approach to the new setpoint is controlled with the best parameters. AutoTune, on the other hand, is not able to learn enough about the system to change the control parameters until after the temperature gets near or to the new setpoint. Approach to the new setpoint is controlled with the old parameters because they are the best available.

CHAPTER 3

INSTALLATION

3.0 GENERAL

This chapter provides general installation instructions for the Model 331 Temperature Controller. Inspection and unpacking instructions are provided in Paragraph 3.1. Repackaging for shipment instructions are provided in Paragraph 3.2. An definition of rear panel controls is provided in Paragraph 3.3. The rear panel line input assembly is described in Paragraph 3.4. Standard sensor inputs are defined in Paragraph 3.5. Thermocouple sensor installation is described in Paragraph 3.6. Heater output setup is provided in Paragraph 3.7. The analog output and relays of the Model 331S are described in Paragraphs 3.8 and 3.9 respectively. An initial setup and system checkout procedure is provided in Paragraph 3.10. For computer interface installation, refer to Chapter 6.

3.1 INSPECTION AND UNPACKING

Inspect shipping containers for external damage. All claims for damage (apparent or concealed) or partial loss of shipment must be made in writing to Lake Shore within five (5) days from receipt of goods. If damage or loss is apparent, please notify the shipping agent immediately.

Open the shipping containers. A packing list is included with the system to simplify checking that the instrument, sensor(s), accessories, and manual were received. Please use the packing list and the spaces provided to check off each item as the instrument is unpacked. Inspect for damage. Be sure to inventory all components supplied before discarding any shipping materials. If there is damage to the instrument in transit, be sure to file proper claims promptly with the carrier and insurance company. Please advise Lake Shore Cryotronics of such filings. In case of parts or accessory shortages, advise Lake Shore immediately. Lake Shore cannot be responsible for any missing parts unless notified within 60 days of shipment. The standard Lake Shore Warranty is included on the A Page (immediately behind the title page) of this manual.

3.2 REPACKAGING FOR SHIPMENT

If it is necessary to return the Model 331, sensor(s), or accessories for recalibration, repair, or replacement, a Return Goods Authorization (RGA) number must be obtained from a factory representative before returning the instrument to our service department. When returning an instrument for service, the following information must be provided before Lake Shore can attempt any repair.

1. Instrument model and serial number.
2. User's name, company, address, and phone number.
3. Malfunction symptoms.
4. Description of system.
5. Returned Goods Authorization (RGA) number.

If possible, the original packing material should be retained for reshipment. If not available, consult Lake Shore for shipping and packing instructions.

3.3 REAR PANEL DEFINITION

This paragraph provides a description of the Model 331 rear panel connections. The rear panel consists of the line input assembly, RS-232 Connector, HEATER OUTPUT Connector, INPUT A and B Sensor Input Connectors, the RELAY and ANALOG OUTPUT Terminal Block, and the IEEE-488 INTERFACE Connector. Please read the entire chapter before performing the initial setup and system checkout procedure in Paragraph 3.10. Rear panel connector pin-out details are provided in Paragraph 8.4.

CAUTION: Verify AC Line Voltage shown in the fuse holder window is appropriate for the intended AC power input. Also remove and verify the proper fuse is installed before plugging in and turning on the instrument.

CAUTION: Always turn off the instrument before making any rear panel connections. This is especially critical when making sensor to instrument connections.

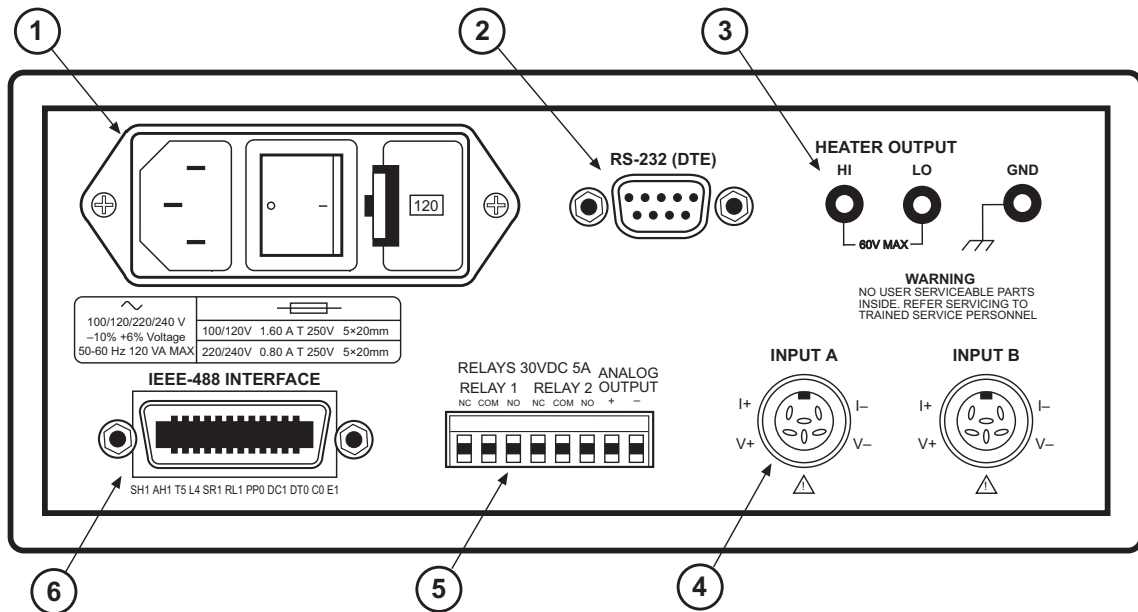

F-331-3-1.eps

	Description	Details
①	Line Input Assembly	Paragraph 3.4 Figure 8-1
②	RS-232 (DTE) 9 pin D-Style Connector	Paragraph 6.2.1 Figure 8-5
③	HEATER OUTPUT and Ground Banana Jacks	Paragraph 3.7 Figure 8-3
④	INPUT A and INPUT B Sensor (or Thermocouple) Input Connectors	Paragraphs 3.5 and 3.6 Figure 8-2
⑤	RELAYS and ANALOG OUTPUT Terminal Block (Model 331S Only)	Paragraphs 3.8 and 3.9 Figure 8-4
⑥	IEEE-488 INTERFACE Connector (Model 331S Only)	Paragraph 8.4.2 Figure 8-6

Figure 3-1. Model 331 Rear Panel

3.4 LINE INPUT ASSEMBLY

This section describes how to properly connect the Model 331 to line power. Please follow these instructions carefully to ensure proper operation of the instrument and the safety of operators.

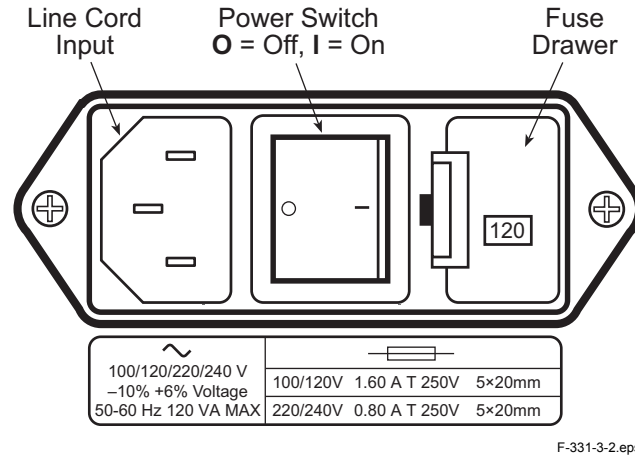

Figure 3-2. Line Input Assembly

3.4.1 Line Voltage

The Model 331 has four different AC line voltages configurations so that it can be operated from line power anywhere in the world. The nominal voltage and voltage range of each configuration is shown below. (The recommended setting for 230 V operation is 240 V.)

Nominal	Minimum	Maximum
100 V	90 V	106 V
120 V	108 V	127 V
220 V	198 V	233 V
240 V	216 V	254 V

Verify that the AC line voltage indicator in the fuse drawer window shows the appropriate AC line voltage before turning the instrument on. The instrument may be damaged if turned on with the wrong voltage selected. Instructions for changing the line voltage configuration are given in Paragraph 8.2.

3.4.2 Line Fuse and Fuse Holder

The line fuse is an important safety feature of the Model 331. If a fuse ever fails, it is important to replace it with the value and type indicated on the rear panel for the line voltage setting. The letter T on the fuse rating indicates that the instrument requires a time-delay or slow-blow fuse. Fuse values should be verified any time line voltage configuration is changed. Instructions for changing and verifying a line fuse are given in Paragraph 8.3.

3.4.3 Power Cord

The Model 331 includes a 3-conductor power cord that mates with the IEC 320-C14 line cord receptacle. Line voltage is present on the two outside conductors and the center conductor is a safety ground. The safety ground attaches to the instrument chassis and protects the user in case of a component failure. A CE approved power cord is included with instruments shipped to Europe; a domestic power cord is included with all other instruments (unless otherwise specified when ordered). Always plug the power cord into a properly grounded receptacle to ensure safe instrument operation.

The delicate nature of measurement being taken with this instrument may necessitate additional grounding including ground strapping of the instrument chassis. In these cases the operators safety should remain the highest priority and low impedance from the instrument chassis to safety ground should always be maintained.

3.4.4 Power Switch

The power switch is part of the line input assembly on the rear panel of the Model 331 and turns line power to the instrument On and Off. When the circle is depressed, power is Off. When the line is depressed, power is On.

3.5 DIODE/RESISTOR SENSOR INPUTS

This paragraph details how to connect diode and resistor sensors to the Model 331 inputs. Refer to Paragraph 4.4 to configure the inputs. The optional thermocouple input is described in Paragraph 3.6.

3.5.1 Sensor Input Connector and Pinout

The input connectors are 6-pin DIN 45322 sockets. The sensor output pins are defined in Figure 3-3. Two mating connectors (6-pin DIN plugs) are included in the connector kit shipped with the instrument. These are common connectors, so additional mating connectors can be purchased from local electronics suppliers. They can also be ordered from Lake Shore (P/N G-106-233).

NOTE: Pin 3 should not be used for new installations. However, to match existing Model 330 or Model 340 connector wiring, the definition of Pin 3 may be changed with a jumper. See Figure 8-7 for jumper location.

To provide compatibility with sensor input connectors that have been wired for either Lake Shore Model 330 or 340 Temperature Controllers, Jumper 4 (for Input A) and Jumper 7 (for Input B) are used to select the function of Pin 3 of the connectors. The Model 330 provides a constant 1 mA sensor excitation current on Pin 3 and 10 μ A current on Pin 5. The Model 340 provides both 1 mA and 10 μ A excitation current on Pin 5 and connects Pin 3 to sensor ground reference. If the sensor being used was wired for use with a Model 330, the jumper should be placed in the 330 position (factory default). This provides the output current selected via the front panel input setup function on both Pins 5 and 3. If the sensor was wired for use with a Model 340, the jumper should be placed in the 340 position. This provides the output current on Pin 5 only and connect Pin 3 to sensor ground reference.

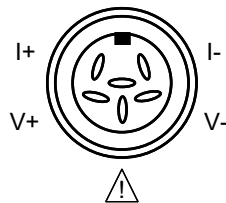

Pin	Symbol	Description
1	I-	- Current
2	V-	- Voltage
3	⚠	+1 mA – Model 330 Configuration Shield – Model 340 Configuration
4	V+	+ Voltage
5	I+	+ Current
6	None	Shield

Figure 3-3. Diode/Resistor Input Connector

3.5.2 Sensor Lead Cable

The sensor lead cable used outside the cooling system can be much different from what is used inside. Between the instrument and vacuum shroud, error and noise pick up need to be minimized, not heat leak. Larger conductor, 22 to 28 AWG stranded copper wire is recommended because it has low resistance yet remains flexible when several wires are bundled in a cable. The arrangement of wires in a cable is also important. For best results, voltage leads, V+ and V– should be twisted together and current leads I+ and I– should be twisted together. The twisted pairs of voltage and current leads should then be covered with a braided or foil shield which is connected to the shield pin of the instrument. This type of cable is available through local electronics suppliers. Instrument specifications are given assuming 10 feet of sensor cable. Longer cables, 100 feet or more, can be used but environmental conditions may degrade accuracy and noise specifications. Refer to Paragraph 2.3.6 for information about wiring inside the cryostat.

3.5.3 Grounding and Shielding Sensor Leads

The sensor inputs are isolated from earth ground to reduce the amount of earth ground referenced noise that is present on the measurement leads. This isolation can be defeated by connecting sensor leads to earth ground on the chassis of the instrument or in the cooling system. If one sensor lead must be grounded, ground only one lead and ground it in only one place. Grounding leads on more than one sensor prevents the sensor excitation current sources from operating.

Shielding the sensor lead cable is important to keep external noise from entering the measurement. A shield is most effective when it is near the measurement potential so the Model 331 offers a shield that stays close to the measurement. The shield of the sensor cable should be connected to the shield pin of the input connector. It should not be terminated at the opposite end of the cable. The shield should not be connected to earth ground on the instrument chassis or in the cooling system.

NOTE: The shell of the connector is in contact with the chassis so the cable shield should never touch the outer shell of the connector.

3.5.4 Sensor Polarity

Lake Shore sensors are shipped with instructions that indicate which sensor leads are which. It is important to follow these instructions for plus and minus leads (polarity) as well as voltage and current when applicable. Diode sensors do not operate in the wrong polarity. They look like an open circuit to the instrument. Two lead resistors can operate with any lead arrangement and the sensor instructions may not specify. Four-lead resistors can be more dependent on lead arrangement. Follow any specified lead assignment for four lead resistors. Mixing leads could give a reading that appears correct but is not the most accurate.

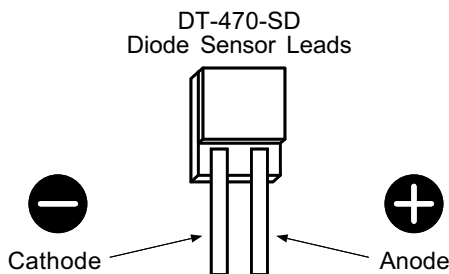

3.5.5 Four-Lead Sensor Measurement

All sensors, including both two lead and four lead can be measured with a four lead technique. The purpose of a four lead measurement is to eliminate the effect of lead resistance on the measurement. If it is not taken out, lead resistance is a direct error when measuring a sensor.

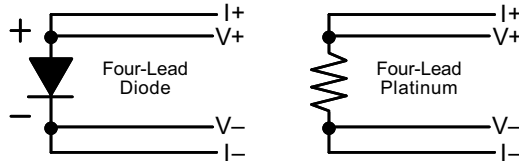

In a four lead measurement, current leads and voltage leads are run separately up to the sensor. With separate leads there is little current in the voltage leads so their resistance does not enter into the measurement. Resistance in the current leads will not change the measurement as long as the voltage compliance of the current source is not reached. When two lead sensors are used in four lead measurements, the short leads on the sensor have an insignificant resistance.

3.5.6 Two-Lead Sensor Measurement

There are times when crowding in a cryogenic system forces users to read sensors in a two lead configuration because there are not enough feedthroughs or room for lead wires. If this is the case, plus voltage to plus current and minus voltage to minus current leads are attached at the back of the instrument or at the vacuum feedthrough.

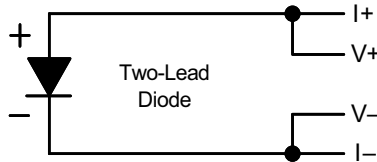

The error in a resistive measurement is the resistance of the lead wire run with current and voltage together. If the leads contribute 2 or 3 Ω to a 10 k Ω reading, the error can probably be tolerated. When measuring voltage for diode sensors the error in voltage can be calculated as the lead resistance times the current, typically 10 μA . For example: a 10 Ω lead resistance times 10 μA results in a 0.1 mV error in voltage. Given the sensitivity of a silicon diode at 4.2 K the error in temperature would be only 3 mK. At 77 K the sensitivity of a silicon diode is lower so the error would be close to 50 mK. Again, this may not be a problem for every user.

3.5.7 Lowering Measurement Noise

Good instrument hardware setup technique is one of the least expensive ways to reduce measurement noise. The suggestions fall into two categories: (1) Do not let noise from the outside enter into the measurement, and (2) Let the instrument isolation and other hardware features work to their best advantage. Here are some further suggestions:

- Use four-lead measurement whenever possible.
- Do not connect sensor leads to chassis or earth ground.
- If sensor leads must be grounded, ground leads on only one sensor.
- Use twisted shielded cable outside the cooling system.
- Attach the shield pin on the sensor connector to the cable shield.
- Do not attach the cable shield at the other end of the cable, not even to ground.
- Run different inputs and outputs in their own shielded cable.
- Use twisted wire inside the cooling system.
- Use similar technique for heater leads.
- Use a grounded receptacle for the instrument power cord.
- Consider ground strapping the instrument chassis to other instruments or computers.

3.6 THERMOCOUPLE SENSOR INPUTS (Model 331X-TX Only)

The information in this paragraph is for a Model 331 configured at the factory with one or two thermocouple sensor inputs; being Model 331X-T1 or T2. Sensor connection is important when using thermocouples because the measured signal is small. Many measurement errors can be avoided with proper sensor installation.

CAUTION: Do not leave thermocouple inputs unconnected. Short inputs when not in use.

3.6.1 Sensor Input Terminals

Attach sensor leads to the screws on the off-white ceramic terminal blocks. Each block has two screw terminals; one positive (on the I+/V+ side of the connector), one negative (on the I-/V- side of the connector). See Figure 3-4.

The current and voltage references silkscreened on the back panel are for the diode/resistor connectors. For thermocouples, the positive (+) wire goes to the left-side terminal and the negative (-) wire to the right-side terminal. Remove all insulation then tighten the screws on the thermocouple wires. Keep the ceramic terminal blocks away from heat sources including sunlight and shield them from fans or room drafts.

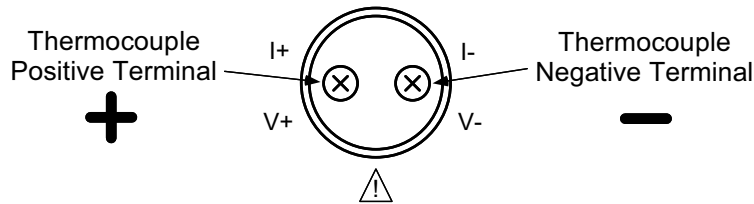

Common Thermocouple Polarities	Positive (+)	Negative (-)
Type K (Nickel-Chromium vs. Nickel-Aluminum)	Chromel (YEL)	Alumel (RED)
Type E (Nickel-Chromium vs. Copper-Nickel)	Chromel (PUR)	Constantan (RED)
Type T (Copper vs. Copper-Nickel)	Copper (BLU)	Constantan (RED)
Chromel-AuFe 0.03%	Chromel	Gold
Chromel-AuFe 0.07%	Chromel	Gold

Figure 3-4. Thermocouple Input Definition and Common Connector Polarities

3.6.2 Thermocouple Installation

Thermocouples are commonly used in high-temperature applications. Cryogenic use of thermocouples offers some unique challenges. A general installation guideline is provided in Paragraph 2.3. Consider the following when using thermocouples at low temperatures:

- Thermocouple wire is generally more thermally conductive than other sensor lead wire. Smaller gauge wire and more heat sinking may be needed to prevent leads from heating the sample.
- Attaching lead wires and passing through vacuum tight connectors are often necessary in cryogenic systems. Remember, the thermocouple wire *is* the sensor; any time it joins or contacts other metal, there is potential for error.
- Temperature verification and calibration of room temperature compensation is difficult after the sensor is installed. When possible, keep a piece of scrap wire from each installation for future use.

3.6.3 Grounding and Shielding

For lowest measurement noise, do not ground thermocouple sensors. The instrument usually operates with more noise if one of the thermocouples is grounded. Grounding both thermocouples is not recommended. The instrument does not offer a shield connection on the terminal block. Twisting the thermocouple wires helps reject noise. If shielding is necessary, extend the shield from the oven or cryostat to cover the thermocouple wire, but do not attach the shield to the instrument.

3.7 HEATER OUTPUT SETUP

The following paragraphs cover the heater wiring from the vacuum shroud to the instrument for both control loop outputs. Specifications are detailed in Paragraph 1.2. For help on choosing and installing an appropriate resistive heater, refer to Paragraph 2.4.

3.7.1 Loop 1 Output

Of the two Model 331 control loops, Loop 1 is considered the primary loop because it is capable of driving 50 W of heater power. The heater output for Loop 1 is a traditional control output for a cryogenic temperature controller. It is a variable DC current source with software settable ranges and limits. The maximum heater output current is 1 A and maximum compliance voltage is 50 V. Heater power is applied in one of three ranges: Low, Medium, or High, as specified below.

Loop 1 Full Scale Heater Power at Typical Resistance

Heater Resistance	Heater Range	Heater Power
10 Ω	Low	100 mW
	Med	1 W
	High	10 W
25 Ω	Low	250 mW
	Med	2.5 W
	High	25 W
50 Ω	Low	500 mW
	Med	5 W
	High	50 W

3.7.2 Loop 1 Heater Output Connector

A dual banana jack on the rear panel of the instrument is used for connecting wires to the Loop 1 heater. A standard dual banana plug mating connector is included in the connector kit shipped with the instrument. This is a common jack and additional mating connectors can be purchased from local electronic suppliers, or from Lake Shore (P/N 106-009). The heater is connected between the HI and LO terminals. The ground terminal is reserved for shielding the heater leads when necessary.

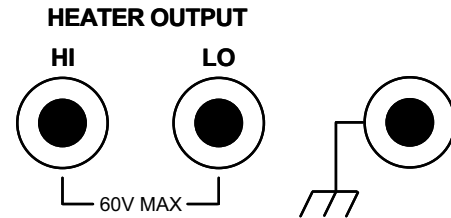

3.7.3 Loop 1 Heater Output Wiring

Heater output current is what determines the size (gauge) of wire needed to connect the heater. The maximum current that can be sourced from the Loop 1 heater output is 1 A. When less current is needed to power a cooling system it can be limited with range settings.

When setting up a temperature control system, the lead wire for the heater be capable of carrying a continuous current that is greater than the maximum current. Wire manufactures recommend 30 AWG or larger wire to carry 1 A of current, but there is little advantage in using wire smaller than 20 to 22 AWG outside the cryostat. Inside the cryostat, smaller gauge wire is often desirable.

It is recommended to use twisted heater leads. Large changes in heater current can induce noise in measurement leads and twisting reduces the effect. It is also recommended to run heater leads in a separate cable from the measurement leads to further reduce interaction.

There is a chassis ground point at the rear panel of the instrument for shielding the heater cable. The cable shield can be tied to this point with a single banana plug. The shield should not be connected at the opposite end of the cable and should never be tied to the heater output leads.

The Loop 1 heater output is isolated from chassis ground to reduce noise. For best noise performance, do not connect the resistive heater or its leads to ground. Also avoid connecting heater leads to sensor leads or any other instrument inputs or outputs.

3.7.4 Loop 1 Heater Output Noise

The heater output circuitry in the Model 331 must be capable of sourcing 50 W of power. This type of circuitry can generate some electrical noise. The Model 331 was designed to generate as little noise as possible but even noise that is a small percentage of the output voltage or current can be too much when sensitive measurements are being made near by. If the Model 331 heater leads are too noisy and the above wiring techniques do not help, Lake Shore offers the Model 3003 Heater Output Conditioner that may help. Refer to Paragraph 7.4.

3.7.5 Loop 2 Output

The Model 331 has a second control loop called Loop 2. Loop 2 is an auxiliary control loop with enough features to control a radiation shield or small sample heater. Loop 2 has a different output from Loop 1, it uses Analog Voltage output as its actuator. It is a variable DC voltage source that can vary from 0 V to +10 V. The output can source up to 100 mA of current providing a maximum of 1 W of heater power.

3.7.6 Loop 2 Output Resistance

The power delivered by the Loop 2 output is calculated as: $P = \frac{V^2}{R_{heater}}$

The output is rated for no more than 100 mA of current. For the maximum of 1 W output power use a 100 Ω resistive heater with a power rating greater than 1 W. Smaller resistance values should not be used, but larger resistances can be used for lower power applications.

3.7.7 Loop 2 Output Connector

The connector for the Loop 2 output is on the RELAYS and ANALOG OUTPUT Terminal Block. See Pins 7 and 8 in Figure 3-5. Twisted pair of small gauge wire is recommended.

3.7.8 Loop 2 Heater Protection

The output is short protected so the instrument is not harmed if the heater resistance is too small. It is not recommended because the additional load on instrument power supplies causes noise on internal circuits. The second control loop has fewer features than the first including software protection and limits. The user must be careful to build a robust system and account for the voltage range and power up state of the control output.

3.7.9 Boosting Output Power

There are temperature control systems that require more power than the Model 331 can provide. An auxiliary DC power supply can be used to boost the output of the Model 331. Programmable power supplies are available that use a low current programming voltage as an input to control a high current voltage output. Analog Voltage Output, used for Loop 2 output, provides an ideal programming voltage for an auxiliary power supply.

The only drawback with using the analog output to program auxiliary supplies is it only has one voltage range. The heater output for Loop 1 has several ranges that can improve resolution, but its output is in current not voltage. To use Loop 1 to program a larger power supply, a programming resistor can be placed across the heater output to produce a programming voltage. The programming voltage is related to output current by:

$$V_{program} = R_{program} \times I_{output}$$

The resistor must be chosen to convert a full scale current from the highest heater output range being used to the full scale programming voltage of the auxiliary supply. For example, if the auxiliary supply has a full scale programming voltage of 10 V and the maximum current for the highest heater output range being used is 0.3 A the programming resistor should be 10 V / 0.3 A = 33 Ω. The programming resistor must be rated for the power being dissipated in it which is:

$$Power = I_{output}^2 \times R_{program}$$

or 3 W. The “Low” heater output range can be selected to reduce the power dissipated in the programming resistor.

3.8 ANALOG OUTPUT (Model 331S Only)

The Analog Output available on the rear panel of the Model 331S is a voltage output that can be used for monitor and control applications. Their most basic function is a temperature monitor where it puts out a voltage that is proportional to temperature. It can be configured to monitor the output of a linear equation which allows the user to select an offset and gain. The analog output can be controlled manually by the user for any application that requires a programmable voltage source or as mentioned above as Control Loop 2. Refer to Paragraph 4.16 and the ANALOG command in Chapter 6.

The analog output is a variable DC voltage source that can vary from -10 V to $+10\text{ V}$. The resolution of the analog output is 0.3 mV or 0.003% of full scale. The output can source up to 100 mA of current providing a maximum of 1 W of power. It can drive a resistive load of no less than $100\ \Omega$. The output is short protected so the instrument is not harmed if the heater resistance is too small. It is not recommended because the additional load on instrument power supplies causes noise on internal circuits.

The output for the analog outputs is available from positions 7 and 8 of the detachable RELAY and ANALOG OUTPUT Terminal Block. See Figure 3-5. The terminal marked positive (+) is the output voltage terminal, the terminal marked negative (-) is the ground and is attached to chassis ground inside the instrument.

It is not recommended to attach the analog output ground to a ground outside the instrument. The output should be read by an instrument with an isolated or differential input wherever possible. Connecting to an external ground can cause noise in the analog output voltage or the sensor input measurement. If this cannot be avoided, try to keep the chassis of the two instruments at the same potential with a ground strap.

3.9 RELAYS (Model 331S Only)

The Model 331S has one high and one low relay. They are most commonly associated with the alarm feature. The relays can also be placed in manual mode and controlled directly by the user from the front panel or over the computer interface. Refer to Paragraph 4.15 and the RELAY command in Chapter 6.

Normally Open (N.O.), Normally Closed (N.C.), and Common (COM) contacts are available for each relay. All contacts (including common) are isolated from the measurement and chassis grounds of the instrument. If a relay is inactive (Off), it will be in its normal state of open or closed. When the relay is active (On), it will be in the opposite state.

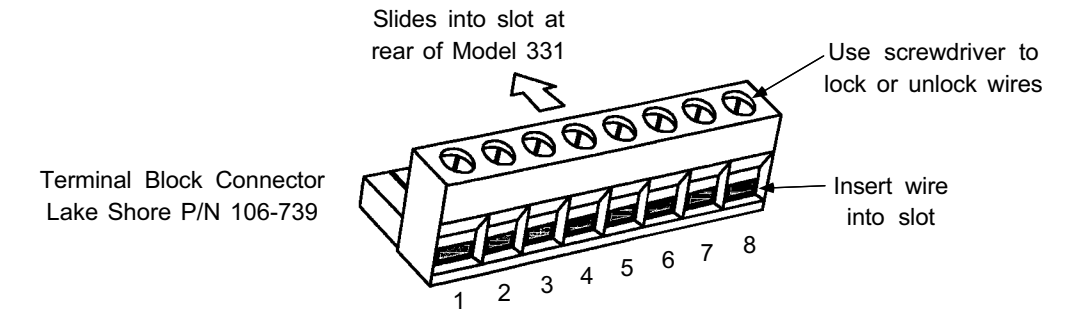

Pin	Description	Pin	Description
1	Relay 1 – Normally Closed (NC)	5	Relay 2 – Common (COM)
2	Relay 1 – Common (COM)	6	Relay 2 – Normally Open (NO)
3	Relay 1 – Normally Open (NO)	7	Loop2/Analog Voltage Output – Hi (+)
4	Relay 2 – Normally Closed (NC)	8	Loop2/Analog Voltage Output – Lo (-)

Figure 3-5. RELAYS and ANALOG OUTPUT Terminal Block

Relays (Continued)

Relay connections are available in positions 1 thru 6 of the detachable RELAY and ANALOG OUTPUT Terminal Block. See Figure 3-5. The terminal block (P/N 106-737) is included with the Model 331. For convenient installation of wires, the terminal block may be removed from the socket. According to the manufacturer, up to 12 AWG stranded copper wire may be used with the terminal block, though it is unlikely that wire that large is required to carry the rated 5 amp current of the relay.

3.10 INITIAL SETUP AND SYSTEM CHECKOUT PROCEDURE

The following is an initial instrument setup and checkout procedure. The intent is to verify basic operation of the unit before beginning use for measurements. The procedure assumes a setup with two Lake Shore DT-470 Silicon Diode Sensors, one control loop, a single 50 Ω heater, all readings in Kelvin, and running in a liquid nitrogen environment.

CAUTION: Check power source for proper voltage before connecting the line cord to the Model 331. Also check the line voltage setting on the window in the fuse drawer. Damage to unit may occur if connected to improper voltage.

1. Check power source for proper voltage. The Model 331 operates with 100, 120, 220, or 240 (+6%, -10%) AC input voltage.
2. Check window in fuse drawer for proper voltage setting. If incorrect, refer to Paragraph 8.2.
3. Ensure the power switch is in the off (O) position.

CAUTION: The sensor must be connected to the rear of the unit before applying power to the Temperature Controller. Damage to the sensor may occur if connected with power on.

4. Verify your sensor installation in the liquid nitrogen environment. Then plug the control sensor connector in INPUT A and the sample sensor connector in INPUT B. Details of sensor hardware connections are detailed in Paragraph 3.5.
5. Connect the heater to the banana jacks labeled HEATER OUTPUT. A 50 Ω heater allows the maximum power output of 50 W. Details of heater installation are provided in Paragraphs 2.4 and 3.7.
6. Ensure any other rear panel connections are connected before applying power to the unit. For the Model 331E, this includes RS-232 (Paragraph 6.2.1). For the Model 331S, this includes the IEEE-488 (Paragraph 8.4.2), Analog Output (Paragraph 3.8), and Relays (Paragraph 3.9).
7. Plug line cord into receptacle.
8. Turn the power switch to the on (I) position. The front panel will briefly display the following.

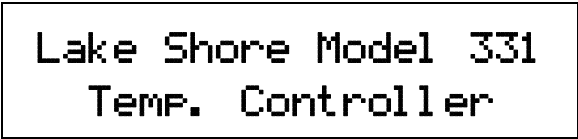

9. The typical display shown below will now appear.

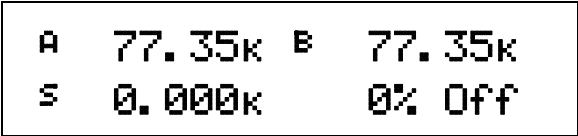

The front panel display is divided into four areas. The default display settings place the Sensor A reading in the upper left, the Sensor B reading in the upper right, the Setpoint in the lower left, and the heater output of Loop 1 (in percent) in the lower right. All temperature readings are in Kelvin. Each of these display areas is individually configurable by pressing the **Display Format** key and following the instructions in Paragraph 4.3.

Initial Setup and System Checkout Procedure (Continued)

NOTE: For rated accuracy, the instrument should warm up for at least 30 minutes.

10. The default input settings are “Silicon Diode” on Inputs A and B, with Input A controlling using the “Curve 01 DT-470.” These settings can be verified by pressing the **Input Setup** key and following the instructions in Paragraph 4.4.
11. The default control mode is “Manual PID” where the Proportional, Integral, and Derivative (PID) settings are entered by the user. The default settings are P = 50, I = 20, and D = 0. These settings can be verified and/or adjusted by pressing the **PID/MHP** key and following the instructions in Paragraph 4.8.
12. For an experiment running at liquid nitrogen temperature, a setpoint of 77 K is good for testing purposes. Press the **Setpoint** key. Press the “7” key twice, then press the **Enter** key. Details of setpoint setting are discussed in Paragraph 4.11.

A	77.35k	B	75.35k
S	77.000k		0% Off

13. The default setting for the heater is “Off.” To turn the heater on, press the **Heater Range** key. Press the **▲** or **▼** key until “Low” is displayed. Press the **Enter** key. Depending on your actual setup, you may need to apply more current to the heater, which is accomplished by selecting either the “Med” or “High” range. Details of heater settings are discussed in Paragraph 4.13.

A	77.05k	B	75.10k
S	77.000k		50% Low

NOTE: If any problems appear, immediately press the **Heater Off** key. If any error messages are displayed, refer to Paragraph 8.8 for details.

The Model 331 should now be controlling the temperature in the experimental setup at the setpoint temperature. Once this initial checkout procedure is successfully completed, the unit is ready for normal operation. We recommend all users thoroughly read Chapter 4 – Operation before attempting to use the Model 331 in an actual experiment or application.

CHAPTER 4

OPERATION

4.0 GENERAL

This chapter describes Model 331 Temperature Controller operation. A definition of front panel controls is provided in Paragraph 4.1. Turning power on is described in Paragraph 4.2. Paragraphs 4.3 thru 4.20 describe operation of instrument features. Instrument default settings are provided in Paragraph 4.21. Advanced operation is described in Chapter 5. Computer interface operation is detailed in Chapter 6.

4.1 FRONT PANEL DESCRIPTION

This paragraph provides a description of the front panel controls and indicators for the Model 331.

4.1.1 Keypad Definitions

An abbreviated description of each key is provided as follows. A more detailed description of each function is provided in subsequent paragraphs. See Figure 4-1.

- AutoTune** Allows selection of closed loop tuning mode: AutoTune PID, PI, P, Manual PID, or Zone for the currently selected loop. Refer to Paragraph 4.9.
- Loop** Toggles the front panel display and key functions between Loop 1 and 2. Operates with: Control Setup, Setpoint, PID/MHP, Zone Settings, AutoTune, Heater Range, and Heater Off. Refer to Paragraph 4.6.1.
- Heater Range** For Loop 1, allows selection of High (50 W), Medium (5 W), or Low (0.5 W) heater range. For Loop 2, allows selection of Heater On/Off. Refer to Paragraph 4.13.
- Heater Off** Turns the heater off for Loop 1 or turns the control output off for Loop 2. Refer to Paragraph 4.13.

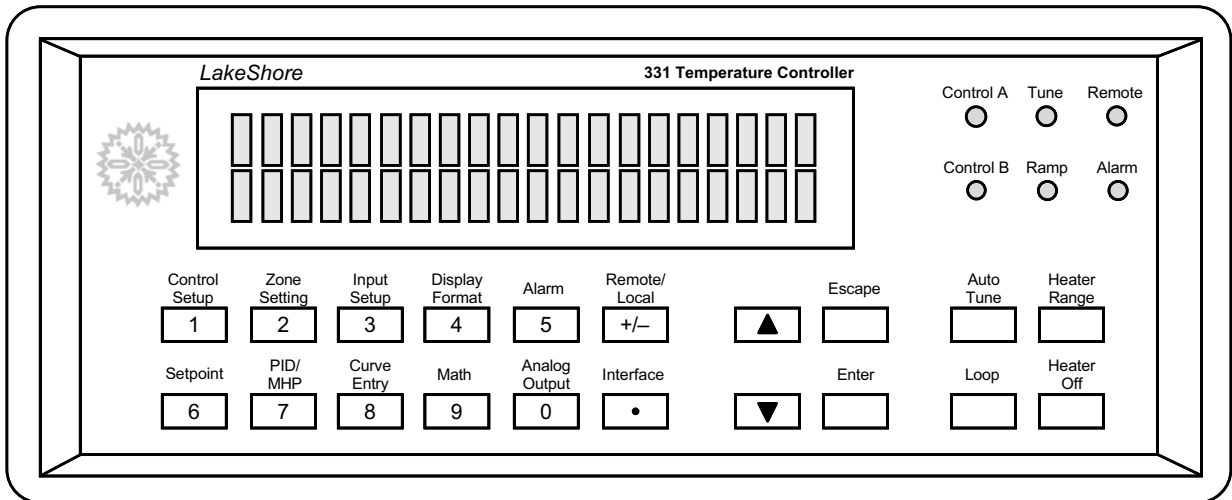

C331-1-1.eps

Figure 4-1. Model 331 Front Panel

Keypad Definitions (Continued)

Control Setup	Allows selection of control input, setpoint units, closed or open loop control mode, power up enable, display of heater output units, setpoint ramp enable, and ramp rate for the currently selected loop. Refer to Paragraph 4.7 for control setup and Paragraph 4.12 for ramp feature.
Setpoint	Allows entry of control setpoint for the currently selected loop. Refer to Paragraph 4.11. A discussion of the ramp feature is provided in Paragraph 4.12.
Zone Settings	Allows entry of up to 10 temperature control zones of customer-entered PID settings and Heater Ranges for the currently selected loop. Refer to Paragraph 4.10.
PID/MHP	Allows manual adjustment of control parameters Proportional, Integral, and Derivative, or Manual Heater Power (MHP) output for the currently selected loop. Refer to Paragraph 4.8.
Input Setup	Allows selection of sensor input type and curve. Refer to Paragraph 4.4 for sensor input setup and Paragraph 4.5 for curve selection.
Curve Entry	Allows entry of up to twenty 200-point CalCurves or user curves and SoftCal. Refer to Chapter 5 – Advanced Operation, Paragraph 5.2 Front Panel Curve Entry Operations.
Display Format	Allows the user to configure the display and select the units or other source of the readings. Refer to Paragraphs 4.1.4 and 4.3. Press and hold to set display brightness. Refer to Paragraph 4.18.
Math	Allows the user to configure the math features: Max/Min, linear equation, and filter. Press twice to reset the stored Max/Min readings. Refer to Paragraph 4.14.
Alarm	Allows the user to configure both the alarms and relays (331S Only). Refer to Paragraph 4.15.
Analog Output	Allows the user to configure the analog output feature. Also used to assign the analog output to Loop 2 control output thus enabling Loop 2 (331S Only). Refer to Paragraph 4.16.
Remote/Local	Sets remote or local operation: Remote refers to operation is via IEEE-488 Interface (Model 331S only); Local refers to operation via the front panel. Refer to Paragraph 4.19.
Interface	Sets the Baud rate of the serial interface and IEEE-488 address and terminators (331S Only). Refer to Paragraph 4.20.
▲	Serves two functions: chooses between parameters during setting operations and to increment a numerical parameter values.
▼	Serves two functions: chooses between parameters during setting operations and decrements numerical parameter values.
Escape	Terminates a setting function without changing the existing parameter value. Press and hold to reset instrument to default values. Refer to Paragraph 4.21.
Enter	Completes setting functions and returns to normal operation. Press and hold to lock or unlock keypad. Refer to Paragraph 4.17.
0–9, +/-, .	Used for entry of numeric data. Includes a key to toggle plus (+) or minus (–), and a key for entry of a decimal point. Refer to Paragraph 4.1.3.

4.1.2 Annunciators

LED Annunciators

Six blue LED annunciators are included to provide visual feedback of the following operation.

- Control A** On when Input A is being used as the control input for the loop being displayed. Refer to Paragraph 4.4.
- Control B** On when Input B is being used as the control input for the loop being displayed. Refer to Paragraph 4.4.
- Tune** On steady when the AutoTune feature is on, blinking when AutoTune is actively gathering data. Refer to Paragraph 4.9.
- Ramp** On steady when the Ramp feature is on, blinking during a setpoint ramp. Refer to Paragraph 4.12 for turning ramping on and setting the ramp rate.
- Remote** On when the instrument is in Remote mode, i.e., may be controlled via the IEEE-488 Interface. Refer to Paragraphs 4.19 and 4.20.
- Alarm** On steady when the alarm feature is on, blinking when any alarm is active. Refer to Paragraph 4.15.

Display Annunciators

A	Sensor Input A	Ω	Sensor Units of Ohms
B	Sensor Input B	mV	Sensor Units of Millivolts
S	Setpoint	>	Maximum Reading Value
K	Temperature in Kelvin	<	Minimum Reading Value
C	Temperature in Celsius	/	Result of Linear Equation
V	Sensor Units of Volts		

4.1.3 General Keypad Operation

There are three basic keypad operations: Direct Operation, Setting Selection, and Data Entry.

Direct Operation. The key function occurs as soon as the key is pressed, e.g., Loop, Heater Off, and Remote/Local.

Setting Selection. Allows the user to select from a list of values. During a selection sequence the **▲** or **▼** key are used to select a parameter value. After a selection is made the **Enter** key is pressed to make the change and advance to the next setting, or the **Escape** key is pressed to return to the normal display without changing the present setting. The instrument retains any values entered prior to pressing the **Escape** key. Some selections are made immediately after pressing a function key; like Heater Range. Most are part of a string of settings. Setting selections always include the "Select for ... **▲▼**" display, a sample of which is shown below.



Data Entry. Allows the user to enter number data using the data entry keys. Data entry keys include the numbers 0–9, +/-, and decimal point. Proportional control parameter is an example of a parameter that requires data entry. During a data entry sequence use the data entry keys to enter the number value, press the **Enter** key to accept the new data and advance to the next setting. Press the **Escape** key once to clear the entry, twice to return to the normal display. Most data entry operations are combined with other settings and grouped under a function key. Temperature or sensor unit parameters have the same setting resolution as the display resolution for their corresponding readings. Data entry always includes the "Enter for ..." display, a sample of which is shown below.



4.1.4 Display Definition

In normal operation, the 2 row by 20 character vacuum fluorescent display is divided into four user-configurable areas that can provide temperature readings, setpoint display, and heater status. Other information is displayed when using the various functions on the keypad. See Figure 4-2.

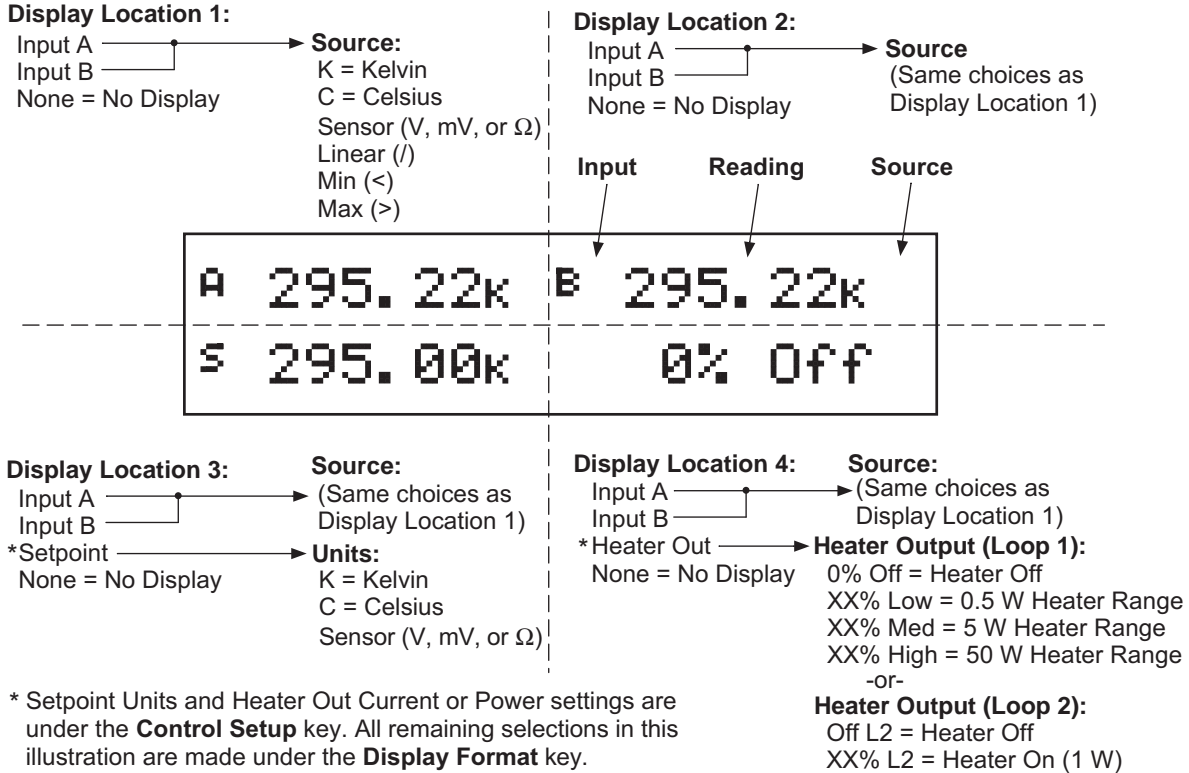

C331-4-2.eps

Figure 4-2. Display Definition

4.2 TURNING POWER ON

After verifying line voltage (Paragraph 3.4), plug the instrument end of the line cord (included with the connector kit) into the power and fuse assembly receptacle on the instrument rear. Plug the opposite end of the line cord into a properly grounded, three-prong receptacle. Place the power switch, located next to the line cord receptacle, to the On (I) position. The instrument initiates the following power up sequence: the instrument alarm sounds once; the display shows the following startup message.

Lake Shore Model 331
Temp. Controller

The normal reading display appears. If the instrument does not complete the sequence or if a general error message displays, there may be a problem with the line power or the instrument. Individual messages in a reading location normally indicate that input setup is required.

4.3 DISPLAY FORMAT AND SOURCE (UNITS) SELECTION

In the normal display, the display is divided into four user-configurable areas that can provide temperature readings, setpoint display, and heater status. Figure 4-3 illustrates the display location numbering and available selections for each location. To change Setpoint units and select Heater Out Power or Current, refer to the description of **Control Setup** in Paragraph 4.7. To change display brightness, refer to Paragraph 4.18.

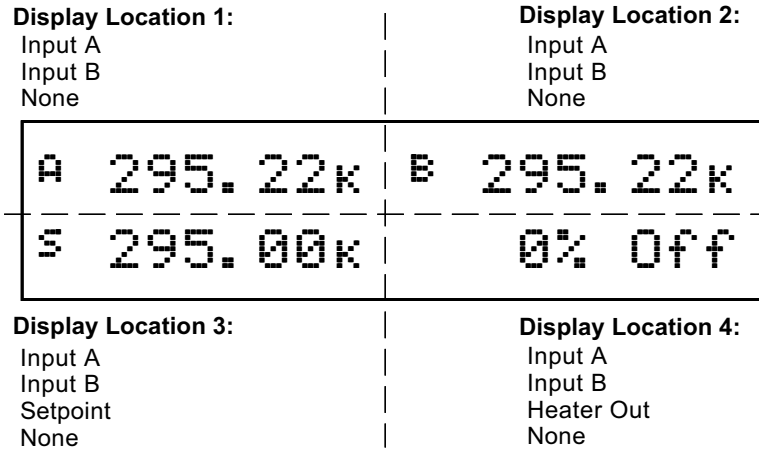

C-331-4-3.eps

Figure 4-3. Display Format Definition

To configure a display location, press the **Display Format** key to display the following screen.

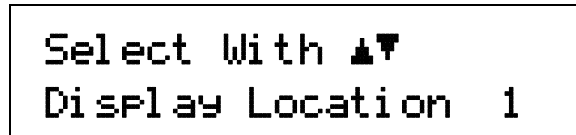

Use the ▲ or ▼ key to increment or decrement through Display Locations 1 thru 4. For this example, select Display Location 1, then press the **Enter** key. You will see the following display

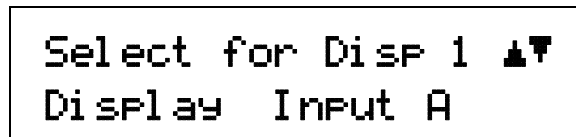

Use the ▲ or ▼ key to cycle between Input A, Input B, or None. For this example, select Input A then press the **Enter** key. You will see the following display



Use the ▲ or ▼ key to cycle through the following data sources: Temp K, Temp C, Sensor, Linear, Min, and Max. For this example, select Temp K then press the **Enter** key.

NOTE: The sensor reading of the instrument can always be displayed in sensor units. If a temperature response curve is selected for an input, its readings may also be displayed in temperature.

Display Format (Continued)

With the settings from the previous example, Display Location 1 will resemble the following.

```
A 295.22k
```

The process is the same for the other three display locations. However, additional choices are provided for Display Location 3 and 4, being Setpoint and Heater Out respectively.

In the following example, we will setup Display Location 3 to show the setpoint. Press the **Display Format** key.

```
Select With ▲▼
Display Location 3
```

Use the ▲ or ▼ key to increment or decrement through Display Locations 1 thru 4. For this example, select Display Location 3, then press the **Enter** key. You will see the following display

```
Select for Disp 3 ▲▼
Display Setpoint
```

Use the ▲ or ▼ key to cycle between Input A, Input B, Setpoint, or None. For this example, select Setpoint then press the **Enter** key.

With the settings from the previous example, and assuming you setup Display Location 1 detailed above, the display will resemble the following.

```
A 295.22k B 295.22k
S 0.000k
```

To change the setpoint units, refer to Control Setup, Paragraph 4.7.

4.4 INPUT SETUP

The Model 331 supports a variety of temperature sensors sold by Lake Shore and other manufacturers. An appropriate sensor type must be selected for each of the two inputs. If the exact sensor model is not shown, use the sensor input performance chart in Table 4-1 to choose an input type with similar range and excitation. For additional details on sensors, refer to the Lake Shore Temperature Measurement and Control Catalog or visit our website at www.lakeshore.com.

Table 4-1. Sensor Input Types

Display Message	Input Range	Excitation	Sensor Type	Curve Format	Coefficient	Lake Shore Sensors *
Silicon Diode	2.5 V	10 μ A	Silicon Diode	V/K	Negative	DT-4XX, DT-500, DT-670 Series
GaAlAs Diode	7.5 V	10 μ A	Gallium-Aluminum-Arsenide Diode	V/K	Negative	TG-120 Series
2.5V, 1mA	2.5 V	1 mA	Diode	V/K	Negative	—
7.5V, 1mA	7.5 V	1 mA	Diode	V/K	Negative	—
100 Ω Plat/250	250 Ω	1 mA	100 Ω Plat. RTD <675K; Rhodium-Iron RTD	Ω /K	Positive	PT-100 Series Platinum, RF-800 Rhodium-Iron
100 Ω Plat/500	500 Ω	1 mA	100 Ω Plat. RTD >675K			
1000 Ω Plat	5000 Ω	1 mA	1000 Ω Plat. RTD	Ω /K	Positive	—
NTC RTD	7500 Ω	10 μ A	Negative Temperature Coefficient (NTC) RTD	log R/K	Negative	Cernox™, High-Temperature Cernox™, Carbon Glass™, Germanium, Rox™, and Thermox
Thermo/25mV	\pm 25 mV	NA	Thermocouple	mV/K	Positive	Chromel-AuFe (0.07%), Type E (Chromel-Constantan), Type K (Chromel-Alumel), Type T (Copper-Constantan),
Thermo/50mV	\pm 50 mV	NA	Thermocouple			

* Refer to the Lake Shore Temperature Measurement and Control Catalog for complete details on all Lake Shore Temperature Sensors.

4.4.1 Diode Sensor Input Setup – 10 μ A Excitation Current

Diode sensors include the Silicon and Gallium-Aluminum-Arsenide (GaAlAs) detailed in Table 4-1. More detailed specifications are provided in Table 1-3. Input ranges for are fixed to 0–2.5 V for silicon diodes and 0–7.5 V for GaAlAs diodes. Both use a sensor excitation current of 10 μ A.

To setup a diode sensor input, press the **Input Setup** key. The first screen appear as follows.

```
Select With ▲▼
Input Setup Input A
```

Use the **▲** or **▼** key to toggle between Input A and B. Press the **Enter** key.

```
Select for InputA ▲▼
Type Silicon Diode
```

Use the **▲** or **▼** key to cycle through the sensor types shown in Table 4-1, with “Silicon Diode” and “GaAlAs Diode” being the relevant choices. Press the **Enter** key. Proceed to Paragraph 4.5.1 to select a temperature curve or press the **Escape** key to return to the normal display.

4.4.2 Diode Sensor Input Setup – 1 mA Excitation Current

As an alternative to the standard diode input configuration listed above, the user may select 1 mA excitation while the input configuration matches the diode input setup as detailed in Table 4-1. Input ranges are fixed to 0–2.5 V and 0–7.5 V.

To access the alternative setup, the diode current must be set to 1 mA. Press and hold the **Input Setup** key for 10 seconds to display the screen shown as follows:

```

Select for InputA ▲▼
Diode Current 1mA
    
```

Use the ▲ or ▼ key to toggle between 10 µA and 1 mA to select the diode current for Input A. 1 mA must be selected for the special sensor input to be available for Input A. Press the **Enter** key.

```

Select for InputB ▲▼
Diode Current 1mA
    
```

Use the ▲ or ▼ key to toggle between 10 µA and 1 mA to select the diode current for Input B. 1 mA must be selected for the special sensor input to be available for Input B. Press the **Enter** key.

To setup the diode input using 1 mA excitation, press the **Input Setup** key. The first screen appears as follows.

```

Select With ▲▼
Input Setup Input A
    
```

Use the ▲ or ▼ key to toggle between Input A and B. Press the **Enter** key.

```

Select for InputA ▲▼
Type 2.5V, 1mA
    
```

Use the ▲ or ▼ key to cycle through the sensor types shown in Table 4-1, with “2.5V, 1mA” and “7.5V, 1mA” being the relevant choices. Press the **Enter** key. Proceed to Paragraph 4.5.1 to select a temperature curve or press the **Escape** key to return to the normal display.

4.4.3 Resistor Sensor Input Setup

Resistor sensors include the Platinum, Rhodium-Iron, and various NTC RTD sensors (e.g., Cernox™, Rox™, Thermox) detailed in Table 4-1. More detailed specifications are provided in Table 1-3. Input range is fixed to type of sensor. The excitation current applied by the Model 331 is determined by the user selection of Negative Temperature Coefficient (NTC) = 10 µA or Positive Temperature Coefficient (PTC) = 1 mA.

To setup a resistor sensor input, press the **Input Setup** key. The first screen appear as follows.

```
Select With ▲▼
Input Setup Input A
```

Use the ▲ or ▼ key to toggle between Input A and B. Press the **Enter** key.

```
Select for InputA ▲▼
Type NTC RTD
```

Use the ▲ or ▼ key to cycle through the sensor types shown in Table 4-1, with “100Ω Plat/250,” “100Ω Plat/500,” “1000Ω Plat,” and “NTC RTD” being the relevant choices. Press the **Enter** key.

4.4.3.1 Thermal EMF Compensation

To keep power low and avoid sensor self heating, the sensor excitation is kept low. There are two major problems that occur when measuring the resulting small DC voltages. The first is external noise entering the measurement through the sensor leads which is discussed with sensor setup. The second problem is the presence of thermal EMF voltages, sometimes called thermocouple voltages, in the lead wiring. Thermal EMF voltages appear whenever there is a temperature gradient across a piece of voltage lead. Thermal EMF voltages must exist because the sensor is almost never the same temperature as the instrument. They can be minimized by careful wiring, making sure the voltage leads are symmetrical in the type of metal used and how they are joined, and by keeping unnecessary heat sources away from the leads. Even in a well designed system thermal EMF voltages can be an appreciable part of a low voltage sensor measurement.

The Model 331 can help with a thermal correction algorithm. The instrument will automatically reverse the polarity of the current source every other reading. The average of the positive and negative sensor readings will cancel the thermal EMF voltage which is present in the same polarity, regardless of current direction.

To turn reversal on or off press the **Input Setup** key and press the **Enter** key until the following display appears.

```
Select for InputA ▲▼
Reversal Off
```

Resistor sensors have the additional choice of turning current reversal On or Off, with the default being Off. If turned On, the Model 331 will automatically reverse the polarity. Press the **Enter** key. Proceed to Paragraph 4.5.2 to select a temperature curve or press the **Escape** key to return to the normal display.

4.4.4 Thermocouple Sensor Input Setup (Model 331X-TX only)

The following thermocouple screens are only displayed when the Model 331 hardware is configured at the factory with one or two thermocouple sensor inputs; being Model 331X-T1 or T2.

The user has the choice of two different input voltage ranges: ± 25 mV and ± 50 mV. The ± 25 mV range is recommended for cryogenic applications or higher temperatures less than 500 K. Since thermocouple voltage can exceed 25 mV on some thermocouple types, the ± 50 mV range is recommended for temperatures above 500 K.

The voltage range for Inputs A and B is set independently. To setup a thermocouple sensor input, press the **Input Setup** key. The first screen appear as follows.

```
Select With ▲▼
Input Setup Input A
```

Use the ▲ or ▼ key to toggle between Input A and B. Press the **Enter** key.

```
Select for InputA ▲▼
Type Thermo/25mV
```

Use the ▲ or ▼ key to cycle through the sensor types shown in Table 4-1, with “Thermo/25mV” and “Thermo/50mV” being the relevant choices. Press the **Enter** key. Proceed to Paragraph 4.4.3.1 to select a room-temperature compensation or press the **Escape** key to return to the normal display.

4.4.4.1 Room-Temperature Compensation

Room-temperature compensation is required to give accurate temperature measurements with thermocouple sensors. It corrects for the temperature difference between the instrument thermal block and the curve normalization temperature of 0 °C. An external ice bath is the most accurate form of compensation, but is often inconvenient. The Model 331 has built-in room-temperature compensation that is adequate for most applications. The built-in compensation can be turned on or off by the user. It operates with any thermocouple type that has an appropriate temperature response curve loaded. Room-temperature compensation is not meaningful for sensor units measurements.

NOTE: Room temperature compensation should be calibrated as part of every installation.

To turn room temperature compensation on or off, press the **Input Setup** and press **Enter** until the following display appears.

```
Select for InputA ▲▼
Room Comp On
```

Use the ▲ or ▼ key to turn room-temperature compensation on or off, then press the **Enter** key. The default setting is On. If curve is set to “None” the room-temperature compensation selection is automatically turned off.

4.4.4.2 Room-Temperature Calibration Procedure

Room-temperature calibration is used to calibrate the built-in compensation and is recommended when a thermocouple is first installed or any time a thermocouple is changed.

Factory calibration of the instrument is accurate to within approximately ± 1 K. Differences in thermocouple wire and installation technique create errors greater than the instrument errors.

Therefore, the best accuracy is achieved by calibrating with the thermocouple actually being used because it eliminates all sources of error. If that is not possible, use a thermocouple made from the same wire. For less demanding applications, a short across the input terminals will suffice. If the Model 331 is configured as dual thermocouple unit, calibrate both inputs even if they use the same type of thermocouple. An appropriate curve must be selected and room temperature compensation must be turned on before calibration can be started.

There are three options for room temperature calibration:

Cleared. The previous room-temperature calibration value is cleared and no adjustment will be made to the temperature value provided by the internal temperature sensor when compensation is on.

No. Use the room-temperature calibration value determined the last time the room-temperature calibration procedure was performed.

Yes. Perform the room-temperature calibration procedure that follows.

Calibration Procedure

1. Attach a thermocouple sensor or direct short across the input terminals of the thermocouple input. See Figure 3-4 for polarity.
2. Place the instrument away from drafts. If calibrating using a short, place an accurate room-temperature thermometer near the terminal block.
3. Allow the instrument to warm up for at least $\frac{1}{2}$ hour without moving or handling the sensor.
4. If calibrating with a short skip to step 6, otherwise insert the thermocouple into the ice-bath, liquid nitrogen, helium dewar, or other know fixed temperature. The temperature should be close to the measurement temperature that requires best accuracy.
5. Read the displayed temperature. If the temperature display is not as expected, check to be sure that the thermocouple is making good thermal contact. If possible, add a thermal mass to the end of the thermocouple.
6. Press the **Input Setup** key and press the Enter key until the "Room Cal" screen appears. Press the **▲** or **▼** key until the "Yes" selection appears then press the **Enter** key.

Select for InputA ▲▼
Room Cal Yes

7. The current temperature reading is displayed in Kelvin.

Select for InputA
Temp 294.15k

Enter the true temperature that the thermocouple should read. If input is shorted, then enter the actual room temperature measured by the thermometer. Press the **Enter** key to save the value.

8. To verify calibration, check that the temperature reading for the calibrated input matches the room-temperature calibration setting value.

4.5 CURVE SELECTION

The Model 331 supports a variety of temperature sensors sold by Lake Shore and other manufacturers. After the appropriate sensor type is selected for each of the two inputs (Paragraph 4.4), an appropriate curve may be selected for each input. The Model 331 can use curves from several sources. Standard curves are included with every instrument and numbered 1 – 20. User curves, numbered 21 – 41, are loaded when a sensor does not match a standard curve. CalCurve options are stored as user curves. SoftCal calibrations are stored as user curves or user can enter their own curves from the front panel (Paragraph 5.2) or computer interface (Chapter 6). The complete list of sensor curves built in to the Model 331 is provided in Table 4-2.

During normal operation, only the curves related to the input type you have selected are displayed. If the curve you wish to select does not appear in the selection sequence make sure the curve format matches the recommended format for the input type selected. Refer to Table 4-1.

NOTE: The sensor reading of the instrument can always be displayed in sensor units. If a temperature response curve is selected for an input, its readings may also be displayed in temperature.

Table 4-2. Sensor Curves

Curve Number	Display	Sensor Type	Model Number	Temperature Range	For Data Points, Refer To:
01	DT-470	Silicon Diode	DT-470	1.4 – 475 K	Table D-1
02	DT-670	Silicon Diode	DT-670	1.4 – 500 K	Table D-2
03	DT-500-D *	Silicon Diode	DT-500-D	1.4 – 365 K	Table D-3
04	DT-500-E1 *	Silicon Diode	DT-500-E1	1.1 – 330 K	Table D-3
05	Reserved	–	–	–	–
06	PT-100	100Ω Plat/250 100Ω Plat/500	PT-100	30 – 800 K	Table D-4
07	PT-1000 *	1000Ω Plat	PT-1000	30 – 800 K	Table D-4
08	RX-102A-AA	NTC RTD	Rox RX-102A	0.05 – 40 K	Table D-5
09	RX-202A-AA	NTC RTD	Rox RX-202A	0.05 – 40 K	Table D-6
10	Reserved	–	–	–	–
11	Reserved	–	–	–	–
12	Type K	Thermo/25mV & 50mV	Type K	3 – 1645 K	Table D-7
13	Type E	Thermo/25mV & 50mV	Type E	3 – 1274 K	Table D-8
14	Type T	Thermo/25mV & 50mV	Type T	3 – 670 K	Table D-9
15	AuFe 0.03% *	Thermo/25mV & 50mV	AuFe 0.03% *	3.5 – 500 K	Table D-10
16	AuFe 0.07%	Thermo/25mV & 50mV	AuFe 0.07%	3.15 – 610 K	Table D-11
17	Reserved	–	–	–	–
18	Reserved	–	–	–	–
19	Reserved	–	–	–	–
20	Reserved	–	–	–	–
21 – 41	User Curves	–	–	–	–

* No longer sold by Lake Shore.

4.5.1 Diode Sensor Curve Selection

Once the input is setup for the Silicon or Gallium-Aluminum-Arsenide Diode (Paragraph 4.4.1), you may choose a temperature curve. Standard curve numbers 1 thru 4, or none, being relevant choices. You are also given the choice of "None." You may also choose from any appropriate User Curves stored in Curve Numbers 21 thru 41. Data points for standard diode curves are detailed in Tables D-1 thru D-3 in Appendix D.

Press the **Input Setup** key. Press the **Enter** key until you see the curve selection screen shown below.

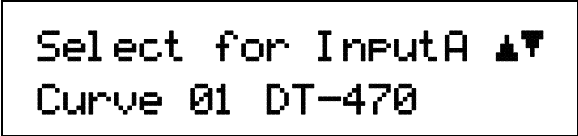

```
Select for InputA ▲▼  
Curve 01 DT-470
```

Use the ▲ or ▼ key to cycle through the sensor curves until the desired curve is displayed. Press the **Enter** key to return to the normal display.

NOTE: Standard diode curves and typical sensor performance (Table 1-3) are calculated using 10 μ A excitation. Sensor temperature response characteristics will be altered if 1 mA excitation is selected.

4.5.2 Resistor Sensor Curve Selection

Once the input is setup for the Platinum, Rhodium-Iron, or various NTC RTD sensors (Paragraph 4.4.2), you may choose a temperature curve. Standard curve numbers 6 and 7 being relevant to Platinum, or curves 8 and 9 being relevant to Rox™ sensors. You are also given the choice of "None." You may also choose from any appropriate User Curves stored in Curve Numbers 21 thru 41. Data points for resistor curves are detailed in Tables D-4 thru D-6 in Appendix D.

Press the **Input Setup** key. Press the **Enter** key until you see the curve selection screen shown below.



```
Select for InputA ▲▼  
Curve 08 RX-102A-AA
```

Use the ▲ or ▼ key to cycle through the sensor curves until the desired curve is displayed. Press the **Enter** key to return to the normal display.

4.5.3 Thermocouple Sensor Curve Selection

The following thermocouple screens are only displayed when the Model 331 hardware is configured at the factory with one or two thermocouple sensor inputs; being Model 331X-T1 or -T2.

Once the input is setup for the thermocouple input voltage (Paragraph 4.4.3), you may choose a temperature curve. Press the **Input Setup** key. Standard curve numbers 12 thru 16 being relevant. You are also given the choice of "None." You may also choose from any appropriate User Curves stored in Curve Numbers 21 thru 41. Data points for thermocouple curves are detailed in Tables D-7 thru D-11 in Appendix D. Press the **Enter** key until you see the curve selection screen shown below.



```
Select for InputA ▲▼  
Curve 16 AuFe 0.07%
```

Use the ▲ or ▼ key to cycle through the sensor curves until the desired curve is displayed. Press the **Enter** key to return to the normal display.

4.6 TEMPERATURE CONTROL

There are many steps involved in setting up a temperature control loop. Chapter 2 of this manual describes the principals of closed loop (feedback) control. Chapter 3 describes necessary hardware installation. The following sections of this chapter describe how to operate the control features and set control parameters. Each control parameter should be considered before enabling a control loop or the instrument may not be able to perform the most simple control functions. A good starting point is deciding which control loop to use, whether to operate in open or closed control mode and which tuning mode is best for the application. Other parameters fall into place once these have been chosen.

4.6.1 Control Loops

The Model 331 is capable of running either one (331E) or two simultaneous (331S) control loops. Their capabilities are compared in Table 4-3. As shown there the primary difference between the two loops is their control output.

Loop 1: Loop 1, the primary control loop, is the traditional control loop for a cryogenic temperature controller. It includes the largest set of hardware and software features making it very flexible and easy to use. Loop 1 uses the heater output as its control output giving it several advantages. The heater output is a well regulated 50 W DC output with three power ranges. This provides quiet, stable control for a broad range of temperature control systems in a fully integrated package.

Loop 2: Loop 2, the auxiliary control loop (331S only), shares most of the operational features of loop 1 but uses the 1 W analog voltage output as its control output. By itself, loop 2 is capable of driving a sample heater or other low power load. It is also well suited to drive the programming input of a voltage programmable power supply. In combination the controller and supply can be used to control large loads at high temperatures, or can be used in bipolar mode to control thermoelectric devices.

The keypad and display operate on one loop at a time. To toggle display and keypad operation between loop 1 and loop 2 press the **Loop** key to toggle the display and keypad operation between Loop 1 and 2. A brief display message indicates which control loop has been selected. You can determine which loop is active by looking at the heater output display. Loop 1 has “Low,” “Med,” or “High” in the heater display. Loop 2 has “L2” in the heater display. Also, when you select any of the following parameters, the active loop number will be displayed: Control Setup, Setpoint, PID/MHP, Zone Settings, AutoTune, and Heater Range.

Table 4-3. Comparison of Control Loops 1 and 2

Feature	Loop 1	Loop 2 (Model 331S Only)
Control Output	Heater Output	Analog Output
Maximum Output Power	50 W	1 W
Output Type	Current Source	Voltage Source
Multiple Output Ranges	Yes	No
Closed Loop PID Control	Yes	Yes
AutoTune	Yes	Yes
Zone Tuning	Yes	Yes
Ramping	Yes	Yes
Open Loop Control	Yes	Yes
Display in Current or Power	Yes	No
Front Panel Display	Yes	Yes
Setpoint Limit	Yes	Yes
Heater Fault Detection	Yes	No
Bipolar Operation	No	Yes

4.6.2 Control Modes

The Model 331 offers two control modes, closed loop and open loop. To select a control mode refer to Paragraph 4.7.

Closed Loop Control: Closed loop control, often called feedback control, is the control mode most often associated with temperature controllers. In this mode the controller attempts to keep the load at exactly the user entered setpoint temperature. To do this, it uses feedback from the control sensor to calculate and actively adjust the control output or heater setting. The Model 331 uses a control algorithm called PID that refers to the three terms used to tune the controller for each unique system. Manual heater power output can also be used during closed loop control. Closed loop control is available for both control loops and offers several methods of tuning.

Open Loop Control: Open loop control is less complicated than closed loop control but is also less powerful. Open loop control mode allows the user to directly set the manual heater power output for Loop 1, control output for Loop 2, using only the Manual Heater Power (MHP) output parameter. During Open Loop control only the heater range and MHP Output parameters are active, the setpoint, control sensor and PID parameters are ignored. This type of control guarantees constant power to the load but it does not actively control temperature. Any change in the characteristics of the load will cause a change in temperature. Closed loop control is available for both loops and no tuning is required.

4.6.3 Tuning Modes

The Model 331 offers three tuning modes or ways to set the necessary P, I and D parameters for closed loop control. MHP output is active during closed loop control and must be set to zero if not wanted. Heater range must also be considered as part of tuning when using control Loop 1.

Manual PID Tuning: Manual tuning is the most basic tuning method. The user manually enters parameter values for P, I and D as well as heater range using their knowledge of the cooling system and some trial and error. Refer to Paragraphs 2.7 and 4.8 for guidelines. Manual tuning can be used in any situation within the control capabilities of the instrument.

AutoTune: The Model 331 automates the tuning process with an AutoTune algorithm. This algorithm measures system characteristics after a setpoint change and calculates P, I and D. The user must set heater range. AutoTune will not work in every situation. Refer to Paragraphs 2.8 and 4.9 for details.

Zone Tuning: Optimal control parameters values are often different at different temperatures within a system. Once values have been chosen for each temperature range or zone, the zone feature can automatically select the correct set each time the setpoint is changed. This mode does not help choose control parameter values; it helps use the values more efficiently. Refer to Paragraphs 2.9 and 4.10 for details.

4.7 CONTROL SETUP

After the Input Setup has been completed (Paragraph 4.4) and Loop is selected (Paragraph 4.6.1), the user can begin to setup temperature control parameters.

Control input is the sensor input that is used for control feedback in closed loop control. Either Input A or B can be assigned to either Loop 1 or 2. It is not recommended to assign both loops to one input. Control input is ignored when using open loop control mode. To change control input, press the **Control Setup** key and the following screen will appear.

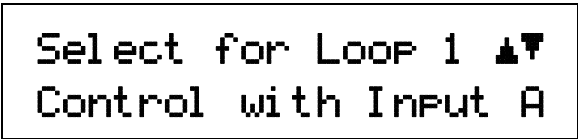

```
Select for Loop 1 ▲▼  
Control with Input A
```

Use the ▲ or ▼ key to toggle between Input A or B. Press the **Enter** key to accept the setting and continue with additional selections. You can press the **Escape** key anytime to exit the routine.

Control Setup (Continued)

The control setpoint can be displayed and set in temperature or sensor units. Changing setpoint units does not change operation of the controller, only the way the setpoint is displayed and entered. A valid curve must be assigned to the control input to use temperature units. To change setpoint units press the **Control Setup** key and press **Enter** until the following display appears.

```

Select for Loop 1 ▲▼
SP Units Temp K
    
```

Use the ▲ or ▼ key to cycle through the following setpoint units: Temp K, Temp C, and Sensor, where K = kelvin, C = degrees Celsius, and Sensor = volts (V) or ohms (Ω). Press the **Enter** key.

The Model 331 has two control modes, Closed Loop and Open Loop. Closed Loop control, often called feedback control, is described in Paragraph 2.6 of this manual. During closed loop control, operation the Control Input, Setpoint, Heater Range, PID, and Manual Heater Power (MHP) output parameters are active. Open loop control mode allows the user to directly set the heater output for Loop 1, control output for Loop 2 with the MHP Output parameter. During Open Loop control only the heater range and MHP Output parameters are active. To change Control Mode press the **Control Setup** key and press **Enter** until the following display appears.

```

Select for Loop 1 ▲▼
Control Mode Closed
    
```

The Power Up setting refers to how the control output will respond after the instrument is powered down. Power Up Enable means the controller will power up with the control output in the same state it was before power was turned off. Power Up Disable means the controller will always power up with the heater off no matter how it was set when power was turned off. To change the Power Up parameter press the Control Setup key and press Enter until the following display appears.

```

Select for Loop 1 ▲▼
Power Up Disable
    
```

Use the ▲ or ▼ key to toggle between Power Up Enable or Disable. Press the **Enter** key. The Model 331 will display the heater output as either percent of full scale current or percent of full scale power for the heater range selected for Loop 1. For Loop 2 the control output is always reported in percent of full scale voltage and this parameter will not appear in the Control Setup menu. This parameter affects the heater output display and the scale of the Manual Heater Power (MHP) output parameter for Loop 1. The MHP Output scale is always the same as the control output display. To change control output units press the **Control Setup** key and press **Enter** until the following display appears.

```

Select for Loop 1 ▲▼
Heater Out Power
    
```

Use the ▲ or ▼ key to toggle between Heater Out Power or Current. Press the **Enter** key.

4.8 MANUAL TUNING (Closed-Loop PID Control)

In manual PID mode, the controller will accept user-entered Proportional, Integral, and Derivative parameters to provide three-term PID control. Manual heater power output can be set manually in open loop and closed loop control modes. For details on PID tuning refer to Paragraph 2.7.

To place the controller in Manual PID tuning mode, press the **AutoTune** key, and press the **▲** or **▼** key until you see the following display.

```
Select for Loop 1 ▲▼
Tune Mode Manual PID
```

Press the **Enter** key. The controller is now in Manual PID mode.

4.8.1 Manually Setting Proportional (P)

The proportional parameter (also called gain) is the P part of the PID control equation. It has a range of 0 to 1000 with a resolution of 0.1. Enter a value greater than zero for P when using closed loop control.

To set Proportional, press the **PID/MHP** key. You will see the following display.

```
Enter for Loop 1
Prop (P)      50.0
```

The Proportional (gain) limit is entered using the numeric keypad, which includes the numbers 0–9, +/–, and decimal point. Proportional has a range of 0.1 to 1000 with a default of 50. Press the **Enter** key, then the **Escape** key to return to the normal display.

4.8.2 Manually Setting Integral (I)

The integral parameter (also called reset) is the I part of the PID control equation. It has a range of 0 to 1000 with a resolution of 0.1. Setting I to zero turns the reset function off. The I setting is related to seconds by:

$$I_{\text{setting}} = \frac{1000}{I_{\text{seconds}}}$$

For example, a reset number setting of 20 corresponds to a time constant of 50 seconds. A system will normally take several time constants to settle into the setpoint. The 50 second time constant, if correct for the system being controlled, would result in a system that stabilizes at a new setpoint in between 5 and 10 minutes.

To set Integral, press the **PID/MHP** key then press **Enter** until you see the following display.

```
Enter for Loop 1 I
Integ (I)     20.0
```

The Integral (reset) is entered using the numeric keypad, which includes the numbers 0–9, +/–, and decimal point. Integral has a range of 0.1 to 1000 with a default of 20. Press the **Enter** key, then the **Escape** key to return to the normal display.

4.8.3 Manually Setting Derivative (D)

The derivative parameter (sometimes called rate) is the D part of the PID control equation. The rate time constant should normally be somewhere between 1/4 and 1/8 the integral time in seconds, if used at all. As a convenience to the operator, the Model 331 Derivative time constant is expressed in percent of 1/4 the integral time. The range is between 0 and 200%. Start with settings of either 0%, 50%, or 100%, and determine which setting gives you the type of control you desire. Do not be surprised if the setting you prefer is 0. Note that by using a percent of integral time, derivative scales automatically with changes in the integral value and does not have to be revisited frequently.

To set Derivative, press the **PID/MHP** key then press **Enter** until you see the following display.

```

Enter for Loop 1 D
Deriv (D)      0.0
```

The Derivative (rate) is entered using the numeric keypad, which includes the numbers 0–9, +/-, and decimal point. Derivative has a range of 0 to 200 percent with a default of 0. Press the **Enter** key to accept the new setting, then the **Escape** key to return to the normal display.

4.8.4 Setting Manual Heater Power (MHP) Output

Manual Heater Power (MHP) output is a manual setting of control output. It can function in two different ways depending on control mode. In open loop control mode, the MHP output is the only output to the load. The user can directly set control output from the front panel or over computer interface. In closed loop control mode, the MHP output is added directly to the output of the PID control equation. In effect, the control equation operates about the MHP output setting.

Manual heater power output setting is in percent of full scale. When using the heater on Loop 1, percent of full scale is defined as percent of full scale current or power on the selected heater range. Manual heater power output setting range is 0% to 100% with a resolution of 0.001%.

When using Loop 2 analog voltage output the setting range is 0 to +100% and resolution is 0.001% but the actual resolution of the output is only 0.003%.

To enter a MHP Output setting, press the **PID/MHP** key and press **Enter** until the following display appears.

```

Enter for Loop 1
Manual Out     0.00%
```

The MHP Output setting is entered using the numeric keypad, which includes the numbers 0–9, +/-, and decimal point. Press the **Enter** key, then the **Escape** key to return to the normal display.

4.9 AUTO TUNE (Closed-Loop PID Control)

The Model 331 automates the tuning process of typical cryogenic systems with the AutoTune feature. For additional information about the algorithm refer to Paragraph 2.8.

Before initiating AutoTune the cooling system must be set up properly with control sensor and heater making it capable of closed-loop control. AutoTune works only with one control loop at a time and does not set the manual heater power output or heater range. The control sensor must have a valid temperature response curve assigned to it. An appropriate heater range must also be determined as described in Paragraph 2.7.1. Choosing good initial control parameters by experimenting with Manual PID tuning can speed up the AutoTune process. If no initial parameters are known start with the default values of P = 50 and I = 20. It is better to set an initial P value that causes the system to be more active than desired. Starting with a low P value can increase the time and number of attempts required to tune.

There are three AutoTune modes available. They result in slightly different system characteristics. Auto PI is recommended for most applications.

Auto P – Sets only the P parameter value. I and D are set to 0 no matter what the initial values are. This mode is recommended for systems that have very long lag times or nonlinearity that prevents stable PI control. Expect some overshoot or undershoot of the setpoint and stable temperature control below the setpoint value.

Auto PI – Sets values for both P and I parameters. D is set to zero. This mode is recommended for stable control at a constant temperature. It may take slightly longer to stabilize after setpoint change than Auto PID. Expect some overshoot or undershoot of the setpoint and stable temperature control at the setpoint value.

Auto PID – Sets values for P, I and D parameters. D is always set to 100%. This mode is recommended when setpoint changes are frequent but temperature is allowed to stabilize between changes. Stability at setpoint may be worse than Auto PI in noisy systems. Expect slightly less overshoot or undershoot than the other modes and control at the setpoint value.

Once AutoTune mode is selected, the Tune annunciator turns on steady to indicate that AutoTune is on. No activity takes place until the setpoint is changed at least 0.5 K. At that time, the Tune annunciator blinks to indicate the instrument is gathering data. This process takes from 1 to 17 minutes depending on the system reaction time. The tune annunciator stops blinking when calculations are complete and new parameter values have been stored. The annunciator will also stop blinking if the algorithm is unable to complete. Possible reasons include: setpoint change too small, manual control parameter changed during tuning, heater not turned on, or control sensor curve not selected.

If the controller is not tuned satisfactorily on the first attempt, make several small (2 degree) setpoint changes to see if better parameter values are calculated.

To select an AutoTune mode press the **AutoTune** key, and press either the ▲, ▼, or **AutoTune** key to cycle the display to AutoTune PID. You will see the following display.

```

Select for Loop 1 ▲▼
Tune Mode Auto PID
```

Use the ▲ or ▼ key to cycle between Auto PID, Auto PI, and Auto P. Press the **Enter** key. The controller is now in Autotuning mode. When the AutoTune feature is on, the front panel **Tune** LED will be on steady. When there is a setpoint change and the Model 331 is actively gathering data, the **Tune** LED will blink.

4.10 ZONE SETTINGS (Closed-Loop Control Mode)

The Model 331 allows the user to establish up to 10 custom contiguous temperature zones where the controller will automatically use pre-programmed PID values and heater ranges. Zone control can be active for both control loops at the same time. The user should configure the zones using 01 as the lowest to 10 as the highest zone. Zone boundaries are always specified in kelvin (K). The bottom of the first zone is always 0 K, therefore, only the upper limit is required for all subsequent zones. Make a copy of Figure 4-4 to plan your zones.

Once all zone parameters have been programmed, the controller must be placed in zone tuning mode. To do this, press the **AutoTune** key. Use the **▲** or **▼** key to select Zone. Then press **Enter** to accept the new tuning mode. Once zone is turned on, the instrument will update the control settings each time the setpoint is changed to a new zone. If the settings are changed manually, the controller will use the new setting while it is in the same zone and update to the zone table settings when the setpoint is changed to a value outside that zone.

To enter parameter values into the zone table, press the **Zone Settings** key. You will see the following display.

```
Select for Loop 1 ▲▼
Zone 01
```

Use the **▲** or **▼** key to cycle through the ten zones. Once the desired zone is displayed, press the **Enter** key. You will see the next display.

```
Enter for Zone 01
SP Limit 0.0000k
```

The upper setpoint limit is entered using the numeric keypad, which includes the numbers 0–9, +/–, and decimal point. During numeric entry, you can press the **Escape** key one time to clear the entry, and a second time to exit to the normal display.

NOTE: The default setting for all the zone setpoints is zero (0). The Model 331 will not search for additional zones once it encounters a setpoint of zero.

Press the **Enter** key to accept the new upper limit. You will see the next display.

```
Enter for Zone 01
Prop (P) 50.0
```

The Proportional (P) value is entered using the numeric keypad, which includes the numbers 0–9, +/–, and decimal point. Proportional has a range of 0.1 to 1000 with a default of 50. Press the **Enter** key to accept the new setting. You will see the next display.

Zone Settings (Continued)

```

Enter for Zone 01
Integ (I)    20.0
    
```

The Integral (I) value is entered using the numeric keypad, which includes the numbers 0–9, +/-, and decimal point. Integral has a range of 0.1 to 1000 with a default of 20. Press the **Enter** key to accept the new setting. You will see the next display.

```

Enter for Zone 01
Deriv (D)    0.0
    
```

The Derivative (D) value is entered using the numeric keypad, which includes the numbers 0–9, +/-, and decimal point. Derivative has a range of 0 to 200 percent with a default of 0. Press the **Enter** key to accept the new setting. You will see the next display.

```

Enter for Zone 01
Manual Out   0.00%
    
```

The MHP Output setting is entered using the numeric keypad, which includes the numbers 0–9, +/-, and decimal point. Manual heater has a range of 0.001 to 100 percent with a default of 0. Press the **Enter** key to accept the new heater setting. Assuming the zone is controlling using Loop 1, you will see the next display.

```

Select for Zone01 ▲▼
Heater Range Off
    
```

Use the ▲ or ▼ key to select the Heater Range: High, Medium, Low, or Off. Press the **Enter** key to accept the new heater range and return to the normal display. (If you are controlling using Loop 2, the last heater range setting is omitted.) This completes the setting of Zone 01. Repeat the process for the subsequent zones.

Zone Setting WorkSheet

Zone 10	↑	Proportional (0.1-1000)	Integral (0.1-1000)	Derivative (0-200)	MHP Output (0-100%)	Setpoint: _____ K
						Heater Range
						Off Low Med High
Zone 09	↑	Proportional (0.1-1000)	Integral (0.1-1000)	Derivative (0-200)	MHP Output (0-100%)	Setpoint: _____ K
						Heater Range
						Off Low Med High
Zone 08	↑	Proportional (0.1-1000)	Integral (0.1-1000)	Derivative (0-200)	MHP Output (0-100%)	Setpoint: _____ K
						Heater Range
						Off Low Med High
Zone 07	↑	Proportional (0.1-1000)	Integral (0.1-1000)	Derivative (0-200)	MHP Output (0-100%)	Setpoint: _____ K
						Heater Range
						Off Low Med High
Zone 06	↑	Proportional (0.1-1000)	Integral (0.1-1000)	Derivative (0-200)	MHP Output (0-100%)	Setpoint: _____ K
						Heater Range
						Off Low Med High
Zone 05	↑	Proportional (0.1-1000)	Integral (0.1-1000)	Derivative (0-200)	MHP Output (0-100%)	Setpoint: _____ K
						Heater Range
						Off Low Med High
Zone 04	↑	Proportional (0.1-1000)	Integral (0.1-1000)	Derivative (0-200)	MHP Output (0-100%)	Setpoint: _____ K
						Heater Range
						Off Low Med High
Zone 03	↑	Proportional (0.1-1000)	Integral (0.1-1000)	Derivative (0-200)	MHP Output (0-100%)	Setpoint: _____ K
						Heater Range
						Off Low Med High
Zone 02	↑	Proportional (0.1-1000)	Integral (0.1-1000)	Derivative (0-200)	MHP Output (0-100%)	Setpoint: _____ K
						Heater Range
						Off Low Med High
Zone 01	↑	Proportional (0.1-1000)	Integral (0.1-1000)	Derivative (0-200)	MHP Output (0-100%)	Setpoint: _____ K
						Heater Range
						Off Low Med High
0 K	↑					0 K

C331-4-4.eps

Figure 4-4. Record of Zone Settings

4.11 SETPOINT

The control setpoint is the desired load temperature expressed in temperature or sensor units. Use sensor units if no temperature response curve is selected for the sensor input used as the control channel.

The control setpoint has its own units parameter. Set with the **Control Setup** key in Paragraph 4.7. Control channel readings can display in any units. Display units need not match setpoint units.

NOTE: If a curve is not assigned to the control input, control reverts to sensor units and the setpoint is set to the most current reading.

When changing setpoint units while the control loop is active, the Model 331 converts the control setpoint to the new control units for minimal disruption in control output.

Setpoint resolution depends on sensor type and setpoint units. With setpoint expressed in temperature, setpoint resolution is 0.001 degree for setpoints below 100, and 0.01 for setpoints between 100 and 1000. In sensor units, the setpoint resolution matches the display resolution for the sensor input type given in the specifications (Table 1-3).

The instrument allows a large setpoint range to accommodate a variety of sensors and units. With setpoint expressed in sensor units, setpoint range is unlimited. The user must determine suitability of a setpoint value. In temperature units, a safety feature limits the setpoint value to help prevent load damage load. The setpoint limit in the temperature response curve sets maximum safe temperature in kelvin for the sensor package. It can be verified by using the Curve Entry key. The setpoint is limited to a value less than or equal to the limit. If the setpoint value changes from the number entered when Enter is pressed, it is likely the setpoint exceeds the above limit or is inappropriate for the sensor type.

Once control setup parameters are configured (Paragraph 4.7) and the active control loop is selected (Paragraph 4.6.1), the desired temperature setpoint is entered by pressing the **Setpoint** key.

```

Enter for Loop 1
Setpoint   +77.350k
    
```

The setpoint is entered using the numeric keypad, which includes the numbers 0–9, +/-, and decimal point. Press the **Enter** key to accept the new setpoint or press the **Escape** key to cancel.

If the display format is configured to show the setpoint (Paragraph 4.3), you will see something resembling the following for a normal display.

```

A 77.236k B 295.22k
S 77.350k   50% Low
    
```

4.12 RAMP

The Model 331 generates a smooth setpoint ramp when the setpoint units are expressed in temperature. The user can set a ramp rate in degrees per minute with a range of 0 to 100 and a resolution of 0.1. Once the ramp feature is turned on, its action is initiated by a setpoint change. When a new setpoint is entered, the instrument changes the setpoint temperature from the old value to the new value at the ramp rate. A positive ramp rate is always entered and it is used by the instrument for ramps up and down in temperature.

The ramping feature is useful by itself but it is even more powerful when used with other features. Setpoint ramps are often used with zone control mode. As temperature is ramped through different temperature zones, control parameters are automatically selected for best control. Ramps can be initiated and status read back using a computer interface. During computer controlled experiments, the instrument generates the setpoint ramp while the computer is busy taking necessary data. AutoTune does not function during a setpoint ramp. The ramp rate disguises the reaction of the cooling system and no valid tuning data can be taken.

NOTE: When an incomplete ramp is shut off, the setpoint will remain on the most current setting, i.e., the reading will not jump to the end of the ramp.

NOTE: If the input type or input curve is changed while a ramp is in progress, both ramping and the heater are turned off.

NOTE: If Ramp is on and the setpoint is set to sensor units, the ramping function will remain on but when another setpoint is entered, the setpoint goes directly to the new setpoint value. The Ramp LED will stay on solid (no blinking).

To enable setpoint ramping, press the **Control Setup** key, then press the **Enter** key until you see the following display.

```
Select for Loop 1 ▲▼
Setpoint RAMP On
```

Use the ▲ or ▼ key to select Setpoint Ramp On. Press the **Enter** key. You will see the following.

```
Enter for Loop 1
RAMP Rate    0.0 K/m
```

The ramp rate is entered using the numeric keypad, which includes the numbers 0–9 and decimal point. The user can set a ramp rate in degrees per minute with a range of 0 to 100 and a resolution of 0.1. Ramp rate will be in the same units specified for the setpoint. Press the **Enter** key. The front panel **Ramp** LED will illuminate, indicating the ramp function is active. Any subsequent change in setpoint will ramp at the specified rate and the **Ramp** LED will blink while ramping is in progress.

If you wish to pause a ramp, press the **Setpoint** key then immediately press the **Enter** key. This stops the ramp at the current setpoint but leaves the ramping function activated. Then to continue the ramp, enter a new setpoint.

To turn the ramping feature off, press the **Control Setup** key, then press the **Enter** key until you see the following screen.

```
Select for Loop 1 ▲▼
Setpoint RAMP Off
```

Use the ▲ or ▼ key to select Setpoint Ramp Off. Press the **Enter** key then the **Escape** key. The Ramp LED will turn off.

4.13 HEATER RANGE AND HEATER OFF

Heater output for Loop 1 is a well-regulated variable DC current source. The Heater output is optically isolated from other circuits to reduce interference and ground loops. The Heater output for the main control loop (Loop 1) can provide up to 50 W of continuous power to a resistive heater load and includes two lower ranges for systems with less cooling power. Heater output is short-circuit protected to prevent instrument damage if the heater load is accidentally shorted.

Loop 1 Full Scale Heater Power at Typical Resistance

Heater Resistance	Heater Range	Heater Power
10 Ω	Low	100 mW
	Med	1 W
	High	10 W
25 Ω	Low	250 mW
	Med	2.5 W
	High	25 W
50 Ω	Low	500 mW
	Med	5 W
	High	50 W

NOTE: During normal operation, if the input type or input curve is changed for the control input, the heater will automatically shut off.

A common error condition that may appear is “HTR Open.” This error message will appear when the heater senses there is no load connected to the rear panel terminals. The user can correct this problem by properly connecting a heater load. It could also indicate a malfunction internal to the Model 331, such as a loose connection or a malfunctioning component, but this is much less likely. Other error messages are summarized in Paragraph 8.8.

Specifications of heater output are provided in [Paragraph 1.X](#) – Instrument Specifications. Heater theory of operation is provided in Paragraph 2.4 – Heater Selection and Installation. Various Heater installation considerations are provided in Paragraph 3.7 – Heater Output Setup.

The Model 331S only has the additional ability to configure the analog output as a variable DC voltage source capable of a 1 W output.

Once control setup parameters are configured (Paragraph 4.7), and the active control loop is selected (Paragraph 4.6.1), the desired heater range is selected by pressing the **Heater Range** key.

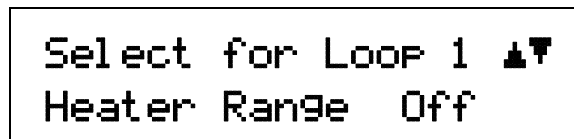

Use the ▲ or ▼ key to cycle through Loop 1 Heater settings: Off, Low, Med, and High. Once the desired heater setting is displayed, press the **Enter** key. You will return to the normal display.

For the Model 331S only, use the ▲ or ▼ key to toggle between Loop 2 Heater settings: Off and On. Once the desired heater setting is displayed, press the **Enter** key. You will return to the normal display.

NOTE: If the display shows Heater Disabled, the analog output does not have the proper parameter configuration to work as a control loop. Refer to Paragraph 4.16.

To immediately turn the heater off, press the **Heater Off** key. If the Heater Range is not being displayed on the front panel, the user should immediately press the **Heater Range** key to verify that the proper loop is displayed and the heater shows Off.

4.14 MATH

Three math features are included for convenience and aid in setting up experiments. Max and Min readings can be captured. A linear equation can be applied to input data to correct system errors or improve performance of the analog outputs. Readings can be filtered to quiet effects of a noisy environment. These math features can be performed on both sensor inputs, however, each input must be configured separately.

When you first press the **Math** key, you will see the following display.

```
Press Math to Reset,
Enter to Continue
```

Press the **Math** key again to reset the stored maximum and minimum values. This does not reset the math settings, it only resets the data that has been collected since the function was initiated or since the last math reset. The controller will return to the normal display. Otherwise, press the **Enter** key to continue to the math settings. The first screen appear as follows.

```
Select With ▲▼
Math Setup Input A
```

Use the **▲** or **▼** key to toggle between Input A and B. Press the **Enter** key to accept, or press the **Escape** key to cancel the entry and return to the normal display. All subsequent math functions will be set for the selected input. The following paragraphs detail the math settings in order of appearance.

4.14.1 Max/Min

The Max/Min feature captures and stores the highest (Max) and lowest (Min) reading taken since the last reset. The feature will only capture from one reading source at a time for each input. Temp K, Temp C, Sensor, and Linear selection determines the source for the selected sensor input:

- Temp K Kelvin temperature reading from input.
- Temp C Celsius temperature reading from input.
- Sensor Sensor units (V, mV, or Ω) reading from input.
- Linear Linear (/) equation data from input.

Max and Min are always being captured, so there is no need to turn the feature on or off. The readings are reset when the instrument is turned off, parameters related to the input are changed, or the Math/Reset sequence is performed.

To select a source for Max/Min continue from the Math Setup screen in Paragraph 4.14, press the **Enter** key to see the following display.

```
Select for Math A ▲▼
Mx/Mn Source Temp K
```

Use the **▲** or **▼** key to cycle through the data sources. The user must select a source for the Max/Min feature. After selecting the desired source, press the **Enter** key. Press the **Escape** key at any time to return to the normal display. The instrument retains values entered prior to pressing the **Escape** key.

Press the **Math** key twice to reset Max/Min. Max/Min automatically resets when the instrument is turned off or parameters related to the input change.

4.14.2 Linear

The Model 331 will process either of two simple linear equations for each sensor input: $MX+B$ or $M(X+B)$. The result can be displayed or directed to the analog voltage output.

There are two different equations available. In each: M is a gain or slope, X is an input reading, and B is an offset or intercept (not to be confused with input B). The two equations are shown in Table 4-4. The difference between them is subtle. The first equation is used to scale the raw reading of an input, similar to a temperature response curve, when the sensor has linear response. The second is better at generating a control signal when a setpoint (SP1 or SP2) is selected as B . The control signal can then be directed to an analog output. The second equation is also useful whenever a reading of deviation from setpoint is needed.

Table 4-4. Linear Equation Configuration

Equation	M	X	B
$M X + B$ $M (X + B)$	Number	Sensor Temp K Temp C	Number +SP1 -SP1 +SP2 -SP2

The columns settings in Table 4-4 are selected independently. "Number" represents a number entered by the user. "X" can be set to an input reading in sensor units or temperature in kelvin or Celsius. SP1 represents setpoint of Loop 1 and similarly for other B settings.

NOTE: When using the linear equations $MX+B$ or $M(X+B)$, the user should ensure that the setpoint and "x" variable units match. If the units do not match, the instrument will continue calculations, but results may not be what is expected.

To configure a linear equation continue from the math setup screen in Paragraph 4.14 and press the **Enter** key until the following display appears.

```

Select for Math A ▲▼
Linear Equ  MX+B
    
```

Use the **▲** or **▼** key to toggle between the two linear equations: $MX+B$ or $M(X+B)$, where: M = slope of a line, X = reading data from a sensor input, and B = offset of a line.

```

Enter for Math A
Lin Equ M  +0.0000
    
```

The Linear Variable M is entered using the numeric keypad, which includes the numbers 0–9, +/–, and decimal point. Press the **Enter** key to accept the new setting. You will see the next display.

```

Select for Math A ▲▼
X Source  Temp K
    
```

Use the **▲** or **▼** key to toggle between the Linear X Variable: Temp C, Temp K, Sensor. Press the **Enter** key to accept the new setting. You will see the next display.

```

Select for Math A ▲▼
B Source  Value
    
```

Linear (Continued)

Use the ▲ or ▼ key to toggle between the Linear B Variable: +SP1, -SP1, +SP2, -SP2, Value. Press the **Enter** key to accept the new setting. You will see the next display.

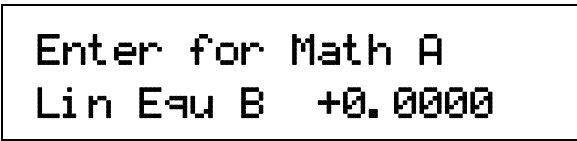

The Linear Variable B is entered using the numeric keypad, which includes the numbers 0–9, +/-, and decimal point. Press the **Enter** key to accept the new setting.

Press the **Escape** key to return to the normal display or continue with the Filter settings (Paragraph 4.14.3).

4.14.3 Filter

The reading filter applies exponential smoothing to the sensor input readings. If the filter is turned on for a sensor input, all reading values for that input are filtered. The filter is a running average so it does not change the update rate of an input. Filtered readings are not used for control functions but they are used for all input features including Max/Min.

The number of filter points determines how much smoothing is done. One filter point corresponds to one new reading on that input. A larger number of points does more smoothing but also slows the instruments response to real changes in temperature. The default number of filter points is 8 which settles in approximately 50 readings or 5 seconds.

The filter window is a limit for restarting the filter. If a single reading is different from the filter value by more than the limit the instrument will assume the change was intentional and restart the filter. Filter window is set in percent of full scale range.

To configure a filter, continue from the Math Setup screen in Paragraph 4.14, press the **Enter** key until the following display appears.

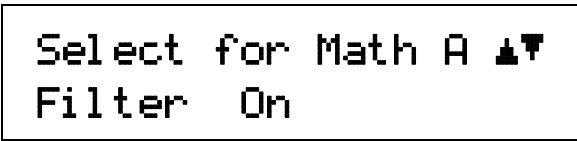

Use the ▲ or ▼ key to toggle between Filter On and Off. If you select Off, the routine will end and return you to the normal display. If you select On, the routine will continue with the following.

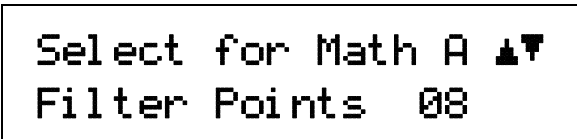

Use the ▲ or ▼ key to increment or decrement the Filter Points from 02 thru 64, with 08 being the default. Press the **Enter** key. You will see the following display.

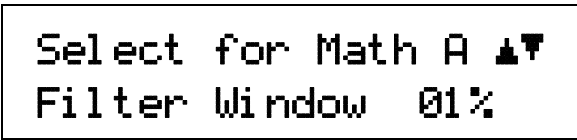

Use the ▲ or ▼ key to increment or decrement the Filter Window from 01% thru 10%, with 01% being the default. Press the **Enter** key. You will return to the normal display.

4.15 ALARMS AND RELAYS (Model 331S Only)

4.15.1 Alarms

Each input of the Model 331 has high and low alarm capability for each input. Input reading data from any source can be compared to the alarm setpoint values. A reading higher than the high setpoint triggers the high alarm for that input. A reading lower than the low alarm setpoint triggers the low alarm for that input.

The Alarm annunciator steadily displays when any alarm is enabled; it flashes when any alarm activates. An input need not display for the system Alarm annunciator to indicate input alarm status. The beeper inside the instrument can also be programmed to sound if any alarms activate. The two relays on a 331S can also be tied to alarm functions as described below.

Latching Alarms – Often used to detect faults in a system or experiment that require operator intervention. The alarm state remains visible to the operator for diagnostics even if the alarm condition is removed. Relays often signal remote monitors or for added safety take critical equipment off line. Pressing the **Alarm** key clears latched alarms.

Non-Latching Alarms – Often tied to relay operation to control part of a system or experiment. The alarm state follows the reading value. The dead band parameter can prevent relays from turning on and off repeatedly when the sensor input reading is near an alarm setpoint. **Example:** If the high alarm setpoint = 100 K and the dead band = 1 K, the high alarm triggers when sensor input temperature increases to 100 K, and it will not deactivate until temperature drops to 99 K. Figure 4-5 illustrates the interaction between alarm setpoint and dead band.

In Figure 4-5, with the high alarm setpoint at 100 K and the dead band at 5 K, the high alarm triggers when sensor input temperature increases to 100 K, and it will not deactivate until temperature drops to 95 K. In addition, the same 5 K dead band is applied to the low alarm setpoint as well.

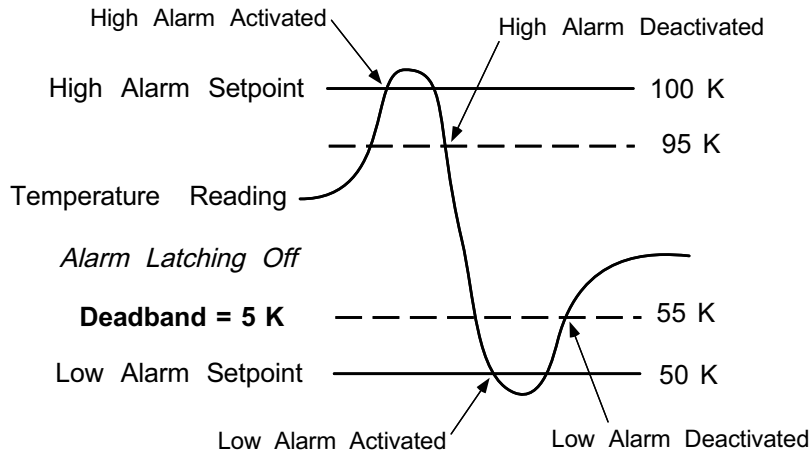

Figure 4-5. Deadband Example

To begin alarm setup, press the **Alarm** key.

```

Select With ▲▼
Alarm Setup Input A
    
```

Use the ▲ or ▼ key to toggle between Input A and B. Press the **Enter** key.

Alarms (Continued)

```

Select for Alm A ▲▼
Alarm On
    
```

Use the ▲ or ▼ key to toggle between Alarm On or Off. Press the **Enter** key.

```

Select for Alm A ▲▼
Source Temp K
    
```

Use the ▲ or ▼ key to cycle through the following data sources: Temp C, Temp K, Linear, or Sensor, where Temp C = degrees Celsius, Temp K = kelvin, Linear = $MX+B$ or $M(X+B)$ (refer to Paragraph 4.14.2), or Sensor = volts (V), millivolts (mV) or ohms (Ω). Press the **Enter** key.

```

Enter for Alarm A
Alarm Low      50k
    
```

The Low Alarm Point is entered using the numeric keypad, which includes the numbers 0–9, +/-, and decimal point. For this example, enter 50 K. Press the **Enter** key.

```

Enter for Alarm A
Alarm High    100k
    
```

The High Alarm Point is entered using the numeric keypad, which includes the numbers 0–9, +/-, and decimal point. For this example, enter 100 K. Press the **Enter** key.

```

Select for Alm A ▲▼
Alarm Latching Off
    
```

Use the ▲ or ▼ key to toggle between Latching On or Off. For this example, select Alarm Latching Off. Press the **Enter** key.

```

Enter for Alarm A
Dead Band      5k
    
```

The dead band is entered using the numeric keypad, which includes the numbers 0–9, +/-, and decimal point. Press the **Enter** key. The audible parameter determines whether the internal beeper will sound when an alarm is active. This is a global parameter so it is set once for all alarms.

After specifying either Alarm Setpoint On or Dead Band, next is the Alarm Audible screen.

```

Select With ▲▼
Alarm Audible On
    
```

Use the ▲ or ▼ key to toggle between Audible Alarm On or Off. For this example, select Audible Alarm On. Press the **Enter** key.

4.15.2 Relays (331S Only)

There are two relays on the Model 331S numbered 1 and 2. They are most commonly thought of as alarm relays, but may be manually controlled also. Relay assignments are configurable as shown in Figure 4-6. Two relays can be used with one sensor input for independent high and low operation.

When using relays with alarm operation, set up alarms first. The relays are rated for 30 VDC and 5 A. Their terminals are in the detachable terminal block on the Model 331S rear panel.

To configure Relay 1 press the Alarm key and press Enter until the following display appears.

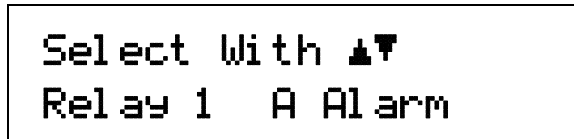

Use the ▲ or ▼ key to cycle through the options for Relay 1: Off, On, A Alarm, or B Alarm. Press the Enter key. If the relay is set to follow either the A or B Alarm, the following screen will appear.

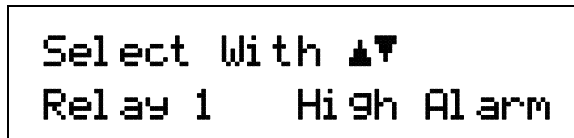

Use the ▲ or ▼ key to cycle through the relay alarm functions: Low Alarm, High Alarm, and Both Alarms. Press the Enter key.

Configuration for Relay 2 is identical to Relay 1.

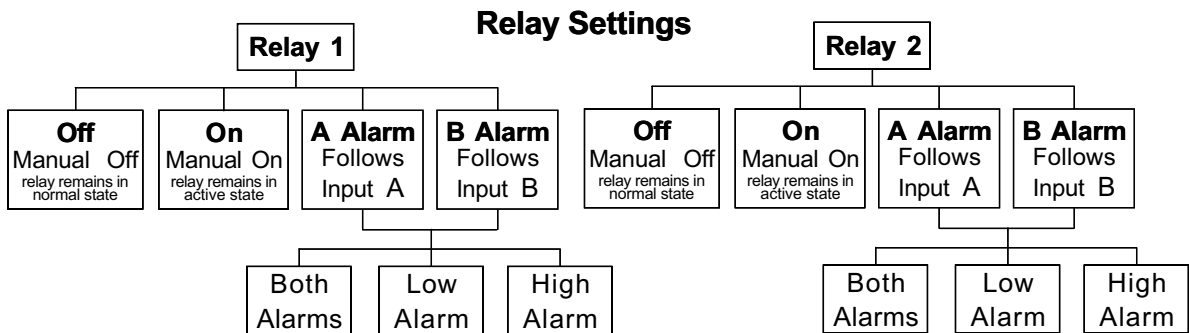

Off Manual Off. Relay remains in the normal state.

On Manual On. Relay remains in the active state.

A Alarm Relay will follow Input A alarms.

Both Alarms Relay active when either the High or Low Alarm is active.

Low Alarms Relay active only when the Low Alarm is active.

High Alarms Relay active only when the High Alarm is active.

B Alarm Relay will follow Input B alarms.

Both Alarms Relay active when either the High or Low Alarm is active.

Low Alarms Relay active only when the Low Alarm is active.

High Alarms Relay active only when the High Alarm is active.

Figure 4-6. Relay Settings

4.16 ANALOG OUTPUT (Model 331S Only)

The Model 331S has a single analog output on Pins 7 and 8 of the terminal block at the rear of the instrument. It is normally configured to send a voltage proportional to temperature to a strip chart recorder or separate data acquisition system. The output can also be manually controlled as a voltage source for any other application or used as the control output for Loop 2.

The analog output is a variable DC voltage source that can vary from +10V to -10V. The voltage is generated by a 16-bit D/A converter with resolution of 0.3 mV or 0.003% of full scale. The output is short-circuit protected but should never be used to drive a resistance lower than 100 Ω. When acting as the Loop 2 heater, the output can provide up to 1 W of power (0.1 A into a 100 Ω minimum heater load). For further specifications, refer to the Loop 1 and 2 comparison table in [Paragraph 1.X](#).

The analog output has four modes of operation: Off, Input, Manual, and Loop 2. If you select Off, the analog output is set to 0 volts and you are returned to the normal display. Once a mode is selected, the parameters associated with that mode follow on setting screens.

4.16.1 Analog Output In Input Mode

In Input mode, the analog output will track the input according to scaling parameters entered by the user. Press the **Analog Output** key.

```

Select with ▲▼
Analog Out Input A
    
```

Press the ▲ or ▼ key until Input A is showing. Press the **Enter** key.

```

Select for AnOut ▲▼
Source Temp K
    
```

Press the ▲ or ▼ key to cycle through the data source units: Temp K, Temp C, Sensor, or Linear, where K = kelvin, C = Celsius, Sensor = volts (V) or ohms (Ω), and Linear = MX+B or M(X+B) (refer to Paragraph 4.14.2). For this example, choose Temp K. Press the **Enter** key.

```

Select for AnOut ▲▼
Bipolar Mode On
    
```

Press the ▲ or ▼ key to toggle between Bipolar Mode On or Off.

Analog Output In Input Mode (Continued)

Bipolar mode refers to whether or not negative voltages are used, as shown below.

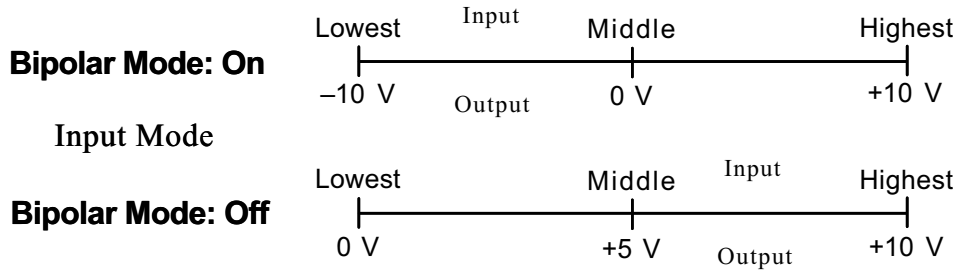

For this first example we will choose Bipolar Mode On. Press the **Enter** key.

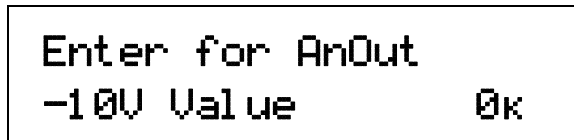

The -10 V value is entered using the numeric keypad, which includes the numbers 0–9, +/-, and decimal point. For this example, we will enter 0 K. Press the **Enter** key.



The +10 V value is entered using the numeric keypad, which includes the numbers 0–9, +/-, and decimal point. For this example, we will enter 100 K. Press the **Enter** key. You are returned to the normal display.

The analog output will now correspond to the input temperature as shown below. For example, if the actual reading was 50 K, the analog output would be at 0 V (middle of the scale).

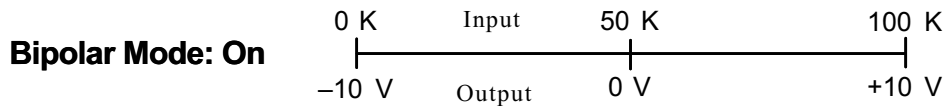

If we repeat the same procedure using all the same settings, but select Bipolar Mode Off, the output would be as shown below. In this case, if the actual reading was 50 K, the analog output would be +5 V (middle of the scale).

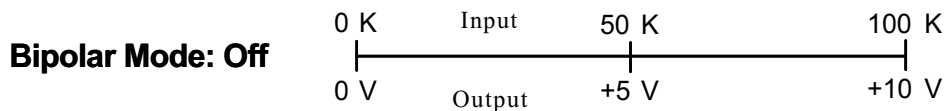

4.16.2 Analog Output In Manual Mode

In Manual mode, the analog output provide a fixed output according to a percentage of full scale entered by the user; -100.00% to +100.00% corresponding to -10 V to +10 V. The setting resolution on the display is 0.001% but the output itself is limited to 0.003%. Press the **Analog Output** key.

```

Select With ▲▼
Analog Out Manual
    
```

Press the ▲ or ▼ key until “Manual” is showing. Press the **Enter** key.

```

Select for AnOut ▲▼
Bipolar Mode On
    
```

Press the ▲ or ▼ key to toggle between Bipolar Mode On or Off. Bipolar mode refers to whether or not negative voltages are used, as shown below.

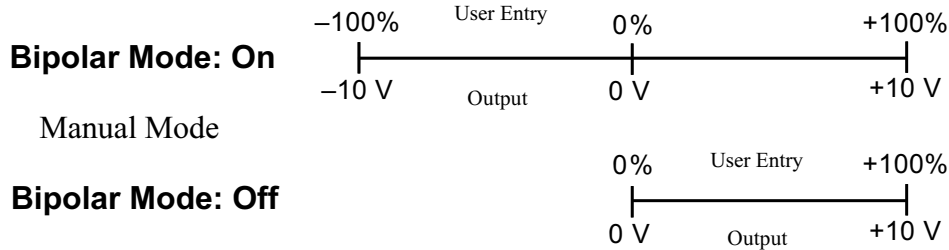

For this example, we will choose Bipolar Mode On. Press the **Enter** key.

```

Enter for AnOut
Manual Out - 50%
    
```

The desired fixed output you want as a percent of full scale is entered using the numeric keypad, which includes the numbers 0–9, +/-, and decimal point. For this example, we will enter -50%. Press the **Enter** key. The instrument will return to the normal display. The analog output will begin to output a constant voltage that is $-50\% \times 10 \text{ volts} = -5 \text{ volts}$.

In a second example, if you repeat the same procedure using all the same settings, but enter +75%, then the output would be $+75\% \times 10 \text{ volts} = +7.5 \text{ volts}$.

In a third example, if you repeat the same procedure, but choose Bipolar Off, enter +25%, then the output would be $+25\% \times 10 \text{ volts} = +2.5 \text{ volts}$. The difference being that any negative sign will be ignored with Bipolar Mode Off and the output will always be a positive voltage.

4.16.3 Analog Output In Loop 2 Mode

In Loop 2 mode, the analog output is directly controlled by Model 331. To place the analog output in Loop 2 mode, press the **Analog Output** key, then press the ▲ or ▼ key until you see the following display.

```
Select With ▲▼  
Analog Out Loop 2
```

Press the **Enter** key. The next screen is for control of Bipolar Mode.

```
Select for Loop 2 ▲▼  
Bipolar Mode Off
```

Press the ▲ or ▼ key to toggle between Bipolar Mode On or Off. Bipolar Mode On allows the control output to go negative. This is only needed when controlling a thermoelectric device. For most cases, Bipolar Mode should be Off. Press the **Enter** key. The instrument returns to the normal display.

4.17 LOCKING AND UNLOCKING THE KEYPAD

The keypad lock feature prevents accidental changes to parameter values. When the keypad is locked, some parameter values may be viewed, but most cannot be changed from the front panel. Alarm Reset and Heater Off are the only keypad functions that remain active when the keypad is locked.

A 3-digit keypad lock code locks and unlocks the keypad. The factory default code is **123**. The code can be changed only through the computer interface. If instrument parameters are reset to default values, the lock code resets also. The instrument cannot reset from the front panel with the keypad locked.

To lock the keypad, press and hold the **Enter** key for 10 seconds to display the screen shown as follows.

```
Enter Code To  
Lock Keypad
```

Use the numeric keypad to enter the 3-digit lock code. The keypad locks and the normal display appears. Changes attempted to any parameters result in a brief display of the *LOCKED* message.

To unlock the keypad, press and hold the **Enter** key for 10 seconds to display the screen shown as follows.

```
Enter Code To  
Unlock Keypad
```

Use the numeric keypad to enter the 3-digit lock code. The keypad unlocks and the normal display again appears. All Model 331 parameters are now accessible.

4.18 DISPLAY BRIGHTNESS

The user is able to control the brightness of the vacuum fluorescent display. Press and hold the **Display Format** key for several seconds until you see the following display.



Use the ▲ or ▼ key to select 25%, 50%, 75%, or 100%. Press the **Enter** key. The instrument returns to the normal display.

CAUTION: Prolonged use of the display brightness on the 100% setting will reduce the life of the vacuum fluorescent display.

4.19 REMOTE/LOCAL

“Local” refers to operating the Model 331 from the front panel. “Remote” refers to operating the controller via the IEEE-488 Interface. The keypad is disabled during remote operation. The mode of operation can be changed by pressing the **Remote/Local** key. When in the Local mode, the Remote LED in the upper right-hand corner of the front panel will be Off. When in the Remote mode, the Remote LED will be On.

4.20 INTERFACE

The **Interface** key serves three functions: set the Serial Interface Baud rate, set the IEEE-488 Interface Address and Terminators (Model 331S Only), and select the Model 330 Emulation Mode.

To set the Serial Interface Baud rate, press the **Interface** key.



Use the ▲ or ▼ key to cycle through the choices of 300, 1200, and 9600 Baud. The default Baud rate is 9600. Press the **Enter** key to accept the changes or the **Escape** key to keep the existing setting and return to the normal display.

On the Model 331S only, to set the IEEE-488 Interface Address and Terminators, press the **Interface** key, then press the **Enter** key until you see the following screen.



Use the ▲ or ▼ key to increment or decrement the IEEE Address to the desired number. The default address is 12. Press the **Enter** key to accept the changes or the **Escape** key to keep the existing setting and return to the normal display. Press the **Enter** key again to see the following screen.

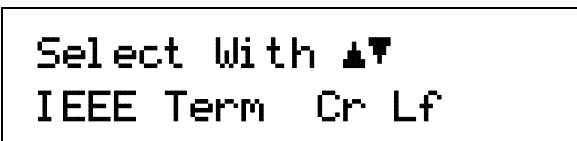

Interface (Continued)

Use the ▲ or ▼ key to cycle through the following Terminator choices: Cr Lf, Lf Cr, Lf, or EOI, where Cr = Carriage Return, Lf = Line Feed, and EOI = End Or Identify. The default terminator is Cr Lf. Press the **Enter** key to accept the changes and continue to the next screen, or the **Escape** key to keep the existing setting and return to the normal display.

```
Select With ▲▼  
Emulation Mode 331
```

Use the ▲ or ▼ key to toggle between 331 and 330. The default setting is 331. If 331 mode is selected, pressing the **Enter** key will return you to the normal display.

To support owners of the Lake Shore Model 330 Temperature Controller, 330 Emulation Mode is provided. The 330 Emulation Mode only affects remote operation; front panel operation of the Model 331 is not changed. In 330 Emulation Mode, curve locations are mapped to match Model 330 locations. For example, the DT-500-D Curve, found at curve location 3 in the Model 331, is mapped to location 0 when in 330 mode. This applies to the following remote commands: ACUR, ACUR?, BCUR, BCUR?. The following Model 330 commands are not supported in 330 Emulation Mode: CUID?, CURV, CURV?, ECUR, KCUR, and SCAL. Please refer to your Model 330 User's Manual for any additional questions concerning remote commands.

Selecting 330 Emulation Mode causes two additional screens to appear.

```
Select With ▲▼  
Sample Channel A
```

Use the ▲ or ▼ key to toggle between Sample Channel A or B. The default setting is A. Press the **Enter** key. You will see the following display.

```
Select With ▲▼  
Sample Units K
```

Use the ▲ or ▼ key to cycle through the Sample Units: K, C, and Sensor, where K = kelvin, C = degrees Celsius, and Sensor = volts (V) or ohms (Ω). The default setting is K. Press the **Enter** key. You will return to the normal display.

4.21 DEFAULT VALUES

It is sometimes necessary to reset instrument parameter values or clear out the contents of curve memory. Both are all stored in nonvolatile memory called NOVRAM but they can be cleared individually. Instrument calibration is not affected except for Room Temperature Calibration which should be redone after parameters are set to default values or any time the thermocouple curve is changed.

To reset the Model 331 parameters to factory default values, press and hold the **Escape** key until the screen shown below appears.

```
Code Date: 06/01/00  
Default Values Yes
```

Default Values (Continued)

Use the ▲ or ▼ key to select Yes or No to reset the NOVRAM. Select Yes to reset all Model 331 parameters to the defaults listed in Table 4-5. Press the **Enter** key. The second screen appears as follows.

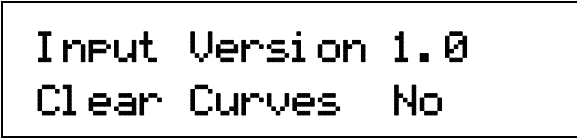

Use the ▲ or ▼ key to select Yes or No to clear the user curves (in locations 21–41) stored in the Model 331. Standard curves (in locations 1–20) are unaffected. Press the **Enter** key. The instrument performs the operation then returns to the normal display.

Table 4-5. Default Values

<p>Alarm and Relay Alarm..... Off Alarm Audible..... Off Relay 1..... Off Relay 2..... Off</p> <p>Analog Output Analog Output..... Off</p> <p>Control Setup Control Input Input A SP Units Temp K Control Mode Closed Power Up Disable Setpoint Ramp Off Heater Output Display.. Current</p> <p>Display Format Display Location 1..... Input A / Temp K Display Location 2..... Input B / Temp K Display Location 3..... Setpoint Display Location 4..... Heater Output Display Brightness 75%</p> <p>Heater Heater Range..... Off</p> <p>Input Setup – Diode/Resistor Configuration Input Type Silicon Diode Curve..... DT-470</p> <p>Input Setup – Thermocouple Configuration Input Type Thermocouple/25mV Curve..... Type K Room Comp On Room Cal Cleared</p> <p>Interface Baud..... 9600 IEEE Address..... 12 IEEE Terminators..... CR/LF Emulation Mode 331</p>	<p>Keypad Locking Mode..... Unlocked Lock Code 123</p> <p>Loop Selected Loop..... Loop 1</p> <p>Math Source Temp K Linear Equation MX+B Linear Equation M Value 0.0000 Linear Equation X Source ... Temp K Linear Equation B Source ... Value Linear Equation B Value..... 0.0000 Filter..... Off</p> <p>PID/Manual Heater Power (MHP) Output Proportional (P) 50.000 Integral (I) 20.000 Derivative (D)..... 0.0000 MHP Output..... 0.0000%</p> <p>Remote/Local Remote/Local Local</p> <p>Setpoint Setpoint Value 0.000K</p> <p>Tuning Tuning Mode..... Manual PID</p> <p>Zone Settings – All Zones Setpoint Limit..... 0.000K Proportional (P) 50.000 Integral (I) 20.000 Derivative (D)..... 0.0000 Manual Output..... 0.0000%</p>
---	--

CHAPTER 5

ADVANCED OPERATION

5.0 GENERAL

This chapter covers the advanced operation of the Model 331 Temperature Controller. Advanced operation consists of the functions related to temperature response curves. A temperature response curve can be entered into the Model 331 in several ways: order it factory-installed (Paragraphs 2.2 and 7.2), create a SoftCal curve (Paragraph 5.3); load a curve via the computer interface (refer to the various curve commands detailed in Paragraph 6.3), or enter a user-generated curve from the front panel. Advanced functions include details on curve numbers and storage in Paragraph 5.1, front panel curve entry operations in Paragraph 5.2, and SoftCal™ in Paragraph 5.3.

5.1 CURVE NUMBERS AND STORAGE

The Model 331 has 20 standard curve locations; numbered 1 thru 20. At present, not all locations are occupied by curves; the others are reserved for future updates. If a standard curve location is in use, the curve can be viewed using the edit operation. Standard curves can not be changed by the user, and reserved locations are not available for user curves.

The Model 331 has 20 user curve locations numbered 21 thru 41. Each location can hold from 2 to 200 data pairs (breakpoints) including a value in sensor units and a corresponding value in kelvin. Using fewer than 200 breakpoints will not increase the number of available curve locations. SoftCal generated curves are stored in user curve locations.

5.1.1 Curve Header Parameters

Each curve has a set of parameters that are used for identification and to allow the instrument to use the curve effectively. The parameters must be set correctly before a curve can be used for temperature conversion or temperature control.

Curve Number: 1 – 41.

Name: Defaults to the name **User Curve** for front panel entry. When entering a user curve over the computer interface, a curve name of up to 15 characters can be entered.

Serial Number: Up to a 10-character sensor serial number. Both numbers and letters can be entered over computer interface, only numbers can be entered from the front panel.

Format: The format parameter tells the instrument what breakpoint data format to expect. Different sensor types require different formats. Formats for Lake Shore sensors are:

V/K: Volts vs. Kelvin for Diode sensors.

Ω /K: Resistance vs. Kelvin for platinum RTD sensors.

Log Ω /K: Log Resistance vs. Kelvin for NTC resistive sensors.

Limit: Enter a temperature limit in Kelvin for the curve. Default is 375 K. Enter a setting of 9999 K if no limit is needed.

Temperature Coefficient: The unit derives the temperature coefficient from the first two breakpoints. The user does not enter this setting. If it is not correct check for proper entry of those points. A positive coefficient (**P**) indicates that the sensor signal increases with increasing temperature. A negative coefficient (**N**) indicates that the sensor signal decreases with increasing temperature.

5.1.2 Curve Breakpoints

Temperature response data of a calibrated sensor must be reduced to a table of breakpoints before entering it into the instrument. Each breakpoint consists of one value in sensor units and one temperature value in kelvin. Linear interpolation is used by the instrument to calculate temperature between breakpoints. From 2 to 200 breakpoints can be entered as a curve. The instrument will show an error message on the display if the sensor input is outside the range of the breakpoints. No special endpoints are required. Sensor units are defined by the format setting in Table 5-2.

Breakpoint setting resolution is six digits in temperature. Most temperature values are entered with 0.001 resolution. Temperature values of 1000 K and greater can be entered to 0.01 resolution. Temperature values below 10 K can be entered with 0.0001 resolution. Temperature range for curve entry is 1500 K.

Setting resolution is also six digits in sensor units. The curve format parameter defines the range and resolution in sensor units as shown in Table 5-2. The sensor type determines the practical setting resolution. Table 5-2 lists recommended sensor units resolutions. For most sensors, additional resolution is ignored.

The breakpoints should be entered with the sensor units value increasing as point number increases. There should not be any breakpoint locations left blank in the middle of a curve. The search routine in the Model 331 interprets a blank breakpoint as the end of the curve.

5.2 FRONT PANEL CURVE ENTRY OPERATIONS

There are three operations associated with front panel curve entry: Edit curve, Copy curve, Erase curve; as detailed below.

Edit Curve	Edit allows the user to see any curve and enter or edit a curve at any user curve location. Standard curves cannot be changed.	Refer to Paragraph 5.2.1
Erase Curve	Erase allows the user to delete a curve from any user curve location. Standard curves cannot be erased.	Refer to Paragraph 5.2.2
Copy Curve	Copy allows the user to copy a curve from any location to any user curve location. Curves cannot be copied into standard curve locations.	Refer to Paragraph 5.2.3
SoftCal	Allows creation of a new temperature curve from a standard curve and known data points entered by the user.	Refer to Paragraph 5.3

To begin a curve operation, press the **Curve Entry** key and the above selections appear. Press the **Next Setting** key until the desired operation is highlighted and press the **Enter** key. A curve screen appears with the curve number highlighted. Change to the desired curve number with the up or down arrow key, then press the **Enter** key to begin the desired curve operation.

Table 5-1. Curve Header Parameters

Name:	The curve name cannot be changed from the front panel. Curve names can only be entered over the computer interface (up to 15 characters). The default curve name is User xx, where xx is the curve number.			
Serial Num:	Identify specific sensors with serial numbers of up to 10 characters. The serial number field accepts both numbers and letters, but the instrument front panel enters only numbers. To enter both numbers and letters, enter curves over computer interface. The default is blank.			
Curve Format:	The instrument must know the data format of the curve breakpoints. Different sensor types use different data formats. The sensor inputs require one of the formats below. The range and resolution specified are not always available at the same time. Practical range and resolution depend on the sensor type.			
	Format	Description	Sensor Units Full Scale Range	Sensor Units Maximum Resolution
	V/K	Volts vs. Kelvin	10 (V)	0.00001 (V)
	Ω /K	Resistance vs. Kelvin	10 K (Ω)	0.001 (Ω)
	log Ω /K	log Resistance vs. Kelvin	4 (log Ω)	0.00001 (log Ω)
	mV/K	mV vs. Kelvin	\pm 100 (mV)	0.0001 (mV)
SP Limit	A setpoint temperature limit can be included with every curve. When controlling in temperature, the setpoint cannot exceed the limit entered with the curve for the control sensor. The default is 375 K. Set to 9999 K if no limit is required.			
Coeff:	The instrument derives the temperature coefficient from the first two breakpoints. If it is set improperly, check the first two breakpoints. A positive coefficient indicates the sensor signal increases with increasing temperature. A negative coefficient indicates the sensor signal decreases with increasing temperature.			

Table 5-2. Recommended Curve Parameters

Type	Typical Lake Shore Model	Units	Format	Limit (K)	Coefficient	Recommended Sensor Resolution
Silicon Diode	DT-470	Volts	V/K	475	Negative	0.00001 (V)
GaAlAs Diode	TG-120	Volts	V/K	325	Negative	0.00001 (V)
Platinum 100	PT-100	Ohms	Ω /K	800	Positive	0.001 (Ω)
Platinum 1000	PT-100	Ohms	Ω /K	800	Positive	0.01 (Ω)
Rhodium-Iron	RF-100	Ohms	Ω /K	325	Positive	0.001 (Ω)
Carbon-Glass	CGR-1-1000	Ohms	log Ω /K	325	Negative	0.00001 (log Ω)
Cernox	CX-1030	Ohms	log Ω /K	325	Negative	0.00001 (log Ω)
Germanium	GR-200A-100	Ohms	log Ω /K	325	Negative	0.00001 (log Ω)
Rox	RX-102A	Ohms	log Ω /K	40	Negative	0.00001 (log Ω)
Type K	9006-005	mV	mV/K	1500	Positive	0.0001 (mV)
Type E	9006-003	mV	mV/K	930	Positive	0.0001 (mV)
Type T	9006-007	mV	mV/K	673	Positive	0.0001 (mV)
Au-Fe 0.03%	<i>No Longer Sold</i>	mV	mV/K	500	Positive	0.0001 (mV)
Au-Fe 0.07%	9006-001	mV	mV/K	610	Positive	0.0001 (mV)

5.2.1 Edit Curve

The Edit Curve operation is used to enter a new curve or edit an existing user curve. Only user curves (21 to 41) can be changed. Standard curves can only be viewed with the edit operation. Entering the identification parameters associated with the curve is as important as entering the breakpoints. Curve header parameters are listed in Table 5-1. Typical parameters for common sensors are listed in Table 5-2. Read this section completely and gather all necessary data before beginning the process.

NOTE: If the curve you wish to enter has similar parameters to an existing curve, first copy the similar curve (as described in Paragraph 5.2.3) to a new location, then edit the curve to the desired parameters.

To enter a new user curve or edit an existing user curve, press the **Curve Entry** key. Press the **▲** or **▼** key until you see the following display.

```

Select With ▲▼
Edit Curve
    
```

Press the **Enter** key. Press the **Escape** key anytime during this routine to return to the normal display.

```

Select for Edit   ▲▼
Curve 21 User
    
```

Use the **▲** or **▼** key to cycle through the various curves. Curve numbers 21 thru 41 are used to copy or create new curves. You can also view (but not modify) the standard curve numbers 01 thru 20 from here. For this example, we will enter a new curve in location 21. Press the **Enter** key.

```

Enter for Curve 21
Serial # 0123456789
    
```

Use the numerical keypad to enter the applicable sensor serial number; to a maximum of 10 digits. For this example, we will enter 0123456789. Press the **Enter** key.

```

Select for Curv21 ▲▼
Curve Format V/K
    
```

Use the **▲** or **▼** key to cycle through the curve formats: V/K, Ω /K, log Ω /K, mV/K, where V/K = volts per kelvin, Ω /K = ohms per kelvin, log Ω /K = logarithm of the resistance per kelvin, and mV/K = millivolts per kelvin. For this example, we will select V/K. Press the **Enter** key.

```

Enter for Curve 21
SP Limit 475.00k
    
```

Use the numerical keypad to enter a setpoint limit (in kelvin) appropriate for the sensor being used. For this example, we will enter 475.00K. Press the **Enter** key.

```

View for Curve 21
Temp Coeff Positive
    
```

Edit Curve (Continued)

The temperature coefficient (positive or negative) of the curve is displayed. The coefficient is calculated from the first two points of the curve and cannot be changed. Press the **Enter** key.

Now that the curve identification parameters are entered, it is time to enter curve breakpoints.

```
User Curve 21
1: 0.00000v 00.0000k
```

The cursor initially blinks on the curve breakpoint number. When the cursor is in this position, use the **▲** or **▼** key to scroll through the breakpoints in the curve. Press the **Enter** key to modify the current breakpoint. Use the numerical keypad to enter the applicable sensor value. For this example, we will enter 0.09062 V, then press the **Enter** key. The cursor will jump to the temperature reading. Again use numerical keypad to enter the applicable temperature in kelvin. For this example, we will enter 475.0 K. Press the **Enter** key.

```
1: 0.09062v 475.000k
2: 0.00000v 00.0000k
```

Use the numerical keypad to enter the remaining voltage and temperature points. After entering the final point in the curve, press the **Enter** key, then the **Escape** key. You will return to the normal display.

To add a new breakpoint to an existing curve, go to the end of the curve data and enter the new sensor reading and temperature. Press the **Enter** key, then the **Escape** key. The new point is automatically put into its proper place in breakpoint sequence.

NOTE: Typing over an existing reading or temperature will replace that value when you press the **Enter** key.

To delete a breakpoint, go to point and enter all zeros for both the sensor reading and temperature. Press the **Enter** key, then the **Escape** key.

When curve entry is complete, the user must assign the new curve to an input. The Model 331 does not automatically assign the new curve to either input.

5.2.1.1 Thermocouple Curve Considerations

The following are things to consider when generating thermocouple curves.

- Users may enter temperature response curves for all types of thermocouples. Enter curve data in mV/K format with thermocouple voltage in millivolts and temperature in Kelvin.
- The curve must be normalized to 0 mV at 273.15K (0 °C). Thermocouple voltages in millivolts are positive when temperature is above that point and negative when temperature is below that point.
- To convert curves published in Celsius to Kelvin, add 273.15 to the temperature in Celsius.
- The temperature range for some thermocouple types may extend below 1 K or above 1000 K.
- The input voltage of the 331 is limited to ± 50 mV, so any part of the curve that extends beyond ± 50 mV is not usable by the instrument.
- A message of S-OVER or S-UNDER on the display indicates that the measured thermocouple input is over or under the ± 50 mV range.

5.2.2 Erase Curve

User curves that are no longer needed may be erased. Erase Curve sets all identification parameters to default and blanks all breakpoint values.

To erase an existing user curve, press the **Curve Entry** key. Press the ▲ or ▼ key until you see the following display.

```
Select With ▲▼  
Erase Curve
```

Press the **Enter** key. You can press the **Escape** key anytime during this routine to return to the normal display.

```
Select for Erase ▲▼  
Curve 21 User
```

Use the ▲ or ▼ key to cycle through the various user curve numbers 21 thru 41. You cannot erase the standard curve numbers 01 thru 20. Once the user curve number is selected, press the **Enter** key. You will see the following message.

```
Press Esc. to cancel  
or Enter to erase 21
```

Press the **Escape** key to cancel or the **Enter** key to erase the selected user curve. You now return to the normal display.

5.2.3 Copy Curve

Temperature curves can be copied from one location inside the Model 331 to another. This is a good way to make small changes to an existing curve. Curve copy may also be necessary if the user needs the same curve with two different temperature limits or needs to extend the range of a standard curve. The curve that is copied from is always preserved.

NOTE: The copy routine allows you to overwrite an existing user curve. Please ensure the curve number you are writing to is correct before proceeding with curve copy.

To copy a curve, press the **Curve Entry** key. Press the ▲ or ▼ key until you see the following display.

```
Select With ▲▼  
Copy Curve
```

Press the **Enter** key. You can press the **Escape** key anytime during this routine to return to the normal display.

```
Select Copy from ▲▼  
Curve 01 DT-470
```

Use the ▲ or ▼ key to select the curve number (01 thru 41) to copy from.

Copy Curve (Continued)

Once the curve number is selected, press the **Enter** key. You will see the following message.



Use the **▲** or **▼** key to select the curve number (21 thru 41) to copy to. Press the **Enter** key to copy the curve. You now return to the normal display.

5.3 SOFTCAL™

The Model 331 allows the user to perform inexpensive sensor calibrations with a set of algorithms called SoftCal. The two SoftCal algorithms in the Model 331 work with DT-400 Series Silicon Diode sensors and Platinum Sensors. They create a new temperature response curve from the standard curve and known data points entered by the user. The new curve loads into one of the user curve locations (21 thru 41) in the instrument. The following paragraphs describe the data points needed from the user and the expected accuracy of the resulting curves.

Both DT-400 Series and Platinum SoftCal algorithms require a standard curve that is already present in the Model 331. When the user enters the type of sensor being calibrated, the correct standard curve must be selected. When calibration is complete, the user must assign the new curve to an input. The Model 331 does not automatically assign the newly generated curve to either input.

Calibration data points must be entered into the Model 331. These calibration points are normally measured at easily obtained temperatures like the boiling point of cryogenes. Each algorithm operates with one, two, or three calibration points. The range of improved accuracy increases with more points.

There are two ways to get SoftCal calibration data points: ① The user can record the response of an unknown sensor at well controlled temperatures, or ② The user can purchase a SoftCal calibrated sensor from Lake Shore. There are advantages to both methods.

- ① **User:** When the user can provide stable calibration temperatures with the sensor installed, SoftCal calibration eliminates errors in the sensor measurement as well as the sensor. Thermal gradients, instrument accuracy, and other measurement errors can be significant to some users. Calibration can be no better than user-supplied data.
- ② **Purchased:** Lake Shore sensors with SoftCal calibration include a set of calibration points in the calibration report. The SoftCal calibration points are generated in a controlled calibration facility at Lake Shore for best accuracy. The calibration points can be entered into the Model 331 so it can generate a curve. If the CalCurve service is purchased with the calibrated sensor, the curve is also generated at the factory and can be entered like any other curve.

5.3.1 SoftCal With Silicon Diode Sensors

Lake Shore Silicon Diode Sensors incorporate remarkably uniform sensing elements that exhibit precise, monotonic, and repeatable temperature response. For example, the Lake Shore DT-470 Series of silicon diode sensors has a repeatable temperature response from 2 K to 475 K. These sensors closely follow the Standard Curve 10 response and routinely interchange with one another. SoftCal is an inexpensive way to improve the accuracy of an already predictable sensor.

NOTE: Standard Curve 10 is the name of the temperature response curve, not its location inside the Model 331. Standard Curve 10 is stored in Curve Location Number 1 in the Model 331.

A unique characteristic of DT-400 Series diodes is that their temperature responses pass through 28 K at almost exactly the same voltage. This improves SoftCal algorithm operation by providing an extra calibration data point. It also explains why SoftCal calibration specifications are divided into two temperature ranges, above and below 28 K. See Figure 5-1.

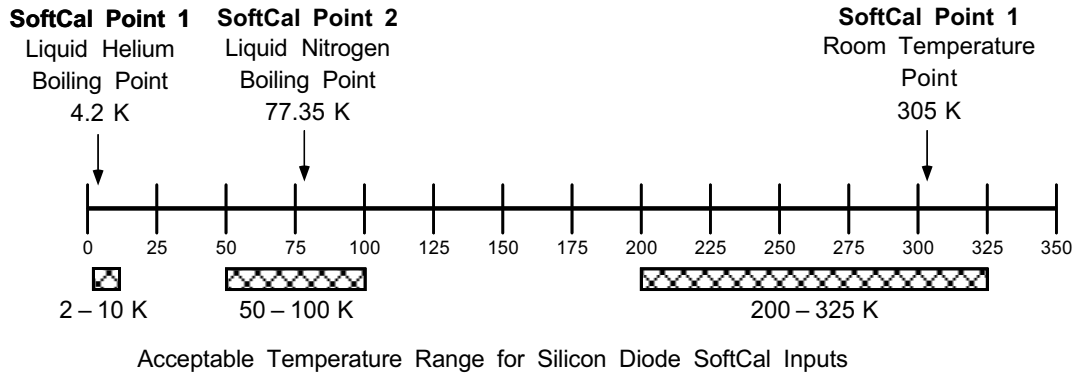

C-331-5-1.eps

Figure 5-1. SoftCal Temperature Ranges for Silicon Diode Sensors

- Point 1:** Calibration data point at or near the boiling point of helium, 4.2 K. Temperatures outside 2 K to 10 K are not allowed. This data point improves between the calibration data point and 28K. Points 2 and 3 improve temperatures above 28 K.
- Point 2:** Calibration data point at or near the boiling point of nitrogen (77.35 K). Temperatures outside 50 K to 100 K are not allowed. This data point improves accuracy between 28 K and 100 K. Points 2 and 3, together, improve accuracy to room temperature and above.
- Point 3:** Calibration data point near room temperature (305 K). Temperatures outside the range of 200 K to 350 K are not allowed.

5.3.2 SoftCal Accuracy With Silicon Diode Sensors

A SoftCal calibration is only as good as the accuracy of the calibration points. The accuracies listed for SoftCal assume ± 0.01 K for 4.2 K (liquid helium), ± 0.05 K for 77.35 K (liquid nitrogen), and 305 K (room temperature) points. Users performing the SoftCal with Lake Shore instruments should note that the boiling point of liquid cryogen, though accurate, is affected by atmospheric pressure. Use calibrated standard sensors if possible.

One-point SoftCal calibrations for applications under 30 K are performed at liquid helium (4.2 K) temperature. Accuracy for the DT-470-SD-13 diode is ± 0.5 K from 2 K to <30 K with no accuracy change above 30 K.

Two-point SoftCal calibrations for applications above 30 K are performed at liquid nitrogen (77.35 K) and room temperature (305 K). Accuracy for the DT-470-SD-13 diode sensor is as follows:

- ± 1.0 K 2 K to <30 K (no change below 30 K)
- ± 0.25 K 30 K to <60 K
- ± 0.15 K 60 K to <345 K
- ± 0.25 K 345 K to <375 K
- ± 1.0 K 375 to 475 K

Three-point SoftCal calibrations are performed at liquid helium (4.2 K), liquid nitrogen (77.35 K), and room temperature (305 K). Accuracy for the DT-470-SD-13 diode sensor is as follows:

- ± 0.5 K 2 K to <30
- ± 0.25 K 30 K to <60 K
- ± 0.15 K 60 K to <345 K
- ± 0.25 K 345 K to <375 K
- ± 1.0 K 375 to 475 K

5.3.3 SoftCal With Platinum Sensors

The platinum sensor is a well-accepted temperature standard because of its consistent and repeatable temperature response above 30 K. SoftCal gives platinum sensors better accuracy than their nominal matching to the DIN 43760 curve.

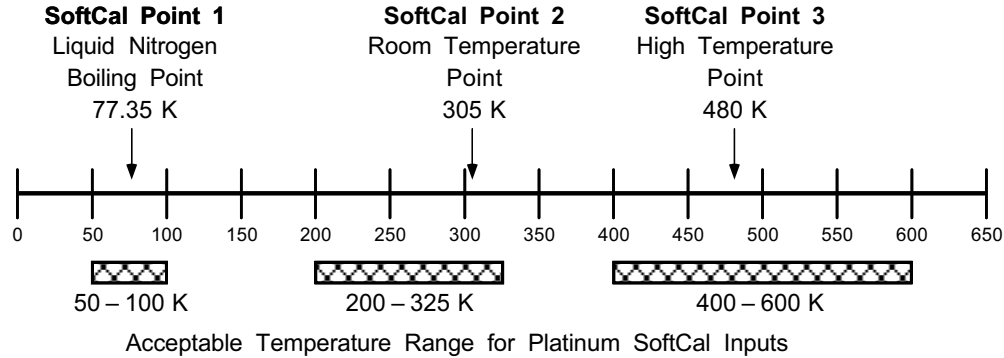

C-331-5-2.eps

Figure 5-2. SoftCal Temperature Ranges for Platinum Sensors

One, two, or three calibration data points can be used. If using one point, the algorithm shifts the entire curve up or down to meet the single point. If using two points, the algorithm has enough information to tilt the curve, achieving good accuracy between the data points. The third point extends the improved accuracy to span all three points.

- Point 1:** Calibration data point at or near the boiling point of nitrogen (77.35 K). Temperatures outside 50 K to 100 K are not allowed.
- Point 2:** Calibration data point near room temperature (305 K). Temperatures outside 200 K to 350 K are not allowed.
- Point 3:** Calibration data point at a higher temperature (480 K). Temperatures outside 400 K to 600 K are not allowed.

5.3.4 SoftCal Accuracy With Platinum Sensors

A SoftCal calibration is only as good as the accuracy of the calibration points. The accuracies listed for SoftCal assume ± 0.05 K for 77.35 K (liquid nitrogen) and 305 K (room temperature) points. Users performing the SoftCal with Lake Shore instruments should note that the boiling point of liquid cryogen, though accurate, is affected by atmospheric pressure. Use calibrated standard sensors if possible.

One-point SoftCal calibrations with platinum sensors have no specified accuracy.

Two-point SoftCal calibrations for applications above 70 K are performed at liquid nitrogen (77.35 K) and room temperature (305 K). Accuracy for the PT-102, PT-103, or PT-111 platinum sensor is as follows:

- ± 250 mK from 70 K to 325 K
- $\approx \pm 500$ mK from 325 K to $\approx \pm 1400$ mK at 480 K
- (DIN Class A or Class B tolerance)

Three-point SoftCal calibrations are performed at liquid nitrogen (77.35 K), room temperature (305 K), and high temperature (480 K). Accuracy for the PT-102, PT-103, or PT-111 platinum sensor is ± 250 mK from 70 K to 325 K, and ± 250 mK from 325 K to 480 K.

5.3.5 SoftCal Calibration Curve Creation

Once the calibration data points have been obtained, you may create a SoftCal calibration. This example illustrates SoftCal of a DT-470 Diode. Press the **Curve Entry** key. Press the **▲** or **▼** key until you see the following display.

```
Select With ▲▼
SoftCal
```

Press the **Enter** key. You can press the **Escape** key anytime during this routine to return to the normal display.

```
Select for Scal ▲▼
DT-470
```

Use the **▲** or **▼** key to cycle through the sensor type you wish to SoftCal: DT-470, PT-100, and PT-1000. Once the sensor type is selected, press the **Enter** key. You will see the following message.

```
Select Write to ▲▼
Curve 21 User
```

NOTE: The copy routine allows you to overwrite an existing user curve. Please ensure the curve number you are writing to is correct before proceeding with curve copy.

Use the **▲** or **▼** key to select the user curve location where the SoftCal curve will be stored. You can choose any of the user curve locations, 21 thru 41. Press the **Enter** key. You will see the following message.

```
Serial #
0123456789
```

Use the numerical keypad to enter the applicable sensor serial number; to a maximum of 10 digits. For this example, we will enter 0123456789. Press the **Enter** key.

```
Point 1
+1.62999v 04.1800k
```

NOTE: If Point 1 is not being used, press the **Enter** key with both settings at their default value and advance to Point 2.

Use the numerical keypad to enter the measured data point at or near the boiling point of helium (4.2 K). Temperatures outside the range of 2–10 K are not permitted. The message “Invalid Point. Please Reenter” is displayed if either point is outside the acceptable range. For this example, we will enter 1.62999. Press the **Enter** key. The cursor will jump to the temperature reading. Again use numerical keypad to enter the temperature the measurement was taken at. For this example, we will enter 4.18 K. Press the **Enter** key.

```
Point 2
+1.02111v 77.0000k
```

SoftCal Calibration Curve Creation (Continued)

NOTE: If Point 2 is not being used, press the **Enter** key with both settings at their default value and advance to Point 3.

Use the numerical keypad to enter the measured data point at or near the boiling point of nitrogen (77.35 K). Temperatures outside the range of 50–100 K are not permitted. For this example, we will enter 1.02111. Press the **Enter** key. The cursor will jump to the temperature reading. Again use numerical keypad to enter the temperature the measurement was taken at. For this example, we will enter 77 K. Press the **Enter** key.

Point 3
+0.51583v 302.500k

NOTE: If Point 3 is not being used, press the **Enter** key with both settings at their default value to complete the SoftCal calibration.

Use the numerical keypad to enter the measured data point at or near room temperature (305 K). Temperatures outside the range of 200–350 K are not permitted. For this example, we will enter 0.51583. Press the **Enter** key. The cursor will jump to the temperature reading. Again use numerical keypad to enter the temperature the measurement was taken at. For this example, we will enter 302.5 K. Press the **Enter** key.

The new curve is automatically generated and you will return to the normal display. You can check the new curve using the Edit Curve instructions in Paragraph 5.2.1. The curve is not automatically assigned to either input, so the new curve must be assigned to an input by the user.

This Page Intentionally Left Blank

CHAPTER 6

COMPUTER INTERFACE OPERATION

6.0 GENERAL

This chapter provides operational instructions for the computer interface for the Lake Shore Model 331 Temperature Controller. Either of the two computer interfaces provided with the Model 331 permit remote operation. The first is the IEEE-488 Interface described in Paragraph 6.1. The second is the Serial Interface described in Paragraph 6.2. The two interfaces share a common set of commands detailed in Paragraph 6.3. Only one of the interfaces can be used at a time.

NOTE: The remote interface of the Model 331 can be set to emulate a Lake Shore Model 330 Temperature Controller. Refer to Paragraph 4.20 to select 330 Emulation Mode. Refer to your Model 330 User's Manual for command syntax. The following Model 330 commands are not supported in 330 Emulation Mode: CUID?, CURV, CURV?, ECUR, KCUR, and SCAL.

6.1 IEEE-488 INTERFACE (Model 331S Only)

The IEEE-488 Interface is an instrumentation bus with hardware and programming standards that simplify instrument interfacing. The Model 331 IEEE-488 Interface complies with the IEEE-488.2-1987 standard and incorporates its functional, electrical, and mechanical specifications unless otherwise specified in this manual.

All instruments on the interface bus perform one or more of the interface functions of TALKER, LISTENER, or BUS CONTROLLER. A TALKER transmits data onto the bus to other devices. A LISTENER receives data from other devices through the bus. The BUS CONTROLLER designates to the devices on the bus which function to perform. The Model 331 performs the functions of TALKER and LISTENER but cannot be a BUS CONTROLLER. The BUS CONTROLLER is the digital computer which tells the Model 331 which functions to perform.

Below are Model 331 IEEE-488 interface capabilities:

- **SH1:** Source handshake capability.
- **RL1:** Complete remote/local capability.
- **DC1:** Full device clear capability.
- **DT0:** No device trigger capability.
- **C0:** No system controller capability.
- **T5:** Basic TALKER, serial poll capability, talk only, unaddressed to talk if addressed to listen.
- **L4:** Basic LISTENER, unaddressed to listen if addressed to talk.
- **SR1:** Service request capability.
- **AH1:** Acceptor handshake capability.
- **PP0:** No parallel poll capability.
- **E1:** Open collector electronics.

NOTE: The Model 331 IEEE-488 Interface requires that repeat addressing be enabled on the bus controller.

Instruments are connected to the IEEE-488 bus by a 24-conductor connector cable as specified by the standard. Refer to Paragraph 8.4.2. Cables can be purchased from Lake Shore or other electronic suppliers. A connector extender (Model 4005) is required to use the IEEE-488 Interface and the RELAY and ANALOG OUTPUT Terminal Block at the same time.

Cable lengths are limited to 2 meters for each device and 20 meters for the entire bus. The Model 331 can drive a bus with up to 10 loads. If more instruments or cable length is required, a bus expander must be used.

6.1.1 Changing IEEE-488 Interface Parameters

Two interface parameters, address and terminators, must be set from the front panel before communication with the instrument can be established. Other interface parameters can be set with device specific commands using the interface (Paragraph 6.3).

Press the **Interface** key. The first screen is for selecting the Serial Interface Baud Rate, and can be skipped by pressing the **Enter** key. The Address screen is then displayed as follows.

```
Select With ▲▼
IEEE Address 12
```

Press the **▲** or **▼** keys to increment or decrement the IEEE Address to the desired number. Valid addresses are 1 thru 30. Default is 12. Press **Enter** to accept new number or **Escape** to retain the existing number. Pressing **Enter** displays the Terminators screen.

```
Select With ▲▼
IEEE Term Cr Lf
```

Press the **▲** or **▼** keys to cycle through the following Terminator choices: CR/LF, LF/CR, LF, and EOI. The default is Cr Lf. To accept changes or the currently displayed setting, push **Enter**. To cancel changes, push **Escape**.

6.1.2 IEEE-488 Command Structure

The Model 331 supports several command types. These commands are divided into three groups.

1. **Bus Control** – Refer to Paragraph 6.1.2.1.
 - a. Universal
 - (1) Uniline
 - (2) Multiline
 - b. Addressed Bus Control
2. **Common** – Refer to Paragraph 6.1.2.2.
3. **Device Specific** – Refer to Paragraph 6.1.2.3.
4. **Message Strings** – Refer to Paragraph 6.1.2.4.

6.1.2.1 Bus Control Commands

A Universal Command addresses all devices on the bus. Universal Commands include Uniline and Multiline Commands. A Uniline Command (Message) asserts only a single signal line. The Model 331 recognizes two of these messages from the BUS CONTROLLER: **Remote (REN)** and **Interface Clear (IFC)**. The Model 331 sends one Uniline Command: **Service Request (SRQ)**.

REN (Remote) – Puts the Model 331 into remote mode.

IFC (Interface Clear) – Stops current operation on the bus.

SRQ (Service Request) – Tells the bus controller that the Model 331 needs interface service.

A Multiline Command asserts a group of signal lines. All devices equipped to implement such commands do so simultaneously upon command transmission. These commands transmit with the Attention (ATN) line asserted low. The Model 331 recognizes two Multiline commands:

LLO (Local Lockout) – Prevents the use of instrument front panel controls.

DCL (Device Clear) – Clears Model 331 interface activity and puts it into a bus idle state.

Bus Control Commands (Continued)

Finally, Addressed Bus Control Commands are Multiline commands that must include the Model 331 listen address before the instrument responds. Only the addressed device responds to these commands. The Model 331 recognizes three of the Addressed Bus Control Commands:

SDC (Selective Device Clear) – The SDC command performs essentially the same function as the DCL command except that only the addressed device responds.

GTL (Go To Local) – The GTL command is used to remove instruments from the remote mode. With some instruments, GTL also unlocks front panel controls if they were previously locked out with the LLO command.

SPE (Serial Poll Enable) and **SPD (Serial Poll Disable)** – Serial polling accesses the Service Request Status Byte Register. This status register contains important operational information from the unit requesting service. The SPD command ends the polling sequence.

6.1.2.2 Common Commands

Common Commands are addressed commands which create commonality between instruments on the bus. All instruments that comply with the IEEE-488 1987 standard share these commands and their format. Common commands all begin with an asterisk. They generally relate to “bus” and “instrument” status and identification. Common query commands end with a question mark (?). Model 331 common commands are detailed in Paragraph 6.3 and summarized in Table 6-8.

6.1.2.3 Device Specific Commands

Device specific commands are addressed commands. The Model 331 supports a variety of device specific commands to program instruments remotely from a digital computer and to transfer measurements to the computer. Most device specific commands perform functions also performed from the front panel. Model 331 device specific commands are detailed in Paragraph 6.3 and summarized in Table 6-8.

6.1.2.4 Message Strings

A message string is a group of characters assembled to perform an interface function. There are three types of message strings commands, queries and responses. The computer issues command and query strings through user programs, the instrument issues responses. Two or more command strings can be chained together in one communication but they must be separated by a semi-colon (;). Only one query is permitted per communication but it can be chained to the end of a command. The total communication string must not exceed 64 characters in length.

A command string is issued by the computer and instructs the instrument to perform a function or change a parameter setting. When a command is issued, the computer is acting as 'talker' and the instrument as 'listener'. The format is:

```
<command mnemonic><space><parameter data><terminators>.
```

Command mnemonics and parameter data necessary for each one is described in Paragraph 6.3. Terminators must be sent with every message string.

A query string is issued by the computer and instructs the instrument which response to send. Queries are issued similar to commands with the computer acting as 'talker' and the instrument as 'listener'. The query format is:

```
<query mnemonic><?><space><parameter data><terminators>.
```

Query mnemonics are often the same as commands with the addition of a question mark. Parameter data is often unnecessary when sending queries. Query mnemonics and parameter data if necessary is described in Paragraph 6.3. Terminators must be sent with every message string. Issuing a query does not initiate a response from the instrument.

A response string is sent by the instrument only when it is addressed as a 'talker' and the computer becomes the 'listener'. The instrument will respond only to the last query it receives. The response can be a reading value, status report or the present value of a parameter. Response data formats are listed along with the associated queries in Paragraph 6.3.

6.1.3 Status Registers

There are two status registers: the Status Byte Register described in Paragraph 6.1.3.1, and the Standard Event Status Register in Paragraph 6.1.3.2.

6.1.3.1 Status Byte Register and Service Request Enable Register

The Status Byte Register contains six bits of information about the operation of the Model 331.

STATUS BYTE REGISTER FORMAT

Bit –	7	6	5	4	3	2	1	0
Weighting –	128	64	32	16	8	4	2	1
Bit Name –	Ramp Done	SRQ	ESB	Error	Alarm	Not Used	Not Used	New A&B

If Service Request is enabled, any of these bits being set will cause the Model 331 to pull the SRQ management line low to signal the BUS CONTROLLER. These bits are reset to zero upon a serial poll of the Status Byte Register. These reports can be inhibited by turning their corresponding bits in the Service Request Enable Register to off.

The Service Request Enable Register allows the user to inhibit or enable any of the status reports in the Status Byte Register. The *SRE command is used to set the bits. If a bit in the Service Request Enable Register is set (1), then that function is enabled. Refer to the *SRE command discussion.

Ramp Done, Bit (7) – This bit is set when the ramp is completed.

Service Request (SRQ) Bit (6) – Determines whether the Model 331 is to report via the SRQ line. If bits 0, 3, 4, 5 and/or 7 are set, then the corresponding bit in the Status Byte Register will be set. The Model 331 will produce a service request only if bit 6 of the Service Request Enable Register is set. If disabled, the Status Byte Register can still be read by the BUS CONTROLLER by means of a serial poll (SPE) to examine the status reports, but the BUS CONTROLLER will not be interrupted by the Service Request. The *STB common command will read the Status Byte Register but will not clear the bits.

Standard Event Status (ESB), Bit (5) – When bit 5 is set, it indicates if one of the bits from the Standard Event Status Register has been set. (Refer to Paragraph 6.1.3.2.)

Error, Bit (4) – This bit is set when there is an instrument error not related to the bus.

Alarm, Bit (3) – This bit is set when there is an alarm condition.

New A&B, Bit (0) – This bit is set when new data is available from the normal inputs.

6.1.3.2 Standard Event Status Register and Standard Event Status Enable Register

The Standard Event Status Register reports IEEE bus status of the Model 331.

STANDARD EVENT STATUS REGISTER FORMAT

Bit –	7	6	5	4	3	2	1	0
Weighting –	128	64	32	16	8	4	2	1
Bit Name –	PON	Not Used	CME	EXE	DDE	QYE	Not Used	OPC

Bits 2 and 6 are not used. The bus controller will only be interrupted with the reports of this register if the bits have been enabled in the Standard Event Status Enable Register and if bit 5 of the Service Request Enable Register has been set.

The Standard Event Status Enable Register allows the user to enable any of the Standard Event Status Register reports. The Standard Event Status Enable command (*ESE) sets the Standard Event Status Enable Register bits. If a bit of this register is set, then that function is enabled. To set a bit, send the command *ESE with the bit weighting for each bit you want to be set added together. See the *ESE command discussion for further details.

Standard Event Status Register and Standard Event Status Enable Register (Continued)

The Standard Event Status Enable Query, *ESE?, reads the Standard Event Status Enable Register. *ESR? reads the Standard Event Status Register. Once this register has been read, all of the bits are reset to zero.

Power On (PON), Bit (7) – This bit is set to indicate an instrument off-on transition.

Command Error (CME), Bit (5) – This bit is set if a command error has been detected since the last reading. This means that the instrument could not interpret the command due to a syntax error, an unrecognized header, unrecognized terminators, or an unsupported command.

Execution Error (EXE), Bit (4) – This bit is set if the EXE bit is set, an execution error has been detected. This occurs when the instrument is instructed to do something not within its capabilities.

Device Dependent Error (DDE), Bit (3) – This bit is set if a device dependent error has been detected if the DDE bit is set. The actual device dependent error can be found by executing the various device dependent queries.

Query Error (QYE), Bit (2) – This bit indicates a query error. It occurs rarely and involves loss of data because the output queue is full.

Operation Complete (OPC), Bit (0) – This bit is generated in response to the *OPC common command. It indicates when the Model 331 has completed all selected pending operations. It is not related to the *OPC? command, which is a separate interface feature.

6.1.4 IEEE Interface Example Programs

Two BASIC programs are included to illustrate the IEEE-488 communication functions of the instrument. The first program was written in Visual Basic. Refer to Paragraph 6.1.4.1 for instructions on how to setup the program. The Visual Basic code is provided in Table 6-2. The second program is written in Quick Basic. Refer to Paragraph 6.1.4.3 for instructions on how to setup the program. The Quick Basic code is provided in Table 6-3. Finally, a description of operation common to both programs is provided in Paragraph 6.1.4.5. While the hardware and software required to produce and implement these programs not included with the instrument, the concepts illustrated apply to almost any application where these tools are available.

6.1.4.1 IEEE-488 Interface Board Installation for Visual Basic Program

This procedure works for Plug and Play GPIB Hardware and Software for Windows 98/95. This example uses the AT-GPIB/TNT GPIB card.

1. Install the GPIB Plug and Play Software and Hardware using National Instruments instructions.
2. Verify that the following files have been installed to the Windows System folder:
 - a. gpib-32.dll
 - b. gpib.dll
 - c. gpib32ft.dll

Files b and c will support 16-bit Windows GPIB applications if any are being used.
3. Locate the following files and make note of their location. These files will be used during the development process of a Visual Basic program.
 - a. Niglobal.bas
 - b. Vbib-32.bas

NOTE: If the files in Steps 2 and 3 are not installed on your computer, they may be copied from your National Instruments setup disks or they may be downloaded from www.natinst.com.

4. Configure the GPIB by selecting the System icon in the Windows 98/95 Control Panel located under Settings on the Start Menu. Configure the GPIB Settings as shown in Figure 6-1. Configure the DEV12 Device Template as shown in Figure 6-2. Be sure to check the Readdress box.

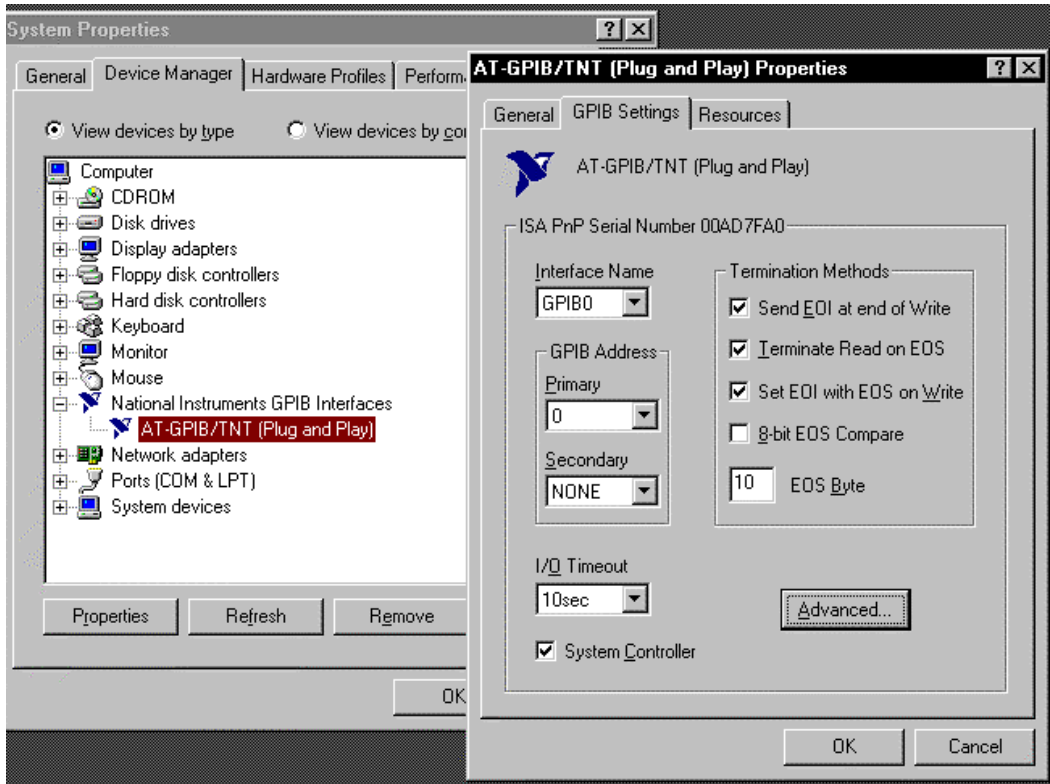

Figure 6-1. GPIB Setting Configuration

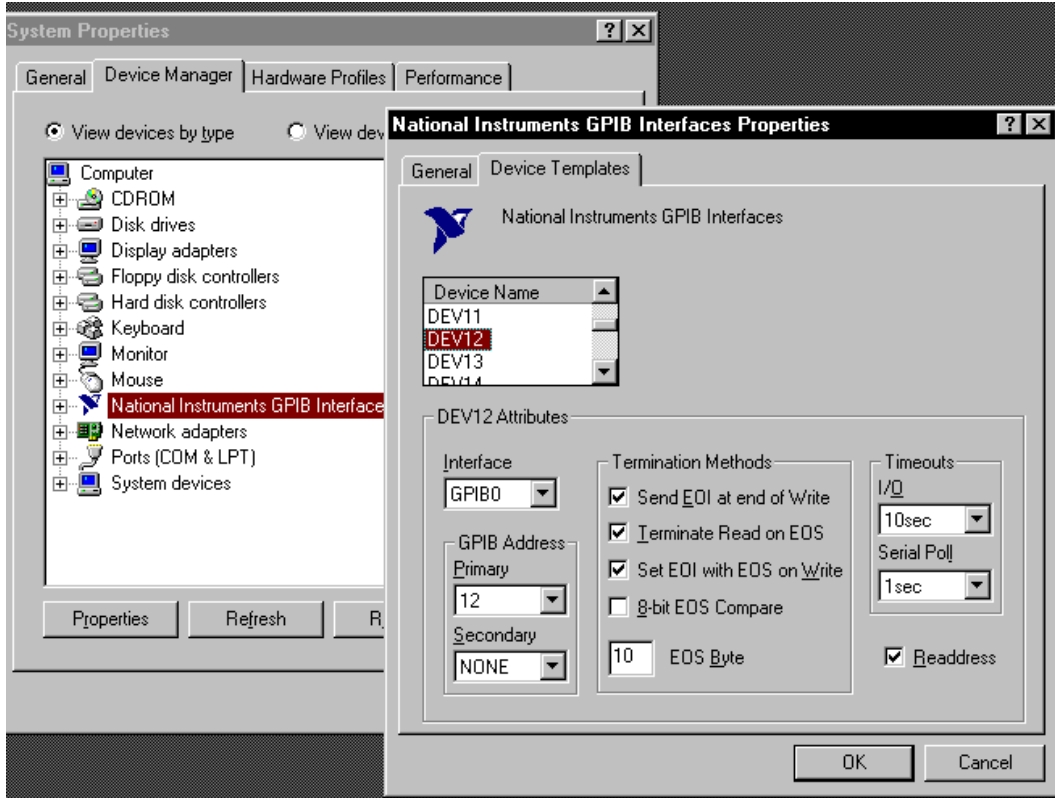
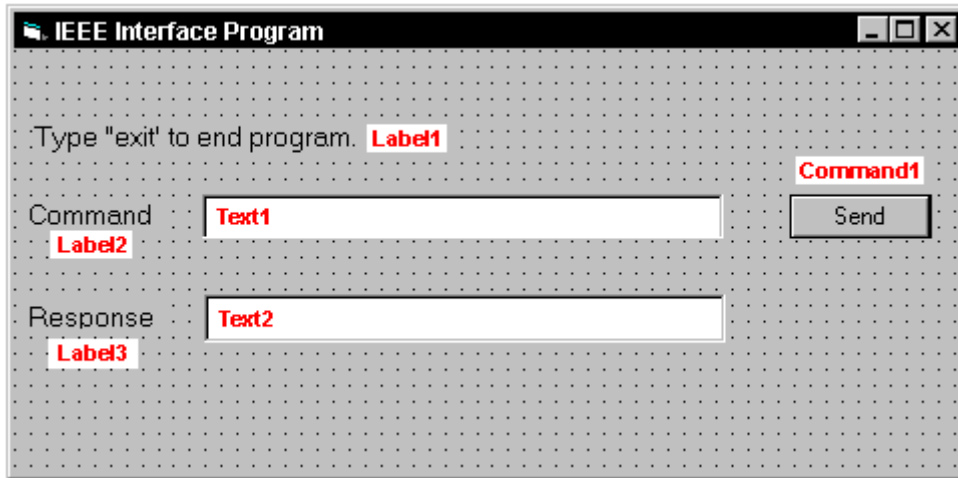

Figure 6-2. DEV 12 Device Template Configuration

6.1.4.2 Visual Basic IEEE-488 Interface Program Setup

This IEEE-488 interface program works with Visual Basic 6.0 (VB6) on an IBM PC (or compatible) with a Pentium-class processor. A Pentium 90 or higher is recommended, running Windows 95 or better. It assumes your IEEE-488 (GPIB) card is installed and operating correctly (refer to Paragraph 6.1.4.1). Use the following procedure to develop the IEEE-488 Interface Program in Visual Basic.

1. Start VB6.
2. Choose Standard EXE and select Open.
3. Resize form window to desired size.
4. On the Project Menu, select Add Module, select the Existing tab, then navigate to the location on your computer to add the following files: Niglobal.bas and Vbib-32.bas.
5. Add controls to form:
 - a. Add three Label controls to the form.
 - b. Add two TextBox controls to the form.
 - c. Add one CommandButton control to the form.
6. On the View Menu, select Properties Window.
7. In the Properties window, use the dropdown list to select between the different controls of the current project.



10. Set the properties of the controls as defined in Table 6-1.
11. Save the program.

Table 6-1. IEEE-488 Interface Program Control Properties

Current Name	Property	New Value
Label1	Name Caption	lblExitProgram Type "exit" to end program.
Label2	Name Caption	lblCommand Command
Label3	Name Caption	lblResponse Response
Text1	Name Text	txtCommand <blank>
Text2	Name Text	txtResponse <blank>
Command1	Name Caption Default	cmdSend Send True
Form1	Name Caption	frmIEEE IEEE Interface Program

12. Add code (provided in Table 6-2).
 - a. In the Code Editor window, under the Object dropdown list, select (General). Add the statement: Public gSend as Boolean
 - b. Double Click on cmdSend. Add code segment under Private Sub cmdSend_Click() as shown in Table 6-2.
 - c. In the Code Editor window, under the Object dropdown list, select Form. Make sure the Procedure dropdown list is set at Load. The Code window should have written the segment of code: Private Sub Form_Load(). Add the code to this subroutine as shown in Table 6-2.
13. Save the program.
14. Run the program. The program should resemble the following.

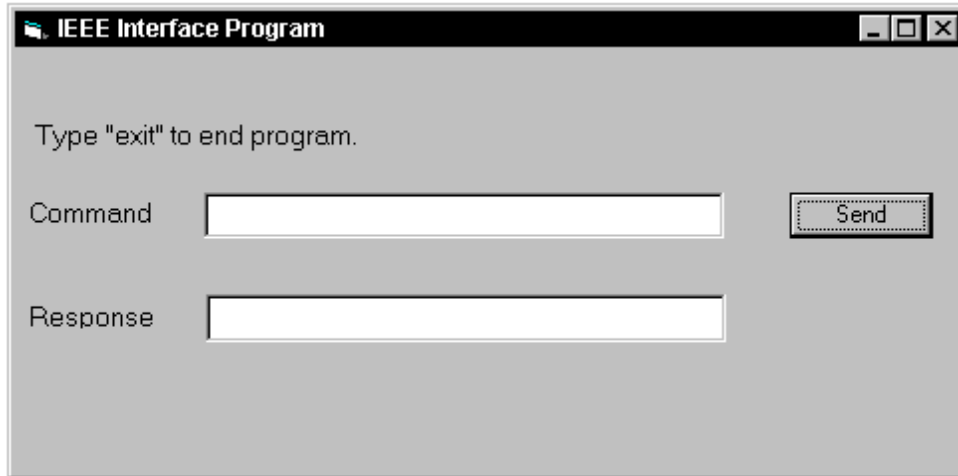

15. Type in a command or query in the Command box as described in Paragraph 6.1.4.5.
16. Press Enter or select the Send button with the mouse to send command.
17. Type Exit and press Enter to quit.

Table 6-2. Visual Basic IEEE-488 Interface Program

Public gSend As Boolean	'Global used for Send button state
Private Sub cmdSend_Click() gSend = True	'Routine to handle Send button press 'Set Flag to True
End Sub	
Private Sub Form_Load() Dim strReturn As String Dim term As String Dim strCommand As String Dim intDevice As Integer frmIEEE.Show term = Chr(13) & Chr(10) strReturn = "" Call ibdev(0, 12, 0, T10s, 1, &H140A, intDevice) Do Do DoEvents Loop Until gSend = True gSend = False strCommand = frmIEEE.txtCommand.Text strReturn = "" strCommand = UCase(strCommand) If strCommand = "EXIT" Then End End If Call ibwrt(intDevice, strCommand & term) If (ibsta And EERR) Then 'do error handling if needed End If If InStr(strCommand, "?") <> 0 Then strReturn = Space(100) Call ibrd(intDevice, strReturn) If (ibsta And EERR) Then 'do error handling if needed End If If strReturn <> "" Then strReturn = RTrim(strReturn) Do While Right(strReturn, 1) = Chr(10) Or Right(strReturn, 1) = Chr(13) strReturn = Left(strReturn, Len(strReturn) - 1) Loop Else strReturn = "No Response" End If frmIEEE.txtResponse.Text = strReturn End If Loop End Sub	'Main code section 'Used to return response 'Terminators 'Data string sent to instrument 'Device number used with IEEE 'Show main window 'Terminators are <CR><LF> 'Clear return string 'Initialize the IEEE device 'Wait loop 'Give up processor to other events 'Loop until Send button pressed 'Set Flag as False 'Get Command 'Clear response display 'Set all characters to upper case 'Get out on EXIT 'Send command to instrument 'Check for IEEE errors 'Handle errors here 'Check to see if query 'Build empty return buffer 'Read back response 'Check for IEEE errors 'Handle errors here 'Check if empty string 'Remove extra spaces and Terminators 'Send No Response 'Put response in text on main form

6.1.4.3 IEEE-488 Interface Board Installation for Quick Basic Program

This procedure works on an IBM PC (or compatible) running DOS or in a DOS window. This example uses the National Instruments GPIB-PCII/IIA card.

1. Install GPIB-PCII/IIA card using National Instruments instructions.
2. Install NI-488.2 software (for DOS). Version 2.1.1 was used for the example.
3. Verify that config.sys contains the command: device = \gpib-pc\gpib.com.
4. Reboot the computer.
5. Run IBTEST to test software configuration. Do not install the instrument before running IBTEST.
6. Run IBCONF to configure the GPIB – PCII/IIA board and dev 12. Set the EOS byte to 0AH and Enable Repeat Addressing to Yes. See Figure 6-3. IBCONF modifies gpib.com.
7. Connect the instrument to the interface board and power up the instrument. Verify the address is 12 and terminators are CR LF.

6.1.4.4 Quick Basic Program

The IEEE-488 interface program in Table 6-3 works with QuickBasic 4.0/4.5 or Qbasic on an IBM PC (or compatible) running DOS or in a DOS window. It assumes your IEEE-488 (GPIB) card is installed and operating correctly (refer to Paragraph 6.1.4.3). Use the following procedure to develop the Serial Interface Program in Quick Basic.

1. Copy c:\gpib-pc\Qbasic\qbib.obj to the QuickBasic directory (QB4).
2. Change to the QuickBasic directory and type: link /q qbib.obj,,,bqlb4x.lib; where x = 0 for QB4.0 and 5 for QB4.5 This one-time only command produces the library file qbib.qlb. The procedure is found in the National Instruments QuickBasic readme file Readme.qb.
3. Start QuickBasic. Type: qb /l qbib.qlb. Start QuickBasic in this way each time the IEEE interface is used to link in the library file.
4. Create the IEEE example interface program in QuickBasic. Enter the program exactly as presented in Table 6-3. Name the file "ieeexam.bas" and save.
5. Run the program.
6. Type a command query as described in Paragraph 6.1.4.5.
7. Type "EXIT" to quit the program.

National Instruments	GPIB0 Configuration	GPIB-PC2/2A Ver 2.1
Primary GPIB Address →0	↑ █ ↓	Select the primary GPIB address by using the left and right arrow keys.
Secondary GPIB Address NONE		This address is used to compute the talk and listen addresses which identify the board or device on the GPIB. Valid primary addresses range from 0 to 30 (00H to 1EH).
Timeout setting 10sec		* Adding 32 to the primary address forms the Listen Address (LA).
Terminate Read on EOS Yes		* Adding 64 to the primary address forms the Talk Address (TA).
Set EOI with EOS on Writes .. Yes		EXAMPLE: Selecting a primary address of 10 yields the following:
Type of compare on EOS 7-Bit		10 + 32 = 42 (Listen address)
EOS byte 0Ah		10 + 64 = 74 (Talk address)
Send EOI at end of Write Yes		
System Controller Yes		
Assert REN when SC No		
Enable Auto Serial Polling .. No		
Enable CIC Protocol No		
Bus Timing 500nsec		
Parallel Poll Duration Default		
Use this GPIB board Yes		
Board Type PCII		
Base I/O Address 02B8h		
F1: Help F6: Reset Value F9/Esc: Return to Map Ctl PgUp/PgDn: Next/Prev Board		

National Instruments	DEV12 Configuration	GPIB-PC2/2A Ver 2.1
Primary GPIB Address →12	↑ █ ↓	Select the primary GPIB address by using the left and right arrow keys.
Secondary GPIB Address NONE		This address is used to compute the talk and listen addresses which identify the board or device on the GPIB. Valid primary addresses range from 0 to 30 (00H to 1EH).
Timeout setting 10sec		* Adding 32 to the primary address forms the Listen Address (LA).
Serial Poll Timeout 1sec		* Adding 64 to the primary address forms the Talk Address (TA).
Terminate Read on EOS Yes		EXAMPLE: Selecting a primary address of 10 yields the following:
Set EOI with EOS on Writes .. Yes		10 + 32 = 42 (Listen address)
Type of compare on EOS 7-Bit		10 + 64 = 74 (Talk address)
EOS byte 0Ah		
Send EOI at end of Write Yes		
Enable Repeat Addressing Yes		
F1: Help F6: Reset Value F9/Esc: Return to Map Ctl PgUp/PgDn: Next/Prev Board		

C-331-6-3.eps

Figure 6-3. Typical National Instruments GPIB Configuration from IBCONF.EXE

Table 6-3. Quick Basic IEEE-488 Interface Program

```

'      IEEEEXAM.BAS      EXAMPLE PROGRAM FOR IEEE-488 INTERFACE
'
'      This program works with QuickBasic 4.0/4.5 on an IBM PC or compatible.
'
'      The example requires a properly configured National Instruments GPIB-PC2 card. The REM
'      $INCLUDE statement is necessary along with a correct path to the file QBDECL.BAS.
'      CONFIG.SYS must call GPIB.COM created by IBCONF.EXE prior to running Basic. There must
'      be QBIB.QBL library in the QuickBasic Directory and QuickBasic must start with a link
'      to it. All instrument settings are assumed to be defaults: Address 12, Terminators
'      <CR> <LF> and EOI active.
'
'      To use, type an instrument command or query at the prompt. The computer transmits to
'      the instrument and displays any response. If no query is sent, the instrument responds
'      to the last query received. Type "EXIT" to exit the program.
'
'      REM $INCLUDE: 'c:\gpib-pc\qbasic\qbdecl.bas'      'Link to IEEE calls
'      CLS                                              'Clear screen
'      PRINT "IEEE-488 COMMUNICATION PROGRAM"
'      PRINT
'
'      CALL IBFIND("dev12", DEV12%)                    'Open communication at address 12
'      TERM$ = CHR$(13) + CHR$(10)                    'Terminators are <CR><LF>
'
LOOP2: IN$ = SPACE$(2000)                              'Clear for return string
'
'      LINE INPUT "ENTER COMMAND (or EXIT):"; CMD$    'Get command from keyboard
'      CMD$ = UCASE$(CMD$)                             'Change input to upper case
'      IF CMD$ = "EXIT" THEN END                       'Get out on Exit
'      CMD$ = CMD$ + TERM$
'
'      CALL IBWRT(DEV12%, CMD$)                       'Send command to instrument
'
'      CALL IBRD(DEV12%, IN$)                          'Get data back each time
'
'      ENDTEST = INSTR(IN$, CHR$(13))                 'Test for returned string
'      IF ENDTEST > 0 THEN                             'String is present if <CR> is seen
'          IN$ = MID$(IN$, 1, ENDTEST - 1)            'Strip off terminators
'          PRINT "RESPONSE:", IN$                    'Print return string
'      ELSE
'          PRINT "NO RESPONSE"                       'No string present if timeout
'      END IF
'      GOTO LOOP2                                     'Get next command

```

6.1.4.5 Program Operation

Once either example program is running, try the following commands and observe the response of the instrument. Input from the user is shown in **bold** and terminators are added by the program. The word [term] indicates the required terminators included with the response.

<p>ENTER COMMAND? *IDN?</p> <p>RESPONSE: LSCI,MODEL331S,123456,020300 [term]</p>	<p>Identification query. Instrument will return a string identifying itself.</p>
<p>ENTER COMMAND? KRDG?</p> <p>RESPONSE: +273.15 [term]</p>	<p>Temperature reading in kelvin query. Instrument will return a string with the present temperature reading.</p>
<p>ENTER COMMAND? RANGE 0</p> <p>ENTER COMMAND? RANGE?</p> <p>RESPONSE: 0 [term]</p>	<p>Heater range command. Instrument will turn off the heater. No response will be sent.</p> <p>Heater range query. Instrument will return a string with the present heater range setting.</p>
<p>ENTER COMMAND? RANGE 1;RANGE?</p> <p>RESPONSE: 1 [term]</p>	<p>Heater range command followed by a query. Instrument will change to heater Low setting then return a string with the present setting.</p>

The following are additional notes on using either IEEE-488 Interface program.

- If you enter a correctly spelled query without a “?”, nothing will be returned. Incorrectly spelled commands and queries are ignored. Commands and queries should have a space separating the command and associated parameters.
- Leading zeros and zeros following a decimal point are not needed in a command string, but are sent in response to a query. A leading “+” is not required but a leading “-” is required.

6.1.5 Troubleshooting

New Installation

1. Check instrument address.
2. Always send terminators.
3. Send entire message string at one time including terminators.
4. Send only one simple command at a time until communication is established.
5. Be sure to spell commands correctly and use proper syntax.
6. Attempt both 'Talk' and 'Listen' functions. If one works but not the other, the hardware connection is working, so look at syntax, terminators, and command format.
7. If only one message is received after resetting the interface, check the “repeat addressing” setting. It should be enabled.

Old Installation No Longer Working

1. Power instrument off then on again to see if it is a soft failure.
2. Power computer off then on again to see if the IEEE card is locked up.
3. Verify that the address has not been changed on the instrument during a memory reset.
4. Check all cable connections.

Intermittent Lockups

1. Check cable connections and length.
2. Increase delay between all commands to 50 ms to make sure instrument is not being over loaded.

6.2 SERIAL INTERFACE OVERVIEW

The serial interface used in the Model 331 is commonly referred to as an RS-232C interface. RS-232C is a standard of the Electronics Industries Association (EIA) that describes one of the most common interfaces between computers and electronic equipment. The RS-232C standard is quite flexible and allows many different configurations. However, any two devices claiming RS-232C compatibility cannot necessarily be plugged together without interface setup. The remainder of this paragraph briefly describes the key features of a serial interface that are supported by the instrument. A customer supplied computer with similarly configured interface port is required to enable communication.

6.2.1 Physical Connection

The Model 331 has a 9 pin D-Subminiature plug on the rear panel for serial communication. The original RS-232C standard specifies 25 pins but both 9- and 25-pin connectors are commonly used in the computer industry. Many third party cables exist for connecting the instrument to computers with either 9- or 25-pin connectors. Paragraph 8.4.1 gives the most common pin assignments for 9- and 25-pin connectors. Please note that not all pins or functions are supported by the Model 331.

The instrument serial connector is the plug half of a mating pair and must be matched with a socket on the cable. If a cable has the correct wiring configuration but also has a plug end, a "gender changer" can be used to mate two plug ends together.

The letters DTE near the interface connector stand for Data Terminal Equipment and indicate the pin connection of the directional pins such as transmit data (TD) and receive data (RD). Equipment with Data Communications Equipment (DCE) wiring can be connected to the instrument with a straight through cable. As an example, Pin 3 of the DTE connector holds the transmit line and Pin 3 of the DCE connector holds the receive line so the functions complement.

It is likely both pieces of equipment are wired in the DTE configuration. In this case Pin 3 on one DTE connector (used for transmit) must be wired to Pin 2 on the other (used for receive). Cables that swap the complementing lines are called null modem cables and must be used between two DTE wired devices. Null modem adapters are also available for use with straight through cables. Paragraph 8.4.1 illustrates suggested cables that can be used between the instrument and common computers.

The instrument uses drivers to generate the transmission voltage levels required by the RS-232C standard. These voltages are considered safe under normal operating conditions because of their relatively low voltage and current limits. The drivers are designed to work with cables up to 50 feet in length.

6.2.2 Hardware Support

The Model 331 interface hardware supports the following features. Asynchronous timing is used for the individual bit data within a character. This timing requires start and stop bits as part of each character so the transmitter and receiver can resynchronized between each character. Half duplex transmission allows the instrument to be either a transmitter or a receiver of data but not at the same time. Communication speeds of 300, 1200 or 9600 Baud are supported. The Baud rate is the only interface parameter that can be changed by the user.

Hardware handshaking is not supported by the instrument. Handshaking is often used to guarantee that data message strings do not collide and that no data is transmitted before the receiver is ready. In this instrument appropriate software timing substitutes for hardware handshaking. User programs must take full responsibility for flow control and timing as described in Paragraph 6.2.5.

6.2.3 Character Format

A character is the smallest piece of information that can be transmitted by the interface. Each character is 10 bits long and contains data bits, bits for character timing and an error detection bit. The instrument uses 7 bits for data in the ASCII format. One start bit and one stop bit are necessary to synchronize consecutive characters. Parity is a method of error detection. One parity bit configured for odd parity is included in each character.

ASCII letter and number characters are used most often as character data. Punctuation characters are used as delimiters to separate different commands or pieces of data. Two special ASCII characters, carriage return (CR 0DH) and line feed (LF 0AH), are used to indicate the end of a message string.

Table 6-4. Serial Interface Specifications

Connector Type:	9-pin D-style connector plug
Connector Wiring:	DTE
Voltage Levels:	EIA RS-232C Specified
Transmission Distance:	50 feet maximum
Timing Format:	Asynchronous
Transmission Mode:	Half Duplex
Baud Rate:	300, 1200, 9600
Handshake:	Software timing
Character Bits:	1 Start, 7 Data, 1 Parity, 1 Stop
Parity:	Odd
Terminators:	CR(0DH) LF(0AH)
Command Rate:	20 commands per second maximum

6.2.4 Message Strings

A message string is a group of characters assembled to perform an interface function. There are three types of message strings commands, queries and responses. The computer issues command and query strings through user programs, the instrument issues responses. Two or more command strings can be chained together in one communication but they must be separated by a semi-colon (;). Only one query is permitted per communication but it can be chained to the end of a command. The total communication string must not exceed 64 characters in length.

A command string is issued by the computer and instructs the instrument to perform a function or change a parameter setting. The format is:

`<command mnemonic><space><parameter data><terminators>.`

Command mnemonics and parameter data necessary for each one is described in Paragraph 6.3. Terminators must be sent with every message string.

A query string is issued by the computer and instructs the instrument to send a response. The query format is:

`<query mnemonic><?><space><parameter data><terminators>.`

Query mnemonics are often the same as commands with the addition of a question mark. Parameter data is often unnecessary when sending queries. Query mnemonics and parameter data if necessary is described in Paragraph 6.3. Terminators must be sent with every message string. The computer should expect a response very soon after a query is sent.

A response string is the instruments response or answer to a query string. The instrument will respond only to the last query it receives. The response can be a reading value, status report or the present value of a parameter. Response data formats are listed along with the associated queries in Paragraph 6.3. The response is sent as soon as possible after the instrument receives the query. Typically it takes 10 ms for the instrument to begin the response. Some responses take longer.

6.2.5 Message Flow Control

It is important to remember that the user program is in charge of the serial communication at all times. The instrument can not initiate communication, determine which device should be transmitting at a given time or guarantee timing between messages. All of this is the responsibility of the user program.

When issuing commands only the user program should:

- Properly format and transmit the command including terminators as one string.
- Guarantee that no other communication is started for 50 ms after the last character is transmitted.
- Not initiate communication more than 20 times per second.

When issuing queries or queries and commands together the user program should:

- Properly format and transmit the query including terminators as one string.
- Prepare to receive a response immediately.
- Receive the entire response from the instrument including the terminators.
- Guarantee that no other communication is started during the response or for 50 ms after it completes.
- Not initiate communication more than 20 times per second.

Failure to follow these simple rules will result in inability to establish communication with the instrument or intermittent failures in communication.

6.2.6 Changing Baud Rate

To use the Serial Interface, you must first set the Baud rate. Press **Interface** key to display the following screen.

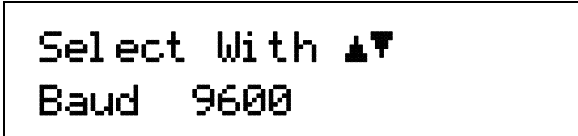

```
Select With ▲▼  
Baud 9600
```

Press the ▲ or ▼ key to cycle through the choices of 300, 1200, or 9600 Baud. Press the **Enter** key to accept the new number.

6.2.7 Serial Interface Example Programs

Two BASIC programs are included to illustrate the serial communication functions of the instrument. The first program was written in Visual Basic. Refer to Paragraph 6.2.7.1 for instructions on how to setup the program. The Visual Basic code is provided in Table 6-6. The second program was written in Quick Basic. Refer to Paragraph 6.2.7.2 for instructions on how to setup the program. The Quick Basic code is provided in Table 6-7. Finally, a description of operation common to both programs is provided in Paragraph 6.2.7.3. While the hardware and software required to produce and implement these programs not included with the instrument, the concepts illustrated apply to almost any application where these tools are available.

6.2.7.1 Visual Basic Serial Interface Program Setup

The serial interface program works with Visual Basic 6.0 (VB6) on an IBM PC (or compatible) with a Pentium-class processor. A Pentium 90 or higher is recommended, running Windows 95 or better, with a serial interface. It uses the COM1 communications port at 9600 Baud. Use the following procedure to develop the Serial Interface Program in Visual Basic.

1. Start VB6.
2. Choose Standard EXE and select Open.
3. Resize form window to desired size.
4. On the Project Menu, click Components to bring up a list of additional controls available in VB6.
5. Scroll through the controls and select Microsoft Comm Control 6.0. Select OK. In the toolbar at the left of the screen, the Comm Control will have appeared as a telephone icon.
6. Select the Comm control and add it to the form.
7. Add controls to form:
 - a. Add three Label controls to the form.
 - b. Add two TextBox controls to the form.
 - c. Add one CommandButton control to the form.
 - d. Add one Timer control to the form.
8. On the View Menu, select Properties Window.
9. In the Properties window, use the dropdown list to select between the different controls of the current project.

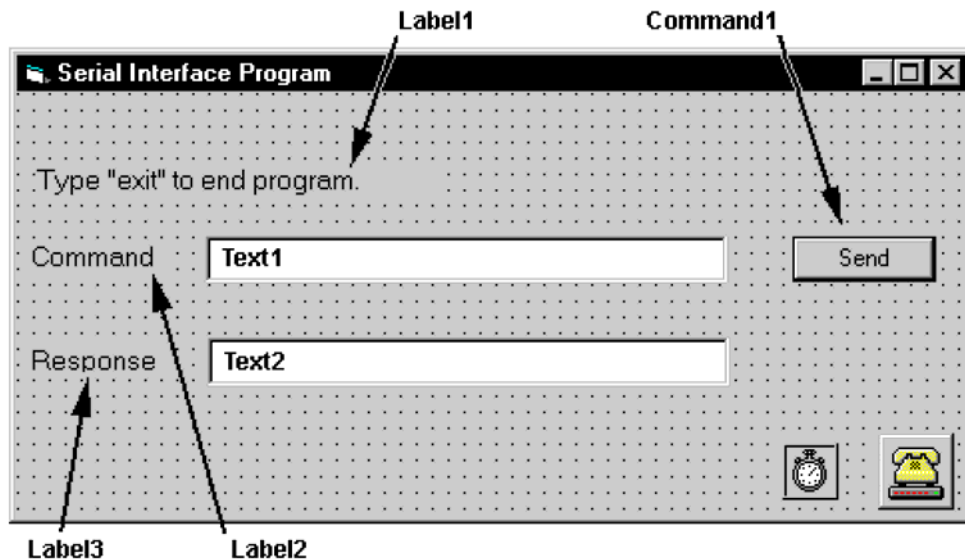

10. Set the properties of the controls as defined in Table 6-5.
11. Save the program.

Table 6-5. Serial Interface Program Control Properties

Current Name	Property	New Value
Label1	Name Caption	lblExitProgram Type "exit" to end program.
Label2	Name Caption	lblCommand Command
Label3	Name Caption	lblResponse Response
Text1	Name Text	txtCommand <blank>
Text2	Name Text	txtResponse <blank>
Command1	Name Caption Default	cmdSend Send True
Form1	Name Caption	frmSerial Serial Interface Program
Timer1	Enabled Interval	False 10

12. Add code (provided in Table 6-6).
 - a. In the Code Editor window, under the Object dropdown list, select (General). Add the statement: Public gSend as Boolean
 - b. Double Click on cmdSend. Add code segment under Private Sub cmdSend_Click() as shown in Table 6-6.
 - c. In the Code Editor window, under the Object dropdown list, select Form. Make sure the Procedure dropdown list is set at Load. The Code window should have written the segment of code: Private Sub Form_Load(). Add the code to this subroutine as shown in Table 6-6.
 - d. Double Click on the Timer control. Add code segment under Private Sub Timer1_Timer() as shown in Table 6-6.
 - e. Make adjustments to code if different Com port settings are being used.
13. Save the program.
14. Run the program. The program should resemble the following.

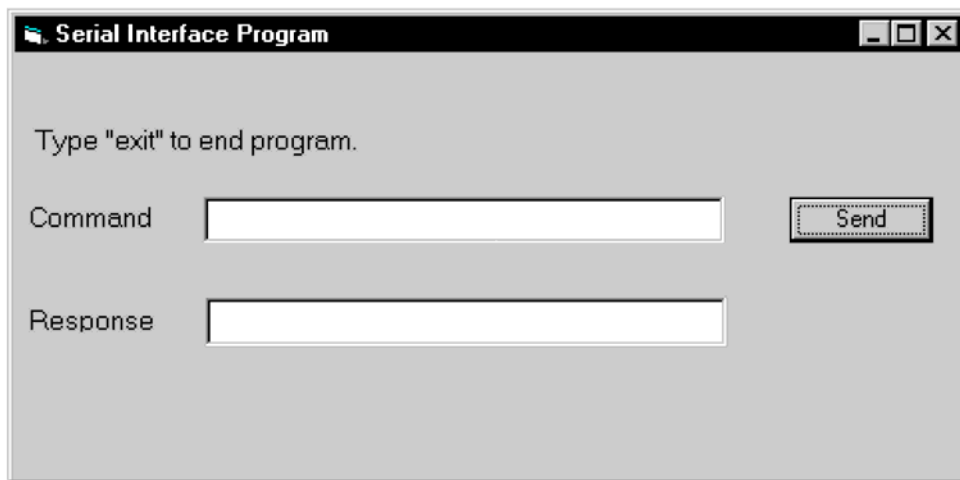

15. Type in a command or query in the Command box as described in Paragraph 6.2.7.3.
16. Press Enter or select the Send button with the mouse to send command.
17. Type Exit and press Enter to quit.

Table 6-6. Visual Basic Serial Interface Program

Public gSend As Boolean	'Global used for Send button state
Private Sub cmdSend_Click() gSend = True End Sub	'Routine to handle Send button press 'Set Flag to True
Private Sub Form_Load() Dim strReturn As String Dim strHold As String Dim Term As String Dim ZeroCount As Integer Dim strCommand As String frmSerial.Show Term = Chr(13) & Chr(10) ZeroCount = 0 strReturn = "" strHold = "" If frmSerial.MSComm1.PortOpen = True Then frmSerial.MSComm1.PortOpen = False End If frmSerial.MSComm1.CommPort = 1 frmSerial.MSComm1.Settings = "9600,o,7,1" frmSerial.MSComm1.InputLen = 1 frmSerial.MSComm1.PortOpen = True Do Do DoEvents Loop Until gSend = True gSend = False strCommand = frmSerial.txtCommand.Text strReturn = "" strCommand = UCase(strCommand) If strCommand = "EXIT" Then End End If frmSerial.MSComm1.Output = strCommand & Term If InStr(strCommand, "?") <> 0 Then While (ZeroCount < 20) And (strHold <> Chr\$(10)) If frmSerial.MSComm1.InBufferCount = 0 Then frmSerial.Timer1.Enabled = True Do DoEvents Loop Until frmSerial.Timer1.Enabled = False ZeroCount = ZeroCount + 1 Else ZeroCount = 0 strHold = frmSerial.MSComm1.Input strReturn = strReturn + strHold End If Wend If strReturn <> "" Then strReturn = Mid(strReturn, 1, InStr(strReturn, Term) - 1) 'Strip terminators Else strReturn = "No Response" End If frmSerial.txtResponse.Text = strReturn strHold = "" ZeroCount = 0 End If Loop End Sub	'Main code section 'Used to return response 'Temporary character space 'Terminators 'Counter used for Timing out 'Data string sent to instrument 'Show main window 'Terminators are <CR><LF> 'Initialize counter 'Clear return string 'Clear holding string 'Close serial port to change settings 'Example of Comm 1 'Example of 9600 Baud,Parity,Data,Stop 'Read one character at a time 'Open port 'Wait loop 'Give up processor to other events 'Loop until Send button pressed 'Set Flag as false 'Get Command 'Clear response display 'Set all characters to upper case 'Get out on EXIT 'Send command to instrument 'Check to see if query 'Wait for response 'Add 1 to timeout if no character 'Wait for 10 millisecond timer 'Timeout at 2 seconds 'Reset timeout for each character 'Read in one character 'Add next character to string 'Get characters until terminators 'Check if string empty 'Send No Response 'Put response in textbox on main form 'Reset holding string 'Reset timeout counter
Private Sub Timer1_Timer() frmSerial.Timer1.Enabled = False End Sub	'Routine to handle Timer interrupt 'Turn off timer

6.2.7.2 Quick Basic Serial Interface Program Setup

The serial interface program listed in Table 6-7 works with QuickBasic 4.0/4.5 or Qbasic on an IBM PC (or compatible) running DOS or in a DOS window with a serial interface. It uses the COM1 communication port at 9600 Baud. Use the following procedure to develop the Serial Interface Program in Quick Basic.

1. Start the Basic program.
2. Enter the program exactly as presented in Table 6-7.
3. Adjust the Com port and Baud rate in the program as necessary.
4. Lengthen the "TIMEOUT" count if necessary.
5. Save the program.
6. Run the program.
7. Type a command query as described in Paragraph 6.2.7.3.
8. Type "EXIT" to quit the program.

Table 6-7. Quick Basic Serial Interface Program

```

CLS                                     'Clear screen
PRINT " SERIAL COMMUNICATION PROGRAM"
PRINT
TIMEOUT = 2000                          'Read timeout (may need more)
BAUD$ = "9600"
TERM$ = CHR$(13) + CHR$(10)             'Terminators are <CR><LF>
OPEN "COM1:" + BAUD$ + ",O,7,1,RS" FOR RANDOM AS #1 LEN = 256

LOOP1: LINE INPUT "ENTER COMMAND (or EXIT):"; CMD$      'Get command from keyboard
CMD$ = UCASE$(CMD$)                                     'Change input to upper case
IF CMD$ = "EXIT" THEN CLOSE #1: END                     'Get out on Exit
CMD$ = CMD$ + TERM$
PRINT #1, CMD$;                                         'Send command to instrument

IF INSTR(CMD$, "?") <> 0 THEN                            'Test for query
  RS$ = ""                                              'If query, read response
  N = 0                                                 'Clr return string and count

  WHILE (N < TIMEOUT) AND (INSTR(RS$, TERM$) = 0)      'Wait for response
    IN$ = INPUT$(LOC(1), #1)                             'Get one character at a time
    IF IN$ = "" THEN N = N + 1 ELSE N = 0                'Add 1 to timeout if no chr
    RS$ = RS$ + IN$                                     'Add next chr to string
  WEND                                                  'Get chrs until terminators

  IF RS$ <> "" THEN                                       'See if return string is empty
    RS$ = MID$(RS$, 1, (INSTR(RS$, TERM$) - 1))         'Strip off terminators
    PRINT "RESPONSE: "; RS$                             'Print response to query
  ELSE
    PRINT "NO RESPONSE"                                  'No response to query
  END IF
END IF                                                 'Get next command
GOTO LOOP1

```

6.2.7.3 Program Operation

Once either example program is running, try the following commands and observe the response of the instrument. Input from the user is shown in **bold** and terminators are added by the program. The word [term] indicates the required terminators included with the response.

ENTER COMMAND? ***IDN?** Identification query. Instrument will return a string identifying itself.
 RESPONSE: LSCI,MODEL331S,123456,020399 [term]

ENTER COMMAND? **KRDG?** Temperature reading in kelvin query. Instrument will return a string with the present temperature reading.
 RESPONSE: +273.15 [term]

ENTER COMMAND? **RANGE 0** Heater range command. Instrument will turn off the heater. No response will be sent.

ENTER COMMAND? **RANGE?** Heater range query. Instrument will return a string with the present heater range setting.
 RESPONSE: 0 [term]

ENTER COMMAND? **RANGE 1;RANGE?** Heater range command followed by a query. Instrument will change to heater Low setting then return a string with the present setting.
 RESPONSE: 1 [term]

The following are additional notes on using either Serial Interface program.

- If you enter a correctly spelled query without a “?”, nothing will be returned. Incorrectly spelled commands and queries are ignored. Commands and queries and should have a space separating the command and associated parameters.
- Leading zeros and zeros following a decimal point are not needed in a command string, but they will be sent in response to a query. A leading “+” is not required but a leading “-” is required.

6.2.8 Troubleshooting

New Installation

1. Check instrument Baud rate.
2. Make sure transmit (TD) signal line from the instrument is routed to receive (RD) on the computer and vice versa. (Use a null modem adapter if not).
3. Always send terminators.
4. Send entire message string at one time including terminators. (Many terminal emulation programs do not.)
5. Send only one simple command at a time until communication is established.
6. Be sure to spell commands correctly and use proper syntax.

Old Installation No Longer Working

1. Power instrument off then on again to see if it is a soft failure.
2. Power computer off then on again to see if communication port is locked up.
3. Verify that Baud rate has not been changed on the instrument during a memory reset.
4. Check all cable connections.

Intermittent Lockups

1. Check cable connections and length.
2. Increase delay between all commands to 100 ms to make sure instrument is not being over loaded.

6.3 COMMAND SUMMARY

This paragraph provides a listing of the IEEE-488 and Serial Interface Commands. A summary of all the commands is provided in Table 6-8. All the commands are detailed in Paragraph 6.3.1, which is presented in alphabetical order.

Sample Command Format

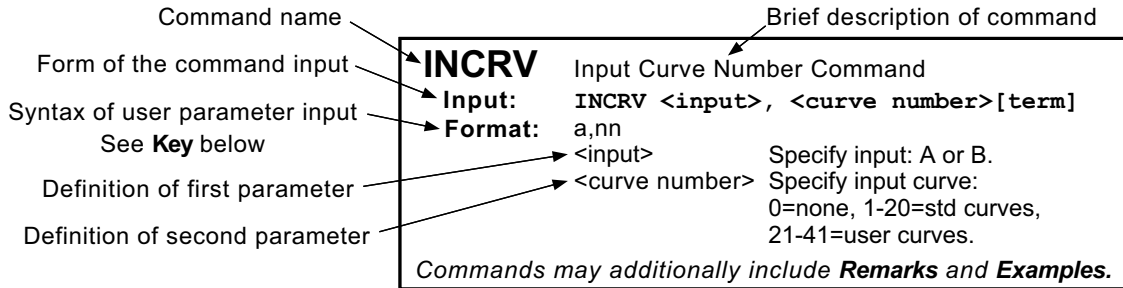

Sample Query Format

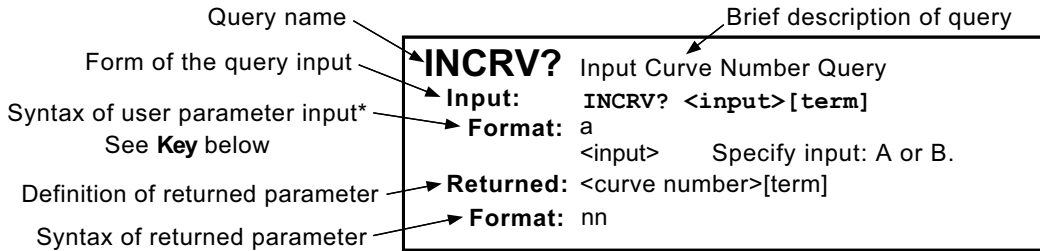

*The initial **Format** definition is omitted for queries that do not require parameter input.*

Key

- *** Begins common interface command.
- ?** Required to identify queries.
- aa... String of alpha numeric characters.
- nn... String of number characters that may include a decimal point.
- [term] Terminator characters.
- <...> Indicated a parameter field, many are command specific.
- <state> Parameter field with only On/Off or Enable/Disable states.
- <value> Floating point values have varying resolution depending on the type of command or query issued.

Table 6-8. Command Summary

<u>Command</u>	<u>Function</u>	<u>Page</u>	<u>Command</u>	<u>Function</u>	<u>Page</u>
*CLS	Clear Interface Cmd	24	HTR?	Heater Output Query	32
*ESE	Event Status Enable Cmd	24	HTRST?	Heater Status Query	32
*ESE?	Event Status Enable Query	24	IEEE	IEEE Interface Parameter Cmd	32
*ESR?	Event Status Register Query	24	IEEE?	IEEE Interface Parameter Query	32
*IDN?	Identification Query	24	INCRV	Input Curve Number Cmd	32
*OPC	Operation Complete Cmd	25	INCRV?	Input Curve Number Query	32
*OPC?	Operation Complete Query	25	INTYPE	Input Type Parameter Cmd	33
*RST	Reset Instrument Cmd	25	INTYPE?	Input Type Parameter Query	33
*SRE	Service Request Enable Cmd	25	KEYST?	Keypad Status Query	33
*SRE?	Service Request Enable Query	25	KRDG?	Kelvin Reading Query	33
*STB?	Status Byte Query	25	LDAT?	Linear Equation Data Query	33
*TST?	Self-Test Query	26	LINEAR	Input Linear Equation Cmd	34
*WAI	Wait-To-Continue Cmd	26	LINEAR?	Input Linear Equation Query	34
ALARM	Input Alarm Parameter Cmd	26	LOCK	Front Panel Keyboard Lock Cmd	34
ALARM?	Input Alarm Parameter Query	26	LOCK?	Front Panel Keyboard Lock Query	34
ALARMST?	Input Alarm Status Query	26	MDAT?	Min/Max Data Query	34
ALMRST	Reset Alarm Status Cmd	27	MNMX	Min/Max Input Function Cmd	35
ANALOG	Analog Output Parameter Cmd	27	MNMX?	Min/Max Input Function Query	35
ANALOG?	Analog Outputs Parameter Query	27	MNMXRST	Min/Max Function Reset Cmd	35
AOUT?	Analog Output Data Query	27	MODE	Set Local/Remote Mode	35
BAUD	RS-232 Baud Rate Cmd	27	MODE?	Query Local/Remote Mode	35
BAUD?	RS-232 Baud Rate Query	27	MOUT	Control Loop MHP Output Cmd	35
BEEP	System Beeper Cmd	28	MOUT?	Control Loop MHP Output Query	35
BEEP?	System Beeper Query	28	PID	Control Loop PID Values Cmd	36
BRIGT	Display Brightness Command	28	PID?	Control Loop PID Values Query	36
BRIGT?	Display Brightness Query	28	RAMP	Control Loop Ramp Cmd	36
CMODE	Control Loop Mode Cmd	28	RAMP?	Control Loop Ramp Query	36
CMODE?	Control Loop Mode Query	28	RAMPST?	Control Loop Ramp Status Query	36
CRDG?	Celsius Reading Query	28	RANGE	Heater Range Cmd	37
CRVDEL	Delete User Curve Cmd	29	RANGE?	Heater Range Query	37
CRVHDR	Curve Header Cmd	29	RDGST?	Input Status Query	37
CRVHDR?	Curve Header Query	29	RELAY	Relay Control Parameter Cmd	37
CRVPT	Curve Data Point Cmd	29	RELAY?	Relay Control Parameter Query	37
CRVPT?	Curve Data Point Query	30	RELAYST?	Relay Status Query	37
CSET	Control Loop Parameter Cmd	30	REV?	Input Firmware Revision Query	38
CSET?	Control Loop Parameter Query	30	SCAL	Generate SoftCal Curve Cmd	38
DFLT	Factory Defaults Cmd	30	SETP	Control Loop Setpoint Cmd	38
DISPFLD	Displayed Field Cmd	30	SETP?	Control Loop Setpoint Query	38
DISPFLD?	Displayed Field Query	31	SRDG?	Sensor Units Reading Query	38
EMUL	330 Emulation Mode Cmd	31	TEMP?	Room-Temp Comp. Temp. Query	39
EMUL?	330 Emulation Mode Query	31	TUNEST?	Control Loop 1 Tuning Query	39
FILTER	Input Filter Parameter Cmd	31	ZONE	Control Loop Zone Table Cmd	39
FILTER?	Input Filter Parameter Query	31	ZONE?	Control Loop Zone Table Query	39

6.3.1 Interface Commands (Alphabetical Listing)

***CLS** Clear Interface Command

Input: *CLS [term]

Remarks: Clears the bits in the Status Byte Register and Standard Event Status Register and terminates all pending operations. Clears the interface, but *not* the controller. The related controller command is ***RST**.

***ESE** Event Status Enable Register Command

Input: *ESE <bit weighting> [term]

Format: nnn

Remarks: Each bit is assigned a bit weighting and represents the enable/disable mask of the corresponding event flag bit in the Standard Event Status Register. To enable an event flag bit, send the command ***ESE** with the sum of the bit weighting for each desired bit. Refer to Paragraph 6.1.3.2 for a list of event flags.

Example: To enable event flags 0, 3, 4, and 7, send the command ***ESE 143[term]**. 143 is the sum of the bit weighting for each bit.

Bit	Bit Weighting	Event Name
0	1	OPC
3	8	DDE
4	16	EXE
7	128	PON
	143	

***ESE?** Event Status Enable Register Query

Input: *ESE? [term]

Returned: <bit weighting>[term]

Format: nnn Refer to Paragraph 6.1.3.2 for a list of event flags.

***ESR?** Standard Event Status Register Query

Input: *ESR? [term]

Returned: <bit weighting>

Format: nnn

Remarks: The integer returned represents the sum of the bit weighting of the event flag bits in the Standard Event Status Register. Refer to Paragraph 6.1.3.2 for a list of event flags.

***IDN?** Identification Query

Input: *IDN? [term]

Returned: <manufacturer>,<model>,<serial>,<date>[term]

Format: aaaa,aaaaaaaa,aaaaaa,mmdyy

<manufacture> Manufacturer ID

<model> Instrument model number

<serial> Serial number

<date> Instrument firmware revision date

Example: LSCI,MODEL331S,123456,020399

***OPC** Operation Complete Command

Input: ***OPC [term]**

Remarks: Generates an Operation Complete event in the Event Status Register upon completion of all pending selected device operations. Send it as the last command in a command string.

***OPC?** Operation Complete Query

Input: ***OPC? [term]**

Returned: 1[term]

Remarks: Places a "1" in the controller output queue upon completion of all pending selected device operations. Send as the last command in a command string. *Not* the same as ***OPC**.

***RST** Reset Instrument Command

Input: ***RST [term]**

Remarks: Sets controller parameters to power-up settings.

***SRE** Service Request Enable Register Command

Input: ***SRE <bit weighting> [term]**

Format: nnn

Remarks: Each bit has a bit weighting and represents the enable/disable mask of the corresponding status flag bit in the Status Byte Register. To enable a status flag bit, send the command ***SRE** with the sum of the bit weighting for each desired bit. Refer to Paragraph 6.1.3.1 for a list of status flags.

Example: To enable status flags 0, 2, 4, and 6, send the command ***SRE 89[term]**. 89 is the sum of the bit weighting for each bit.

<u>Bit</u>	<u>Bit Weighting</u>	<u>Event Name</u>
0	1	New A&B
3	8	Alarm
4	16	Error
6	<u>64</u>	SRQ
	89	

***SRE?** Service Request Enable Register Query

Input: ***SRE? [term]**

Returned: <bit weighting>[term]

Format: nnn Refer to Paragraph 6.1.3.1 for a list of status flags.

***STB?** Status Byte Query

Input: ***STB? [term]**

Returned: <bit weighting>[term]

Format: nnn

Remarks: Acts like a serial poll, but does not reset the register to all zeros. The integer returned represents the sum of the bit weighting of the status flag bits that are set in the Status Byte Register. Refer to Paragraph 6.1.3.1 for a list of status flags.

***TST?** Self-Test Query
Input: ***TST?** [term]
Returned: <status>[term]
Format: n
 <status> 0 = no errors found, 1 = errors found
Remarks: The Model 331 reports status based on test done at power up.

***WAI** Wait-to-Continue Command
Input: ***WAI** [term]
Remarks: This command is not supported in the Model 331.

ALARM Input Alarm Parameter Command
Input: **ALARM** <input>, <off/on>, <source>, <high value>, <low value>, <deadband>, <latch enable> [term]
Format: a,n,n,±nnnnnn,±nnnnnn,±nnnnnn,n
 <input> Specifies which input to configure: A or B.
 <off/on> Determines whether the instrument checks the alarm for this input, where 0 = off and 1 = on.
 <source> Specifies input data to check. Valid entries: 1 = kelvin, 2 = Celsius, 3 = sensor units, 4 = linear data.
 <high value> Sets the value the source is checked against to activate the high alarm.
 <low value> Sets the value the source is checked against to activate low alarm.
 <deadband> Sets the value that the source must change outside of an alarm condition to deactivate an unlatched alarm.
 <latch enable> Specifies a latched alarm (remains active after alarm condition correction) where 0 = off (no latch) and 1 = on.
Remarks: Configures the alarm parameters for an input.
Example: **ALARM A,0**[term] – Turns off alarm checking for Input A.
ALARM B,1,1,270.0,0,0,1[term] – Turns on alarm checking for input B, activates high alarm if kelvin reading is over 270, and latches the alarm when kelvin reading falls below 270.

ALARM? Input Alarm Parameter Query
Input: **ALARM?** <input> [term]
Format: a
 <input> A or B
Returned: <off/on>, <source>, <high value>, <low value>, <deadband>, <latch enable> [term]
Format: n,n,±nnnnnn,±nnnnnn,±nnnnnn,n (Refer to command for description)

ALARMST? Input Alarm Status Query
Input: **ALARMST?** <input> [term]
Format: a
 <input> A or B
Returned: <high state>, <low state>[term]
Format: n,n
 <high state> 0 = Off, 1 = On
 <low state> 0 = Off, 1 = On

ALMRST Reset Alarm Status Command

Input: ALMRST [term]

Remarks: Clears both the high and low status of all alarms, including latching alarms.

ANALOG Analog Output Parameter Command

Input: ANALOG <bipolar enable>, <mode>, <input>, <source>, <high value>, <low value>, <manual value>[term]

Format: n,n,a,n,±nnnnnn,±nnnnnn,±nnnnnn

<bipolar enable> Specifies analog output is 0 = positive output only or 1 = bipolar.

<mode> Specifies data the analog output monitors. Valid entries: 0 = off, 1 = input, 2 = manual, 3 = loop.

<input> Specifies which input to monitor if <mode> = 1.

<source> Specifies input data. Valid entries: 1 = kelvin, 2 = Celsius, 3 = sensor units, 4 = linear equation.

<high value> If <mode> is 1, this parameter represents the data at which the analog output reaches +100% output.

<low value> If <mode> is 1, this parameter represents the data at which the analog output reaches -100% output if bipolar, or 0% output if positive only.

<manual value> If <mode> is 2, this parameter is the output of the analog output.

Example: ANALOG 0,1,A,1,100.0,0.0[term] – Sets analog output to monitor Input A kelvin reading with 100.0 K at +100% output (+10.0 V) and 0.0 K at 0% output (0.0 V).

ANALOG? Analog Output Parameter Query

Input: ANALOG? [term]

Returned: <bipolar enable>, <mode>, <input>, <source>, <high value>, <low value>, <manual value>[term]

Format: n,n,a,n,±nnnnnn,±nnnnnn,±nnnnnn (Refer to command for definition)

AOUT? Analog Output Data Query

Input: AOUT? [term]

Returned: <analog output>[term]

Format: ±nnn.n

Remarks: Returns the percentage of output of the analog output. Most often used for input or loop modes when the output value is set by the instrument. Resolution is 0.5%.

BAUD RS-232 Baud Rate Command

Input: BAUD <bps> [term]

Format: n
<bps> Specifies Baud rate: 0 = 300 Baud, 1 = 1200 Baud, 2 = 9600 Baud.

BAUD? RS-232 Baud Rate Query

Input: BAUD?

Returned: <bps> [term]

Format: n (Refer to command for description)

BEEP Alarm Beeper Command
Input: BEEP <state> [term]
Format: n
 <state> 0 = Off, 1 = On.
Remarks: Enables or disables system beeper sound when an alarm condition is met.

BEEP? Alarm Beeper Query
Input: BEEP?
Returned: <state> [term]
Format: n (Refer to command for description)

BRIGT Display Brightness Command
Input: BRIGT <bright> [term]
Format: n
 <bright> 0 = 25%, 1 = 50%, 2 = 75%, 3 = 100%. Default = 2.

BRIGT? Display Brightness Query
Input: BRIGT? [term]
Returned: <bright>[term]
Format: n (Refer to command for description)

CMODE Control Loop Mode Command
Input: CMODE <loop>, <mode> [term]
Format: n,n
 <loop> Specifies which loop to configure: 1 or 2.
 <mode> Specifies the control mode. Valid entries: 1 = Manual PID, 2 = Zone, 3 = Open Loop, 4 = AutoTune PID, 5 = AutoTune PI, 6 = AutoTune P.
Example: CMODE 1,4[term] – Control Loop 1 uses PID AutoTuning.

CMODE? Control Loop Mode Query
Input: CMODE? <loop> [term]
Format: n
 <loop> Specifies which loop to query: 1 or 2.
Returned: <mode>[term]
Format: n (Refer to command for description)

CRDG? Celsius Reading Query
Input: CRDG? <input> [term]
Format: a
 <input> A or B
Returned: <temp value>[term]
Format: ±nnnnnn
Remarks: Also see the RDGST? command.

CRVDEL Curve Delete Command

Input: CRVDEL <curve> [term]

Format: nn
 <curve> Specifies a user curve to delete. Valid entries: 21–41.

Example: CRVDEL 21[term] – Deletes User Curve 21.

CRVHDR Curve Header Command

Input: CRVHDR <curve>, <name>, <SN>, <format>, <limit value>, <coefficient> [term]

Format: nn,aaaaaaaaaaaaaaaa,aaaaaaaaa,n,±nnn.nnn,n
 <curve> Specifies which curve to configure. Valid entries: 21–41.
 <name> Specifies curve name. Limited to 15 characters.
 <SN> Specifies the curve serial number. Limited to 10 characters.
 <format> Specifies the curve data format. Valid entries: 1 = mV/K, 2 = V/K, 3 = Ω/K, 4 = log Ω/K.
 <limit value> Specifies the curve temperature limit in kelvin.
 <coefficient> Specifies the curves temperature coefficient. Valid entries: 1 = negative, 2 = positive.

Remarks: Configures the user curve header.

Example: CRVHDR 21,DT-470,00011134,2,325.0,1[term] – Configures User Curve 21 with a name of DT-470, serial number of 00011134, data format of volts versus kelvin, upper temperature limit of 325 K, and negative coefficient.

CRVHDR? Curve Header Query

Input: CRVHDR? <curve> [term]

Format: nn
 <curve> Valid entries: 1–41.

Returned: <name>, <SN>, <format>, <limit value>, <coefficient> [term]

Format: aaaaaaaaaaaaaaaaa,aaaaaaaaa,n,±nnn.nnn,n (Refer to command for description)

CRVPT Curve Data Point Command

Input: CRVPT <curve>, <index>, <units value>, <temp value> [term]

Format: nn,nnn,±nnnnnnn,±nnnnnnn
 <curve> Specifies which curve to configure. Valid entries: 21–41.
 <index> Specifies the points index in the curve. Valid entries: 1–200.
 <units value> Specifies sensor units for this point to 6 digits.
 <temp value> Specifies the corresponding temperature in kelvin for this point to 6 digits.

Remarks: Configures a user curve data point.

Example: CRVPT 21,2,0.10191,470.000,N[term] – Sets User Curve 21 second data point to 0.10191 sensor units and 470.000 K.

CRVPT? Curve Data Point Query

Input: CRVPT? <curve>, <index> [term]

Format: nn,nnn

<curve> Specifies which curve to query: 1–41.

<index> Specifies the points index in the curve: 1–200.

Returned: <units value>, <temp value>[term]

Format: ±nnnnnnn,±nnnnnnn (Refer to command for description)

Remarks: Returns a standard or user curve data point.

CSET Control Loop Parameter Command

Input: CSET <loop>, <input>, <units>, <powerup enable>, <current/power> [term]

Format: n,a,n,n,n

<loop> Specifies which loop to configure: 1 or 2.

<input> Specifies which input to control from: A or B.

<units> Specifies setpoint units. Valid entries: 1 = kelvin, 2 = Celsius, 3 = sensor units.

<powerup enable> Specifies whether the control loop is on or off after power-up, where 0 = powerup enable off and 1 = powerup enable on.

<current/power> Specifies whether the heater output displays in current or power. Valid entries: 1 = current or 2 = power.

Example: CSET 1,A,1,1[term] – Control Loop 1 controls off of Input A with setpoint in kelvin.

CSET? Control Loop Parameter Query

Input: CSET? <loop> [term]

Format: n

<loop> Specifies which loop to query: 1 or 2.

Returned: <input>, <units>, <powerup enable>, <current/power>[term]

Format: a,n,n,n (Refer to command for description)

DFLT Factory Defaults Command

Input: DFLT 99 [term]

Remarks: Sets all configuration values to factory defaults and resets the instrument. The "99" is included to prevent accidentally setting the unit to defaults.

DISPFLD Displayed Field Command

Input: DISPFLD <field>, <item>, <source> [term]

Format: n,n,n

<field> Specifies field to configure: 1–4.

<item> Specifies item to display in the field: 0 = Off, 1 = Input A, 2 = Input B, 3 = Setpoint, 4 = Heater Output.

<source> If Item is 1 or 2, specifies input data to display. Valid entries: 1 = kelvin, 2 = Celsius, 3 = sensor units, 4 = linear data, 5 = minimum data, and 6 = maximum data.

Example: DISPFLD 2,1,1[term] – Displays kelvin reading for Input A in display field 2.

DISPFLD? Displayed Field Query

Input: DISPFLD? <field> [term]
Format: n
 <field> Specifies field to query: 1–4.
Returned: <item>, <source>[term]
Format: n,n (Refer to command for description)

EMUL 330 Emulation Mode Command

Input: EMUL <off/on> [term]
Format: n
 <off/on> Specifies whether 330 Emulation Mode is 0 = Off or 1 = On. Default = 0.
Remarks: The 330 Emulation Mode allows the remote interface of the Model 331 to be compatible with Model 330 commands. The 330 Emulation Mode only affects remote operation; front panel operation of the Model 331 is not changed. In 330 Emulation Mode, curve locations are mapped to match Model 330 locations. For example, the DT-500-D Curve, found at curve location 3 in the Model 331, is mapped to location 0 when in 330 mode. This applies to the following remote commands: ACUR, ACUR?, BCUR, BCUR?. The following Model 330 commands are not supported in 330 Emulation Mode: CUID?, CURV, CURV?, ECUR, KCUR, and SCAL.

EMUL? 330 Emulation Mode Query

Input: EMUL? [term]
Returned: <off/on >[term]
Format: n (Refer to command for description)

FILTER Input Filter Parameter Command

Input: FILTER <input>, <off/on>, <points>, <window> [term]
Format: a,n,nn,nn
 <input> Specifies input to configure: A or B.
 <off/on> Specifies whether the filter function is 0 = Off or 1 = On.
 <points> Specifies how many data points the filtering function uses. Valid range = 2 to 64.
 <window> Specifies what percent of full scale reading limits the filtering function. Reading changes greater than this percentage reset the filter. Valid range = 1 to 10%.
Example: FILTER B,1,10,2[term] – Filter input B data through 10 readings with 2% of full scale window.

FILTER? Input Filter Parameter Query

Input: FILTER? <input> [term]
Format: a
 <input> Specifies input to query: A or B.
Returned: <off/on >, <points>, <window>[term]
Format: n,nn,nn (Refer to command for description)

HTR? Heater Output Query

Input: HTR? [term]

Returned: <heater value>[term]

Format: +nnn.n

<heater value> Loop 1 heater output in percent (%). Use AOUT? for Loop 2.

HTRST? Heater Status Query

Input: HTRST? [term]

Returned: <error code>[term]

Format: n

<error code> Heater error code: 0 = no error, 1 = heater open load, 2 = heater short.

IEEE IEEE-488 Interface Parameter Command

Input: IEEE <terminator>, <EOI enable>, <address>[term]

Format: n,n,nn

<terminator> Specifies the terminator. Valid entries: 0 = <CR><LF>, 1 = <LF><CR>, 2 = <LF>, 3 = no terminator (must have EOI enabled).

<EOI enable> Sets EOI mode: 0 = enabled, 1 = disabled.

<address> Specifies the IEEE address: 1–30. (Address 0 and 31 are reserved.)

Example: IEEE 0,0,4[term] – After receipt of the current terminator, the instrument uses EOI mode, uses <CR><LF> as the new terminator, and responds to address 4.

IEEE? IEEE-488 Interface Parameter Query

Input: IEEE? [term]

Returned: <terminator>, <EOI enable>, <address>[term]

Format: n,n,nn (Refer to command for description)

INCRV Input Curve Number Command

Input: INCRV <input>, <curve number>[term]

Format: a,nn

<input> Specifies which input to configure: A or B.

<curve number> Specifies which curve the input uses. If specified curve parameters do not match the input, the curve number defaults to 0. Valid entries: 0 = none, 1–20 = standard curves, 21–41 = user curves.

Remarks: Specifies the curve an input uses for temperature conversion.

Example: INCRV A,23[term] – Input A uses User Curve 23 for temperature conversion.

INCRV? Input Curve Number Query

Input: INCRV? <input>[term]

Format: a

<input> Specifies which input to query: A or B.

Returned: <curve number>[term]

Format: nn (Refer to command for description)

INTYPE Input Type Parameter Command

Input: INTYPE <input>, <sensor type>, <compensation>[term]

Format: a,n,n

<input> Specifies input to configure: A or B.

<sensor type> Specifies input sensor type. Valid entries:

- | | |
|-------------------------------|------------------------|
| 0 = Silicon Diode | 5 = NTC RTD |
| 1 = GaAIAs Diode | 6 = Thermocouple 25 mV |
| 2 = 100 Ω Platinum/250 | 7 = Thermocouple 50 mV |
| 3 = 100 Ω Platinum/500 | 8 = 2.5 V, 1 mA |
| 4 = 1000 Ω Platinum | 9 = 7.5 V, 1 mA |

<compensation> Specifies input compensation where 0 = off and 1 = on. Reversal for thermal EMF compensation if input is resistive, room compensation if input is thermocouple. Always 0 if input is a diode.

Example: INTYPE A,0,0[term] – Sets Input A sensor type to silicon diode.

INTYPE? Input Type Parameter Query

Input: INTYPE? <input>[term]

Format: a

<input> Specifies input to query: A or B.

Returned: <sensor type>, <compensation>[term]

Format: n,n (Refer to command for description)

KEYST? Keypad Status Query

Input: KEYST? [term]

Returned: <keypad status>[term]

Format: n 1 = key pressed, 0 = no key pressed.

Remarks: Returns keypad status since the last KEYST?. KEYST? returns 1 after initial power-up.

KRDG? Kelvin Reading Query

Input: KRDG? <input>[term]

Format: a

<input> Specifies which input to query: A or B.

Returned: <kelvin value>[term]

Format: \pm nnnnnn

Remarks: Also see the RDGST? command.

LDAT? Linear Equation Data Query

Input: LDAT? <input>[term]

Format: a

<input> Specifies which input to query: A or B.

Returned: <linear value>[term]

Format: \pm nnnnnn

Remarks: Also see the RDGST? command.

LINEAR Input Linear Equation Parameter Command

Input: `LINEAR <input>, <equation>, <varM value>, <X source>, <B source>, <varB value>[term]`

Format: `a,n,±nnnnnn,n,n,±nnnnnn`

`<input>` Specifies input to configure: A or B.

`<equation>` Specifies linear equation to use.
Valid entries: 1 = (y = mx + b), 2 = (y = m(x + b)).

`<varM value>` Specifies a value for m in the equation.

`<X source >` Specifies input data to use. Valid entries: 1 = kelvin, 2 = Celsius, 3 = sensor units.

`<B source >` Specifies what to use for b in the equation. To use a setpoint, set its units to the same type specified in `<X source>`. Valid entries: 1 = a value, 2 = +SP1, 3 = -SP1, 4 = +SP2, 5 = -SP2.

`<varB value>` Specifies a value for b in the equation if `<B source>` is 1.

Example: `LINEAR A,1,1.0,1,3[term]` – The linear data for Input A is calculated from the kelvin reading of the input using the equation: $y = 1.0 * x - SP1$.

LINEAR? Input Linear Equation Parameter Query

Input: `LINEAR? <input> [term]`

Format: `a`

`<input>` Specifies which input to query: A or B.

Returned: `<equation>, <varM value>, <X source>, <B source>, <varB value>[term]`

Format: `n,±nnnnnn,n,n,±nnnnnn` (Refer to command for description)

Remarks: Returns input linear equation configuration.

LOCK Front Panel Keyboard Lock Command

Input: `LOCK <state>, <code> [term]`

Format: `n,nnn`

`<state>` 0 = Unlocked, 1 = Locked

`<code>` Specifies lock-out code. Valid entries are 000–999.

Remarks: Locks out all front panel entries except pressing the **Alarm** key to silence alarms and Heater Off to immediately turn off the heater output. Refer to Paragraph 4.17. Use the CODE command to set the lock code.

Example: `LOCK 1,123[term]` – Enables keypad lock and sets the code to 123.

LOCK? Front Panel Keyboard Lock Query

Input: `LOCK? [term]`

Returned: `<state>, <code>[term]`

Format: `n,nnn` (Refer to command for description)

MDAT? Minimum/Maximum Data Query

Input: `MDAT? <input> [term]`

Format: `a`

`<input>` Specifies which input to query: A or B.

Returned: `<min value>,<max value>[term]`

Format: `±nnnnnn,±nnnnnn`

Remarks: Returns the minimum and maximum input data. Also see the RDGST? command.

MNMX Minimum and Maximum Input Function Parameter Command

Input: **MNMX** <input>, <source> [term]

Format: a,n

<input> Specifies input to configure: A or B.

<source> Specifies input data to process through max/min. Valid entries: 1 = kelvin, 2 = Celsius, 3 = sensor units, 4 = linear data.

Example: **MNMX B,3[term]** – Input B min/max function is on and processes data from the input sensor units reading.

MNMX? Minimum and Maximum Input Function Parameter Query

Input: **MNMX?** <input> [term]

Format: a

<input> Specifies which input to query: A or B.

Returned: <source>[term]

Format: n (Refer to command for description)

MNMXRST Minimum and Maximum Function Reset Command

Input: **MNMXRST** [term]

Remarks: Resets the minimum and maximum data for all inputs.

MODE Remote Interface Mode Command

Input: **MODE** <mode> [term]

Format: n

<mode> 0 = local, 1 = remote, 2 = remote with local lockout.

Example: **MODE 2[term]** – Places the Model 331 into remote mode with local lockout.

MODE? Remote Interface Mode Query

Input: **MODE?** [term]

Returned: <mode>[term]

Format: n (Refer to command for description)

MOUT Control Loop Manual Heater Power (MHP) Output Command

Input: **MOUT** <loop>, <value> [term]

Format: n,±nnnnnn[term]

<loop> Specifies loop to configure: 1 or 2.

<value> Specifies value for manual output.

Example: **MOUT 1,22.45[term]** – Control Loop 1 manual heater power output is 22.45%.

MOUT? Control Loop Manual Heater Power (MHP) Output Query

Input: **MOUT?** <loop> [term]

Format: n

<loop> Specifies which loop to query: 1 or 2.

Returned: <value>

Format: ±nnnnnn[term] (Refer to command for description)

PID Control Loop PID Values Command

Input: PID <loop>, <P value>, <I value>, <D value>[term]

Format: n,±nnnnnn,±nnnnnn,±nnnnnn

- <loop> Specifies loop to configure: 1 or 2.
- <P value> The value for control loop Proportional (gain): 0.1 to 1000.
- <I value> The value for control loop Integral (reset): 0.1 to 1000.
- <D value> The value for control loop Derivative (rate): 0 to 200.

Remarks: Setting resolution is less than 6 digits indicated.

Example: PID 1,10,50[term] – Control Loop 1 P is 10 and I is 50.

PID? Control Loop PID Values Query

Input: PID? <loop>[term]

Format: n
 <loop> Specifies which loop to query: 1 or 2.

Returned: <P value>, <I value>, <D value>[term]

Format: ±nnnnnn,±nnnnnn,±nnnnnn (Refer to command for description)

RAMP Control Setpoint Ramp Parameter Command

Input: RAMP <loop>, <off/on>, <rate value>[term]

Format: n,n,±nnnnn
 <loop> Specifies which loop to configure: 1 or 2.
 <off/on> Specifies whether ramping is 0 = Off or 1 = On.
 <rate value> Specifies setpoint ramp rate in Kelvin per minute from 0.1 to 100. The rate is always positive, but will respond to ramps up or down.

Example: RAMP 1,1,10.5[term] – When Control Loop 1 setpoint is changed, ramp the current setpoint to the target setpoint at 10.5 K/minute.

RAMP? Control Setpoint Ramp Parameter Query

Input: RAMP? <loop>

Format: n
 <loop> Specifies which loop to query: 1 or 2.

Returned: <off/on>, <rate value>[term]

Format: n,±nnnnn (Refer to command for description)

RAMPST? Control Setpoint Ramp Status Query

Input: RAMPST? <loop>[term]

Format: n
 <loop> Specifies which loop to query: 1 or 2.

Returned: <ramp status>[term]

Format: n
 <ramp status> 0 = Not ramping, 1 = Setpoint is ramping.

RANGE Heater Range Command
Input: RANGE <range> [term]
Format: n 0 = Off, 1 = Low (0.5 W), 2 = Medium (5 W), 3 = High (50 W)

RANGE? Heater Range Query
Input: RANGE? [term]
Returned: <range>[term]
Format: n (Refer to command for description)

RDGST? Input Reading Status Query
Input: RDGST? <input> [term]
Format: a
 <input> Specifies which input to query: A or B.
Returned: <status bit weighting>[term]
Format: nnn
Remarks: The integer returned represents the sum of the bit weighting of the input status flag bits. A "000" response indicates a valid reading is present.

Bit	Bit Weighting	Status Indicator
0	1	invalid reading
4	16	temp underrange
5	32	temp overrange
6	64	sensor units zero
7	128	sensor units overrange

RELAY Relay Control Parameter Command
Input: RELAY <relay number>, <mode>, <input alarm>, <alarm type>[term]
Format: n,n,a,n
 <relay number> Specifies which relay to configure: 1 or 2.
 <mode> Specifies relay mode. 0 = Off, 1 = On, 2 = Alarms.
 <input alarm> Specifies which input alarm activates the relay when the relay is in alarm mode: A or B.
 <alarm type> Specifies the input alarm type that activates the relay when the relay is in alarm mode. 0 = Low alarm, 1 = High Alarm, 2 = Both Alarms.
Example: RELAY 1,2,B,0[term] – Relay 1 activates when Input B low alarm activates.

RELAY? Relay Control Parameter Query
Input: RELAY? <relay number> [term]
Format: n
 <relay number> Specifies which relay to query: 1 or 2.
Returned: n,a,n (Refer to command for description)

RELAYST? Relay Status Query
Input: RELAYST? <high/low>
Format: n
 <high/low> Specifies relay type to query: 1 = Low Alarm or 1 = High Alarm.
Returned: <status>[term]
Format: n 0 = Off, 1 = On.

REV? Input Firmware Revision Query

Input: REV? [term]

Returned: <revision>[term]

Format: n.n

Remarks: Returns the version number of the input firmware installed in the instrument.

SCAL Generate SoftCal Curve Command

Input: SCAL <std>, <dest>, <SN>, <T1 value>, <U1 value>, <T2 value>, <U2 value>, <T3 value>, <U3 value>[term]

Format: n,nn,aaaaaaaaa,±nnnnnn,±nnnnnn,±nnnnnn,±nnnnnn,±nnnnnn,±nnnnnn
 <std> Specifies the standard curve to generate a SoftCal from. Valid entries: 1, 6, 7.
 <dest> Specifies the user curve to store the SoftCal curve. Valid entries: 21 – 41.
 <SN> Specifies the curve serial number. Limited to 10 characters.
 <T1 value> Specifies first temperature point.
 <U1 value> Specifies first sensor units point.
 <T2 value> Specifies second temperature point.
 <U2 value> Specifies second sensor units point.
 <T3 value> Specifies third temperature point.
 <U3 value> Specifies third sensor units point.

Remarks: Generates a SoftCal curve. Refer to Paragraph 5.3.

Example: SCAL 1,21,1234567890,4.2,1.6260,77.32,1.0205,300.0,0.5189[term] – Generates a three-point SoftCal curve from standard curve 1 and saves it in user curve 21.

SETP Control Setpoint Command

Input: SETP <loop>, <value>[term]

Format: n,±nnnnnn
 <loop> Specifies which loop to configure.
 <value> The value for the setpoint (in whatever units the setpoint is using).

Example: SETP 1,122.5[term] – Control Loop 1 setpoint is now 122.5 (based on its units).

SETP? Control Setpoint Query

Input: SETP? <loop>[term]

Format: n
 <loop> Specifies which loop to query: 1 or 2.

Returned: <value>[term]

Format: ±nnnnnn

SRDG? Sensor Units Input Reading Query

Input: SRDG? <input>[term]

Format: a
 <input> Specifies which input to query: A or B.

Returned: <sensor units value>[term]

Format: ±nnnnnn

Remarks: Also see the RDGST? command.

TEMP? Thermocouple Junction Temperature Query

Input: TEMP?
Returned: <junction temperature>[term]
Format: ±nnnnnnn
Remarks: Temperature is in kelvin.

TUNEST? Control Tuning Status Query

Input: TUNEST?
Returned: <tuning status>[term]
Format: n 0 = no active tuning, 1 = active tuning.

ZONE Control Loop Zone Table Parameter Command

Input: ZONE <loop>, <zone>, <top value>, <P value>, <I value>, <D value>, <mout value>, <range>[term]
Format: n,nn,±nnnnnn,±nnnnnn,±nnnnnn,±nnnnnn,±nnnnnn,n[term]
 <loop> Specifies which loop to configure: 1 or 2.
 <zone> Specifies which zone in the table to configure. Valid entries are: 1 – 10.
 <top value> Specifies the top temperature of this zone.
 <P value> Specifies the P for this zone: 0.1 to 1000.
 <I value> Specifies the I for this zone: 0.1 to 1000.
 <D value> Specifies the D for this zone: 0 to 200%.
 <mout value> Specifies the manual output for this zone: 0 to 100%.
 <range> Specifies the heater range for this zone if <loop> = 1. Valid entries: 0 – 3.
Remarks: Configures the control loop zone parameters. Refer to Paragraph 2.9.
Example: ZONE 1,1,25.0,10,20,0,0,2[term] – Control Loop 1 zone 1 is valid to 25.0 K with P = 10, I = 20, D = 0, and a heater range of 2.

ZONE? Control Loop Zone Table Parameter Query

Input: ZONE? <loop>, <zone> [term]
Format: n,nn
 <loop> Specifies which loop to query: 1 or 2.
 <zone> Specifies which zone in the table to query. Valid entries: 1 – 10.
Returned: <top value>, <P value>, <I value>, <D value>, <mout value>, <range>[term]
Format: ±nnnnnn,±nnnnnn,±nnnnnn,±nnnnnn,±nnnnnn,n (Refer to command for description)

This Page Intentionally Left Blank

CHAPTER 7

OPTIONS AND ACCESSORIES

7.0 GENERAL

This chapter provides Model 331 Temperature Controller options and accessories. Model numbers are detailed in Paragraph 7.1, options in Paragraph 7.2, accessories in Paragraph 7.3, and the Model 3003 Heater Output Conditioner in Paragraph 7.4.

7.1 MODELS

The list of Model 331 Model Numbers is provided as follows.

<i>Model</i>	<i>Description Of Models</i>
331S	<p>Standard Temperature Controller. Includes all features. Model numbers as follows:</p> <p>331S.....Two Diode/Resistor Inputs.</p> <p>331S-T1One Diode/Resistor, One Thermocouple Input.</p> <p>331S-T2Two Thermocouple Inputs.</p>
331E	<p>Economy Temperature Controller. Includes all features of the Model 331S except Relays and Analog Output (2nd control loop) and IEEE-488 Interface. Model numbers as follows:</p> <p>331E.....Two Diode/Resistor Inputs.</p> <p>331E-T1One Diode/Resistor, One Thermocouple Inputs.</p> <p>331E-T2Two Thermocouple Inputs.</p>

Power Configurations. The instrument is configured at the factory for customer-selected power as follows:

VAC-100	Instrument configured for 100 VAC with U.S. Power Cord.
VAC-120	Instrument configured for 120 VAC with U.S. Power Cord.
VAC-220	Instrument configured for 220 VAC with Universal European line cord.
VAC-240	Instrument configured for 240 VAC with Universal European line cord.
VAC-120-ALL	Instrument configured for 120 VAC with U.S. Power Cord and universal European line cord and fuses for 220/240 setting.

7.2 OPTIONS

The list of Model 331 options is provided as follows.

<i>Model</i>	<i>Description Of Options</i>
8000	<p>CalCurve™ on CD or E-Mail. The Model 8000 CalCurve is offered on CD or via e-mail free of charge at time of order to any customer who orders a calibrated sensor. The Model 8000 consists of calibration breakpoint interpolation data stored in ASCII format. Also included is a PC executable program to load the data into a Lake Shore Instrument via IEEE-488 or RS-232 Interface. Once loaded, the instrument uses the data to calculate and display temperature. The following information is included: raw data, coefficients, interpolation table, instrument breakpoints, LSCurves.exe DOS-based program, and Readme.txt describing the file formats.</p>
8001-331	<p>CalCurve™, Factory Installed. Provides users with a convenient method of storing sensor calibrations within Lake Shore Instruments. Calibration data (breakpoint interpolation table) for a specific sensor is stored into a nonvolatile memory.</p>
8002-05-331	<p>CalCurve™, Field Installation. For users who already own a Model 331. When ordering, please specify your instrument serial number and calibrated sensor model and serial number. A new NOVRAM will be sent for Customer installation.</p>

7.3 ACCESSORIES

Accessories are devices that perform a secondary duty as an aid or refinement to the primary unit. Refer to the Lake Shore Temperature Measurement and Control Catalog for details. A list of accessories available for the Model 331 is as follows:

<i>Model</i>	<i>Description Of Accessories</i>
106-009 *	Heater Output Connector. Dual banana jack for Heater Output.
G-106-233 *	Sensor Input Mating Connector. 6-pin DIN plug for Diode/Resistor Input; 2 included.
106-739 *	Terminal Block Mating Connector. 8-pin terminal block for Relays and Analog Output.
112-334	Model 331/332 Sensor/Heater Cable Assembly - 10'. Cable assembly for 2 diode/resistor sensors and Loop 1 heater. Approximately 3 meters (10 feet) long. See Figure 7-1.
112-335	Model 331/332 Sensor/Heater Cable Assembly - 20'. Cable assembly for 2 diode/resistor sensors and Loop 1 heater. Approximately 6 meters (20 feet) long. See Figure 7-1.
115-006 *	Detachable 120 VAC Line Cord.
3003	Heater Output Conditioner. The heater output conditioner is a passive filter which further reduces the already low heater output noise of the Model 331. For details, refer to Paragraph 7.4 and see Figure 7-2.
4005	IEEE-488 Cable Kit. One meter (3 feet) long IEEE-488 (GPIB) computer interface cable. Includes extender required to use both IEEE cable and relay terminal block simultaneously.
CAL-331-CERT	Instrument recalibration with certificate.
CAL-331-DATA	Instrument recalibration with certificate and data.
ES-2-20	Stycast[®] Epoxy 2850-FT, Catalyst 9 (20 packets, 2 grams each). Stycast is a common, highly versatile, nonconductive epoxy resin system for cryogenic use. The primary use for Stycast is for vacuum feedthroughs or permanent thermal anchors. Stycast is an alternative to Apiezon N Grease when permanent sensor mountings are desired.
ID-10-XX	Indium Solder Disks (Quantity 10). Indium is a semi-precious non-ferrous metal, softer than lead, and extremely malleable and ductile. It stays soft and workable down to cryogenic temperatures. Indium can be used to create solder "bumps" for microelectronic chip attachments and also as gaskets for pressure and vacuum sealing purposes. ID-10-31 Indium Disks are 0.312 diameter × 0.005 inches. ID-10-56 Indium Disks are 0.562 diameter × 0.005 inches.
IF-5	Indium Foil Sheets (Quantity 5). When used as a washer between DT-470-CU silicon diode or other temperature sensors and refrigerator cold stages, indium foil increases the thermal contact area and prevents the sensor from detaching due to vibration. It also may be used as a sealing gasket for covers, flanges, and windows in cryogenic applications. Each sheet is 0.005 × 2 × 2 inches.
GAH-25	Apiezon[®] "H" Grease, 25 gram Tube. It is designed for general purposes where operating temperatures necessitate the use of a relatively high melting point grease. Melting point is ≈523 K (250 °C). Can be removed using Xylene with an Isopropyl alcohol rinse.

* Accessories included with a new Model 331.

Accessories (Continued)

Model	Description Of Accessories (Continued)
GAN-25	Apiezon® “N” Grease, 25 gram Tube. General purpose grease well-suited for cryogenic use because of its low viscosity. It is often used as a means of thermally anchoring cryogenic sensors as well as lubricating joints and o-rings. Contains high molecular weight polymeric hydrocarbon additive which gives it a tenacious, rubbery consistency allowing the grease to form a cushion between mating surfaces. Melting point is ≈ 316 K (43 °C). Can be removed using Xylene with an Isopropyl alcohol rinse.
HTR-25	25 Ω Cartridge Heater. The heater features precision-wound nickel-chromium resistance wire, magnesium oxide insulation, two solid pins, non-magnetic package, and has UL and CSA component recognition. The heater is 25 W, 6.35 mm (0.25 inch) diameter by 25.4 mm (1 inch) long. The 25 W rating is in dead air. With proper heat sinking, the cartridge heater can handle many times this dead air power rating.
HTR-50	50 Ω Cartridge Heater. The heater features precision-wound nickel-chromium resistance wire, magnesium oxide insulation, two solid pins, non-magnetic package, and has UL and CSA component recognition. The heater is 50 W, 6.35 mm (0.25 inch) diameter by 25.4 mm (1 inch) long. The 50 W rating is in dead air. With proper heat sinking, the cartridge heater can handle many times this dead air power rating.
MAN-331*	Model 331 Temperature Controller User's Manual.
RM-1/2	Half-Rack Mounting Kit for One Model 331 Temperature Controller. Half-length mounting panel and mounting ears to attach one Model 331 to a 483 mm (19-inch) rack mount space. See Figure 7-3.
RM-2	Dual Mounting Shelf for Two Model 331 Temperature Controllers. Mounting shelf to attach any two 5.25-inch tall half-rack instruments side-by-side on a 483 mm (19-inch) rack mount shelf. See Figure 7-4.
VGE-7031	IMI-7031 Varnish (formerly GE 7031 Varnish) (1 pint can). IMI-7031 Insulating Varnish and Adhesive possesses electrical and bonding properties which, when combined with its chemical resistance and good saturating properties, make it an excellent material for cryogenic temperatures. As an adhesive, IMI-7031 bonds a variety of materials, has fast tack time, and may be air dried or baked. It is also an electrically insulating adhesive at cryogenic temperatures and is often used as a calorimeter cement. When soaked into cigarette paper, it makes a good, high thermal conductivity, low electrical conductivity heat sinking layer. Maximum operating temperature: 423 K (150 °C).
Wire	Lake Shore Cryogenic Wire. Lake Shore sells the following types of cryogenic wire: DT = Duo-Twist™, MN = Single Strand, MW = Manganin, NC = Nichrome Heater, ND = Heavy Duty, QL = Quad-Lead™, and QT = Quad-Twist™. Lake Shore Coaxial Cable. Lake Shore sells the following types of coaxial cable: CC = Ultra Miniature Coaxial Cable, SR = Semi-Rigid Coaxial Cable, CRYC = CryoCable™.

* Accessories included with a new Model 331.

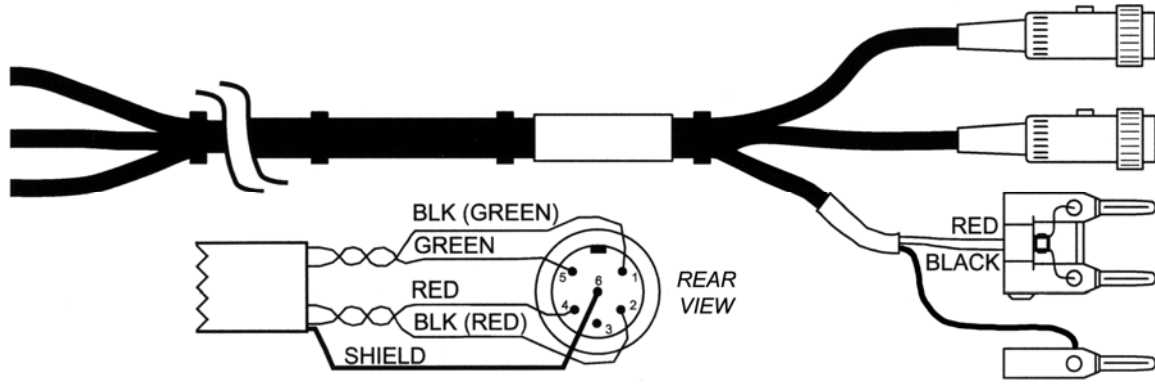

112-334.bmp

Figure 7-1. Model 331 Sensor and Heater Cable Assembly
 10' - P/N 112-334, 20' - P/N 112-334

7.4 MODEL 3003 HEATER OUTPUT CONDITIONER

The Lake Shore Model 3003 Heater Output Conditioner is a passive filter which reduces the already low noise present in the heater output of the Model 331. The Model 3003 connects between the heater output terminals on the rear panel of a controller and a resistive heater. See Figure 7-2.

Specifications are as follows:

- Max Current: 2 A
- Max Voltage: 60 V
- Attenuation: 50 or 60 Hz (line frequency): 20 dB
 100 Hz and above (line frequency harmonics): 40 dB
- Enclosure Size: 144 mm wide × 72 mm long × 165 mm deep (5.7 × 2.8 × 6.5 inches)
- Weight: 1.6 kilograms (3.5 pounds)

The Model 3003 is a passive filter and requires no external power supply. The **High** and **Low** terminals on the controller must be connected to the **High** and **Low** terminals marked *From Controller* on the Model 3003. The binding posts or a dual banana plug can be used to connect to the model 3003. Precautions must be taken to ensure the High and Low terminals are not reversed. A diode in the Model 3003 shorts the heater output if the polarity of the terminals is reversed.

The **High** and **Low** terminals marked *To Heater* on the Model 3003 should be attached to a resistive heater used for temperature control. The binding posts or a dual banana plug can be used to connect to the Model 3003. The ground terminals on the Model 3003 continue the shield if the heater cable is shielded.

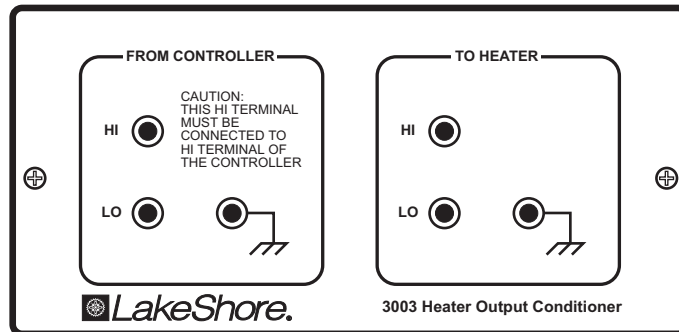

F-331-7-2.eps

Figure 7-2. Model 3003 Heater Output Conditioner

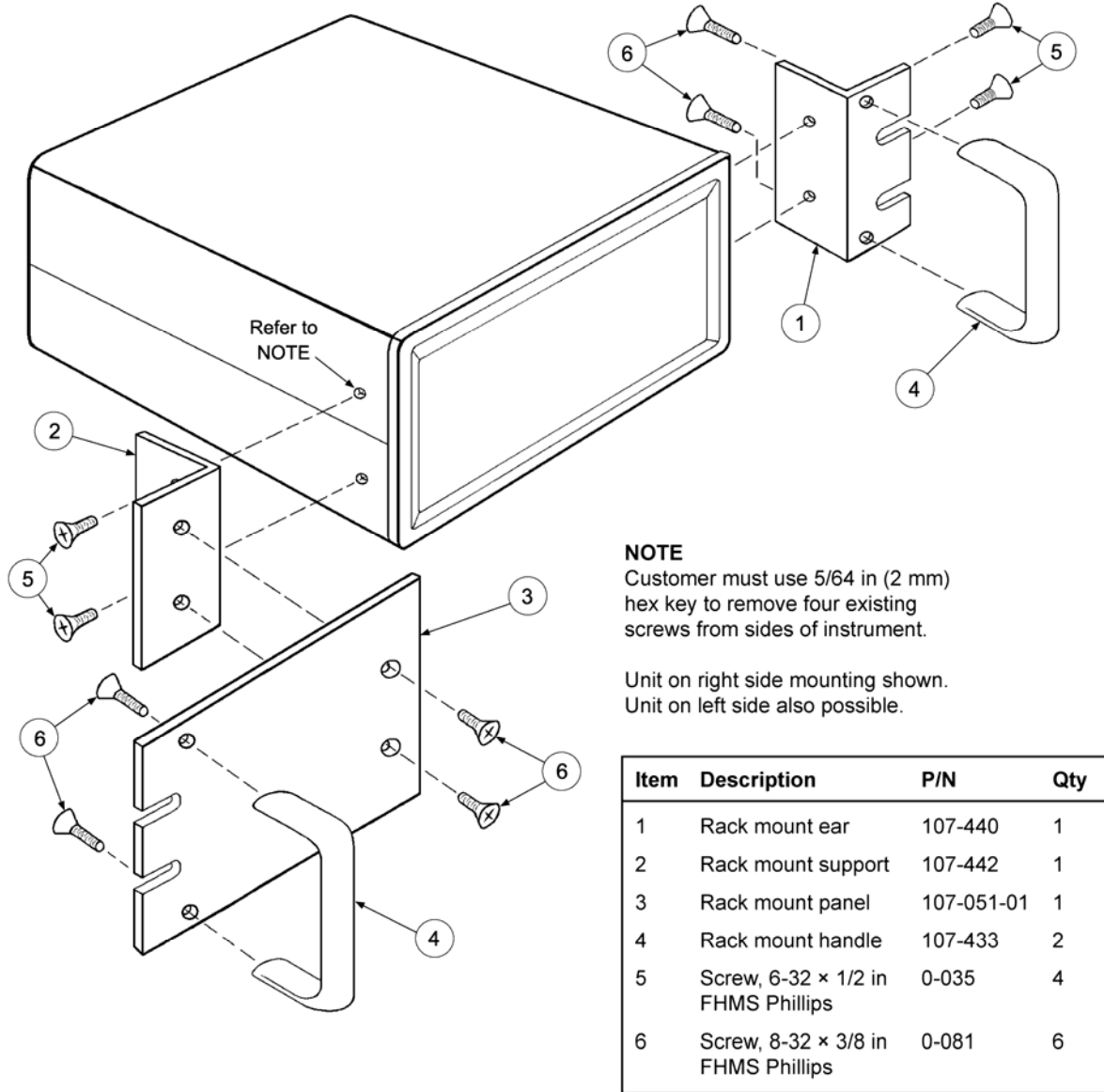

P-331-7-3.bmp

Figure 7-3. Model RM-1/2 Rack-Mount Kit

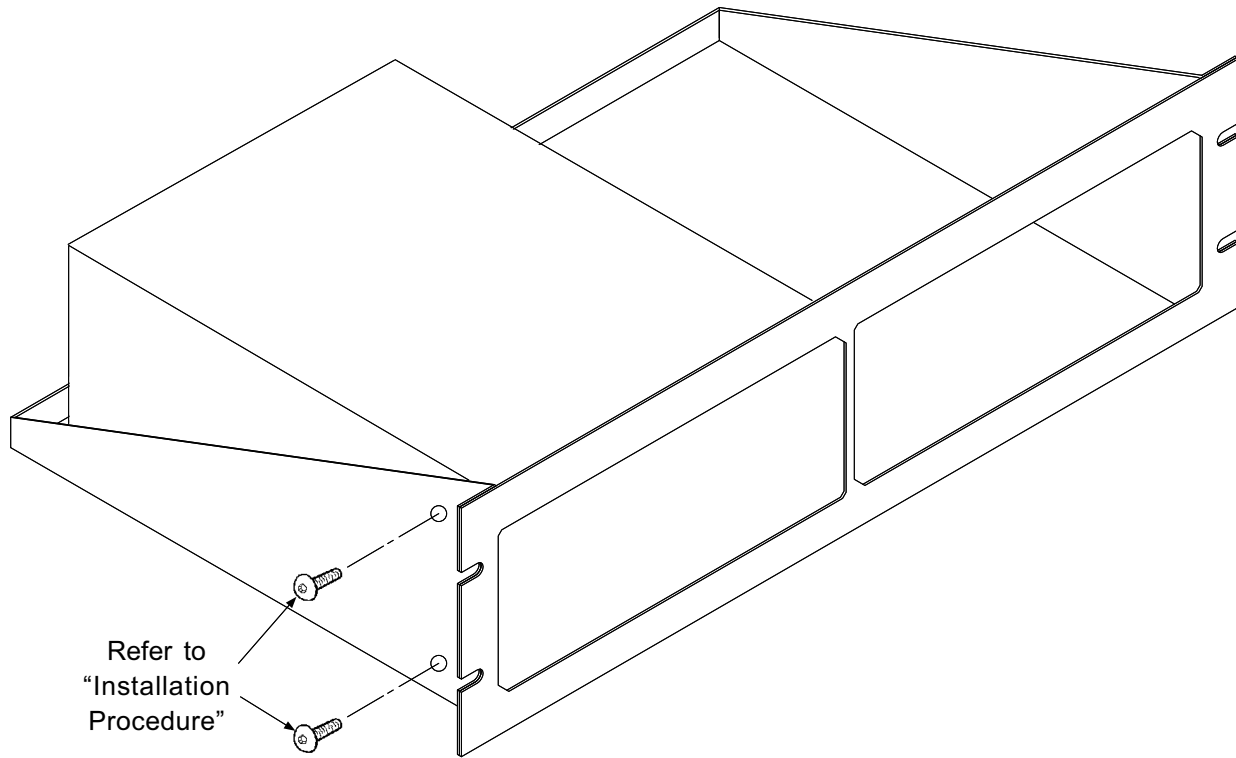

Installation Procedure

1. Use 5/64 inch (2 mm) hex key to remove two 6-32 x 1/4 black button head screws from side of instrument.
2. Place Instrument on shelf.
3. Use 5/64 inch (2 mm) hex key to reinstall two 6-32 x 1/4 black button head screws through side of rack into corresponding holes in the side of the instrument.

C-331-7-4.eps

Figure 7-4. Model RM-2 Dual Rack-Mount Shelf

CHAPTER 8

SERVICE

8.0 GENERAL

This chapter describes the service for the Model 331 Temperature Controller. Paragraph 8.1 provides a description of Electrostatic Discharge (ESD), line voltage selection in Paragraph 8.2, fuse replacement in Paragraph 8.3, rear panel connector definitions in Paragraph 8.4, top of enclosure remove and replace procedure in Paragraph 8.5, firmware and NOVRAM replacement in Paragraph 8.6, jumpers in Paragraph 8.7, error messages in Paragraph 8.8, and calibration procedure in Paragraph 8.9.

8.1 ELECTROSTATIC DISCHARGE

Electrostatic Discharge (ESD) may damage electronic parts, assemblies, and equipment. ESD is a transfer of electrostatic charge between bodies at different electrostatic potentials caused by direct contact or induced by an electrostatic field. The low-energy source that most commonly destroys Electrostatic Discharge Sensitive (ESDS) devices is the human body, which generates and retains static electricity. Simply walking across a carpet in low humidity may generate up to 35,000 volts of static electricity.

Current technology trends toward greater complexity, increased packaging density, and thinner dielectrics between active elements, which results in electronic devices with even more ESD sensitivity. Some electronic parts are more ESDS than others. ESD levels of only a few hundred volts may damage electronic components such as semiconductors, thick and thin film resistors, and piezoelectric crystals during testing, handling, repair, or assembly. Discharge voltages below 4000 volts cannot be seen, felt, or heard.

8.1.1 Identification of Electrostatic Discharge Sensitive Components

The following are various industry symbols used to label components as ESDS.



8.1.2 Handling Electrostatic Discharge Sensitive Components

Observe all precautions necessary to prevent damage to ESDS components before attempting installation. Bring the device and everything that contacts it to ground potential by providing a conductive surface and discharge paths. As a minimum, observe these precautions:

1. De-energize or disconnect all power and signal sources and loads used with unit.
2. Place unit on a grounded conductive work surface.
3. Ground technician through a conductive wrist strap (or other device) using 1 M Ω series resistor to protect operator.
4. Ground any tools, such as soldering equipment, that will contact unit. Contact with operator's hands provides a sufficient ground for tools that are otherwise electrically isolated.
5. Place ESDS devices and assemblies removed from a unit on a conductive work surface or in a conductive container. An operator inserting or removing a device or assembly from a container must maintain contact with a conductive portion of the container. Use only plastic bags approved for storage of ESD material.
6. Do not handle ESDS devices unnecessarily or remove from the packages until actually used or tested.

8.2 LINE VOLTAGE SELECTION

Use the following procedure to change the instrument line voltage selector. Verify the fuse value whenever line voltage is changed.

WARNING: To avoid potentially lethal shocks, turn off controller and disconnect it from AC power before performing these procedures.

1. Identify the line input assembly on the instrument rear panel. See Figure 8-1.
2. Turn the line power switch OFF (O).
3. Remove the instrument power cord.
4. With a small screwdriver, release the drawer holding the line voltage selector and fuse.
5. Slide out the removable plastic fuse holder from the drawer.
6. Rotate the fuse holder until the proper voltage indicator shows through the window.
7. Verify the proper fuse value.
8. Re-assemble the line input assembly in the reverse order.
9. Verify the voltage indicator in the window of the line input assembly.
10. Connect the instrument power cord.
11. Turn the line power switch On (I).

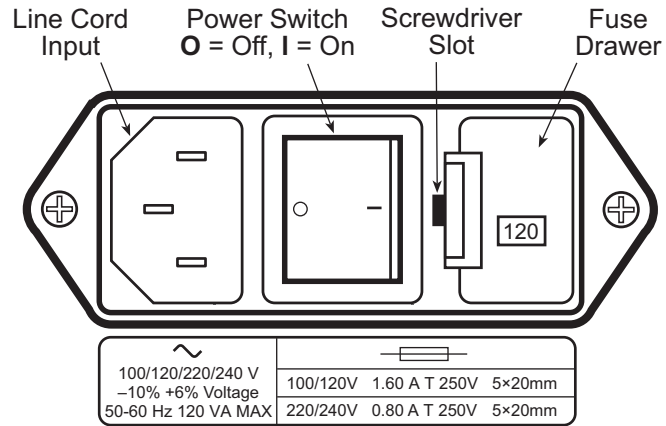

F-331-8-1.eps

Figure 8-1. Power Fuse Access

8.3 FUSE REPLACEMENT

Use the following procedure to remove and replace a line fuse.

WARNING: To avoid potentially lethal shocks, turn off controller and disconnect it from AC power before performing these procedures.

CAUTION: For continued protection against fire hazard, replace only with the same fuse type and rating specified for the line for the line voltage selected.

NOTE: Test fuse with an ohmmeter. Do not rely on visual inspection of fuse.

1. Locate line input assembly on the instrument rear panel. See Figure 8-1.
2. Turn power switch Off (O).
3. Remove instrument power cord.
4. With a small screwdriver, release the drawer holding the line voltage selector and fuse.

5. Remove and discard both existing fuses. Replace with proper Slow-Blow (time-delay) fuse ratings as follows:

100/120 V	1.60 A T 250 V	5 × 20 mm
220/240 V	0.80 A T 250 V	5 × 20 mm

6. Re-assemble line input assembly in reverse order.
7. Verify voltage indicator in the line input assembly window.
8. Connect instrument power cord.
9. Turn power switch On (I).

8.4 REAR PANEL CONNECTOR DEFINITIONS

The Sensor Input, Heater Output, Relays and Analog Output, and RS-232 connectors are defined in Figures 8-2 thru 8-5. For thermocouple connector details, refer to Figure 3-4.

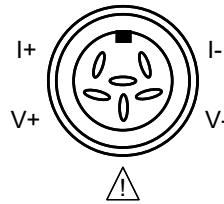

C331-8-2.eps

Pin	Symbol	Description
1	I-	- Current
2	V-	- Voltage
3	⚠	+1 mA – Model 330 Configuration Shield – Model 340 Configuration Refer to Paragraph 8.8 for jumper settings that determine the output of this pin and to Paragraph 3.5.1 for a general explanation.
4	V+	+ Voltage
5	I+	+ Current
6	None	Shield

Figure 8-2. Sensor INPUT A and B Connector Details

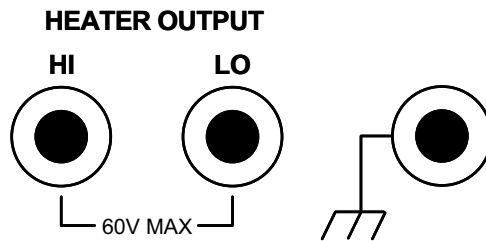

C-331-8-3.eps

Pin	Description
1	HI (Banana)
2	LO (Banana)
3	Ground (Banana)

Figure 8-3. HEATER OUTPUT Connector Details

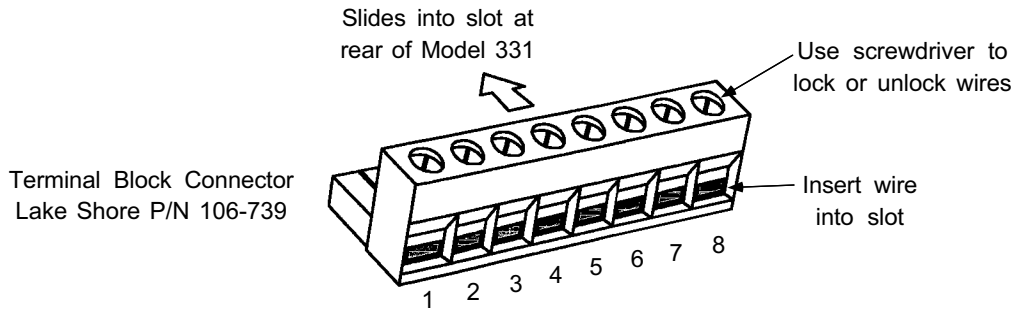

C-331-8-4.eps

Pin	Description
1	Relay 1 – Normally Closed (NC)
2	Relay 1 – Common (COM)
3	Relay 1 – Normally Open (NO)
4	Relay 2 – Normally Close (NC)
5	Relay 2 – Common (COM)
6	Relay 2 – Normally Open (NO)
7	Analog Voltage Output – Hi (+)
8	Analog Voltage Output – Lo (-)

Figure 8-4. RELAYS and ANALOG OUPUT Terminal Block

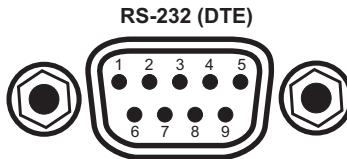

F-331-8-5.eps

Model 331 Temperature Controller		Typical Computers			
DE-9P (DTE)		DB-25P (DTE)		DE-9P (DTE)	
Pin	Description	Pin	Description	Pin	Description
1	No Connection	2	TD (out)	1	DCD (in)
2	Receive Data (RD in)	3	RD (in)	2	RD (in)
3	Transmit Data (TD out)	4	RTS (out)	3	TD (out)
4	Data Terminal Ready (DTR out)	5	CTS (in)	4	DTR (out)
5	Ground (GND)	6	DSR (in)	5	GND
6	Data Set Ready (DSR in)	7	GND	6	DSR (in)
7	Data Terminal Ready (DTR out) (tied to 4)	8	DCD (in)	7	RTS (out)
8	No Connection	20	DTR (out)	8	CTS (in)
9	No Connection	22	Ring in (in)	9	Ring in (in)

Figure 8-5. RS-232 Connector Details

8.4.1 Serial Interface Cable Wiring

The following are suggested cable wiring diagrams for connecting the Model 331 Serial Interface to various Customer Personal Computers (PCs).

Model 331 to PC Serial Interface – PC with DE-9P

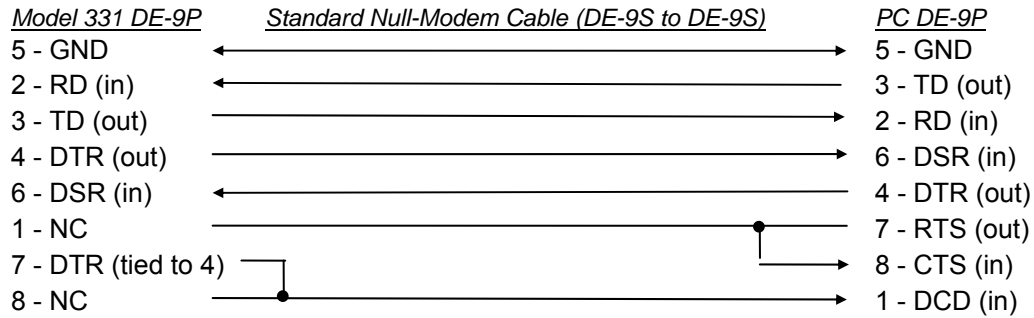

Model 331 to PC Serial Interface – PC with DB-25P

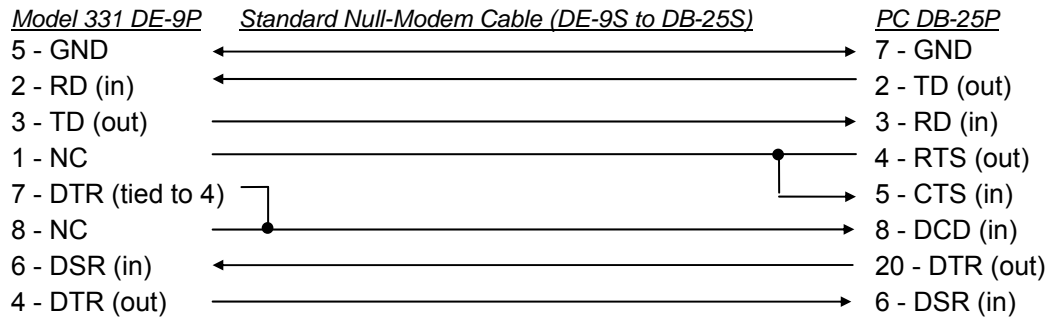

Model 331 to PC Interface using Null Modem Adapter

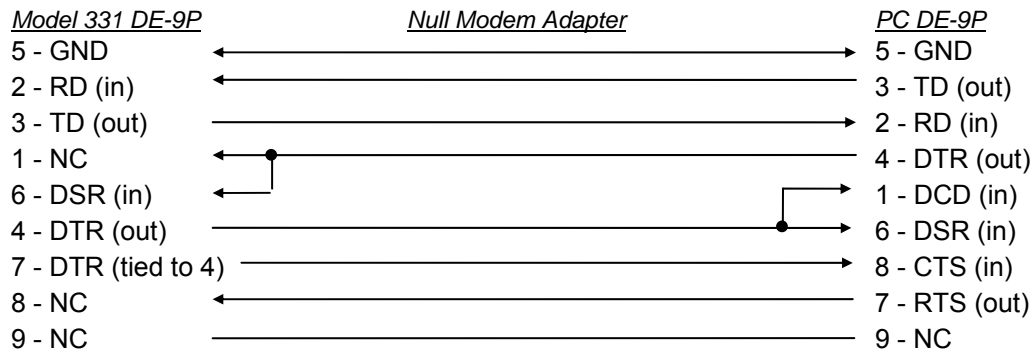

NOTE: Same as null modem cable design except PC CTS is provided from the Model 331 on DTR.

8.4.2 IEEE-488 Interface Connector

Connect to the IEEE-488 Interface connector on the Model 331 rear with cables specified in the IEEE-488-1978 standard document. The cable has 24 conductors with an outer shield. The connectors are 24-way Amphenol 57 Series (or equivalent) with piggyback receptacles to allow daisy-chaining in multiple device systems. The connectors are secured in the receptacles by two captive locking screws with metric threads.

The total length of cable allowed in a system is 2 meters for each device on the bus, or 20 meters maximum. The Model 331 can drive a bus of up to 10 devices. A connector extender is required to use the IEEE-488 Interface and Relay Terminal Block at the same time. Figure 8-6 shows the IEEE-488 Interface connector pin location and signal names as viewed from the Model 331 rear panel.

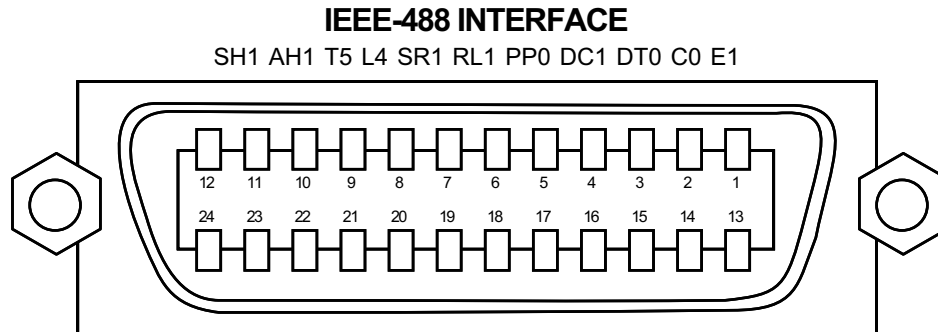

C-331-8-6.eps

PIN	SYMBOL	DESCRIPTION
1	DIO 1	Data Input/Output Line 1
2	DIO 2	Data Input/Output Line 2
3	DIO 3	Data Input/Output Line 3
4	DIO 4	Data Input/Output Line 4
5	EOI	End Or Identify
6	DAV	Data Valid
7	NRFD	Not Ready For Data
8	NDAC	Not Data Accepted
9	IFC	Interface Clear
10	SRQ	Service Request
11	ATN	Attention
12	SHIELD	Cable Shield
13	DIO 5	Data Input/Output Line 5
14	DIO 6	Data Input/Output Line 6
15	DIO 7	Data Input/Output Line 7
16	DIO 8	Data Input/Output Line 8
17	REN	Remote Enable
18	GND 6	Ground Wire – Twisted pair with DAV
19	GND 7	Ground Wire – Twisted pair with NRFD
20	GND 8	Ground Wire – Twisted pair with NDAC
21	GND 9	Ground Wire – Twisted pair with IFC
22	GND 10	Ground Wire – Twisted pair with SRQ
23	GND 11	Ground Wire – Twisted pair with ATN
24	GND	Logic Ground

Figure 8-6. IEEE-488 Rear Panel Connector Details

8.5 TOP OF ENCLOSURE REMOVE AND REPLACE PROCEDURE

WARNING: To avoid potentially lethal shocks, turn off controller and disconnect it from AC power line before performing this procedure. Only qualified personnel should perform this procedure.

REMOVAL

1. Set power switch to Off (O) and disconnect power cord from rear of unit.
2. If attached, remove 19-inch rack mounting brackets.
3. Use 5/64 hex key to remove four screws attaching top panel to unit.
4. Use 5/64 hex key to loosen two rear screws attaching bottom panel to unit.
5. Carefully remove the back bezel by sliding it straight back away from the unit.
6. Slide the top panel back and remove it from the unit.

INSTALLATION

1. Slide the top panel forward in the track provided on each side of the unit.
2. Carefully replace the back bezel by sliding it straight into the unit.
3. Use 5/64 hex key to install four screws attaching top panel to unit.
4. Use 5/64 hex key to tighten two rear screws attaching bottom panel to unit.
5. If required, reattach 19-inch rack mounting brackets.
6. Connect power cord to rear of unit and set power switch to On (I).

8.6 FIRMWARE AND NOVRAM REPLACEMENT

There are three integrated circuits (ICs) that may potentially require replacement. The location of the ICs is shown in Figure 8-7.

- Input Microcontroller (U16) – Contains software that configures the inputs, takes readings, and performs control functions. Has a sticker on top labeled “M3311F.HEX” and a version number.
- Main Firmware Erasable Programmable Read Only Memory (EPROM) (U22) – Contains the user interface software. Has a sticker on top labeled “M331F.HEX” and a date.
- Non-Volatile Random Access Memory (NOVRAM) (U23) – Contains instrument settings and user curves. The NOVRAM is replaced when the customer purchases a Model 8002-05-331 CalCurve™. Refer to Paragraph 7.2.

Use the following procedure to replace any of these ICs.

1. Follow the top of enclosure *REMOVAL* procedure in Paragraph 8.5.
2. Locate the IC on the main circuit board. See Figure 8-7. Note orientation of existing IC.

CAUTION: The ICs are Electrostatic Discharge Sensitive (ESDS) devices. Wear shock-proof wrist straps (resistor limited to <5 mA) to prevent injury to service personnel and to avoid inducing an Electrostatic Discharge (ESD) into the device.

3. Use IC puller to remove existing IC from the socket.
4. Noting orientation of new IC, use an IC insertion tool to place new device into socket.

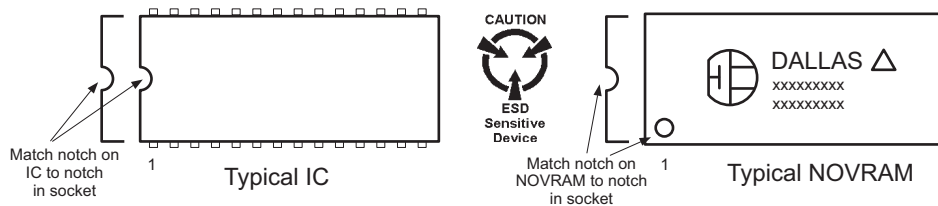

Eprom.eps

5. Follow the top of enclosure *INSTALLATION* procedure in Paragraph 8.5.

8.7 JUMPERS

There are seven jumpers located on the main circuit board of the Model 331. See Figure 8-7 for the location of the jumpers (reference designators JMP1 thru JMP7).

CAUTION: Only JMP4 and JMP7 should be changed by the user. Please consult with Lake Shore before changing any of the other jumpers.

Reference Designator	Silkscreen	Default	Description
JMP1	RUN / TEST	RUN	Used for diagnostic purposes only.
JMP2	RS-485 / RS-232	RS-232	Serial Interface mode. RS-485 is not supported.
JMP3	IEEE SHIELD	Not Used	Used for ground loop testing.
JMP4	330 / 340	330	Set at factory to reflect configuration of Input A where 330 = 1 mA excitation current on Pin 3 of the connector and 340 = Pin 3 connected to shield. Refer to Paragraph 3.5.1.
JMP5	DI/RE / TC	—	Set at factory to reflect configuration of Input A where DI/RE = diode/resistor and TC = thermocouple.
JMP6	DI/RE / TC	—	Set at factory to reflect configuration of Input B where DI/RE = diode/resistor and TC = thermocouple.
JMP7	330 / 340	330	Set at factory to reflect configuration of Input B where 330 = 1 mA excitation current on Pin 3 of the connector and 340 = Pin 3 connected to shield. Refer to Paragraph 3.5.1.

8.8 ERROR MESSAGES

The following are error message that may be displayed by the Model 331 during operation.

Message	Description
Disabled	Input is turned off.
No Curve	Input has no curve.
S. Over	Input is at or over full-scale sensor units.
S. Under	Input is at or under negative full-scale sensor units.
T. Over	Input at or over the high end of the curve.
T. Under	Input at or under the low end of the curve.
HTR Open	No heater load is connected to the rear panel heater terminals. Most commonly repaired by checking the heater connections. May also be caused by a loose connection or malfunctioning component within the instrument.
HTR Fail	Internal component malfunction. Contact Lake Shore.
Defective NOVRAM	Defective NOVRAM. Contact Lake Shore.
Invalid NOVRAM	Invalid data or contents in NOVRAM – Press and hold the Escape key for ≈20 seconds to initialize NOVRAM. Refer to Paragraph 4.21.

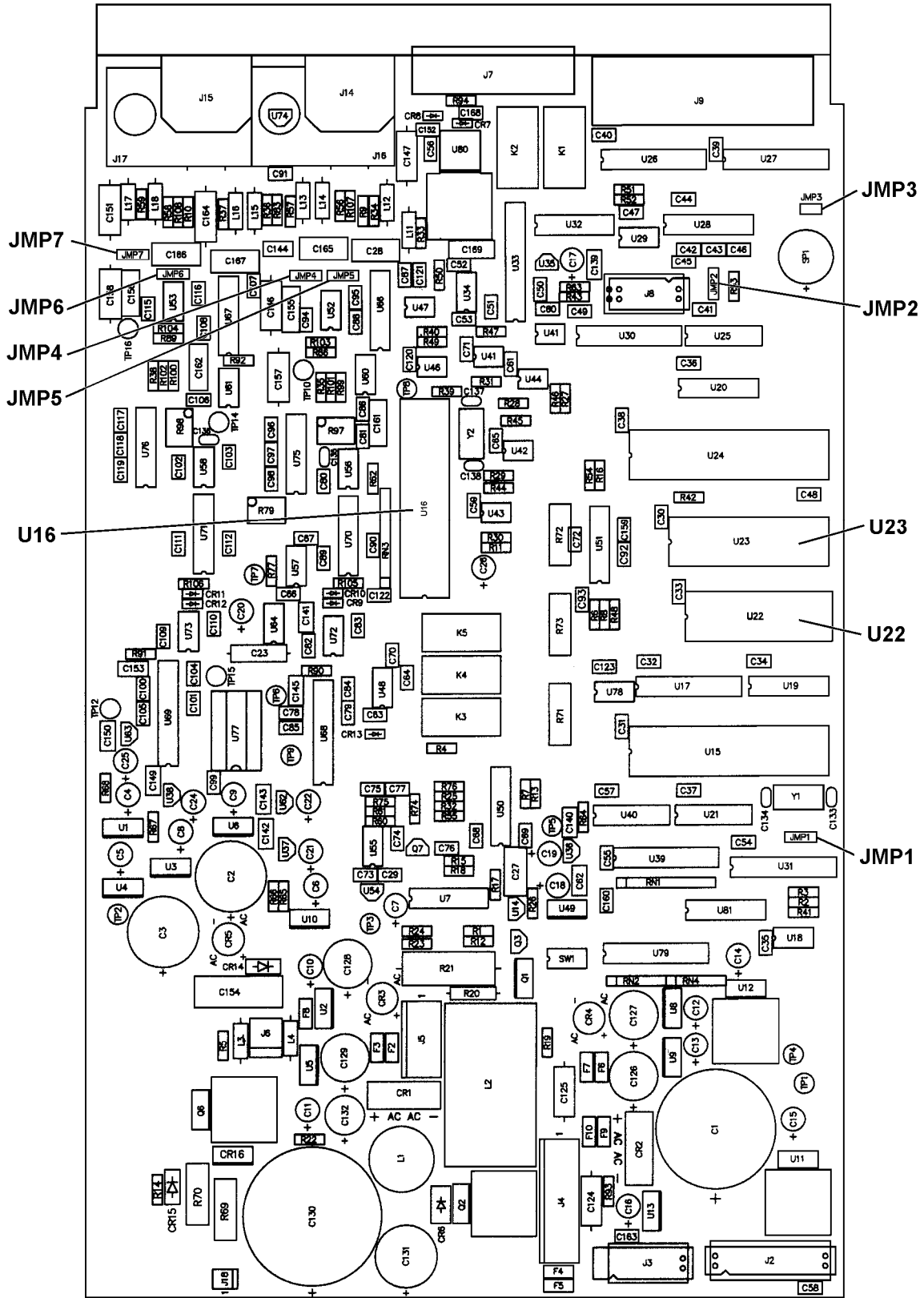

P-331-8-7.bmp

Figure 8-7. Location Of Internal Components

8.9 CALIBRATION PROCEDURE

The Model 331 requires calibration of both of the sensor inputs and analog output to operate within specification. None of the other circuits require calibration. The sensor inputs may be configured as diode/resistor or thermocouple and the calibration process differs for each. This procedure contains instructions for both input types. The analog output calibration is necessary for the Model 331S only and may be ignored for the Model 331E. Refer to Paragraph 8.9.5 for details on calibration specific interface commands.

8.9.1 Equipment Required for Calibration

PC and Interface

- PC with software loaded which provides serial command line communication. (Example program in Paragraph 6.2.7 is ideal for this purpose.)
- DE-9 to DE-9 cable. Pin to pin connections on all 9 pins. Female connectors on both ends.
- DE-9 null modem adapter.

Test and Measurement Equipment

- Digital Multimeter (DMM) with minimum of 6-digits resolution. DMM DC voltage and 4-lead resistance specifications to be equivalent to or better than HP 3458A specifications.
- Precision reference providing up to ± 7.5 V with 1 mV resolution for Diode/Resistor input calibration.
- Precision reference providing up to ± 50 mV with 1 μ V resolution for Thermocouple input calibration.

Calibration Cables

- Diode/Resistor Calibration Cable (1 required if single or dual Diode/Resistor unit)

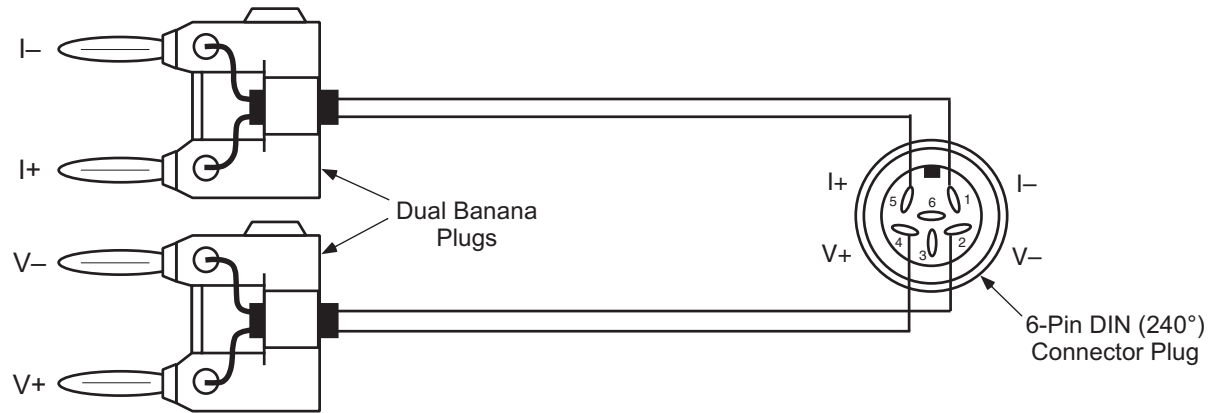

- Thermocouple Calibration Cable (1 required if single or dual Thermocouple unit)

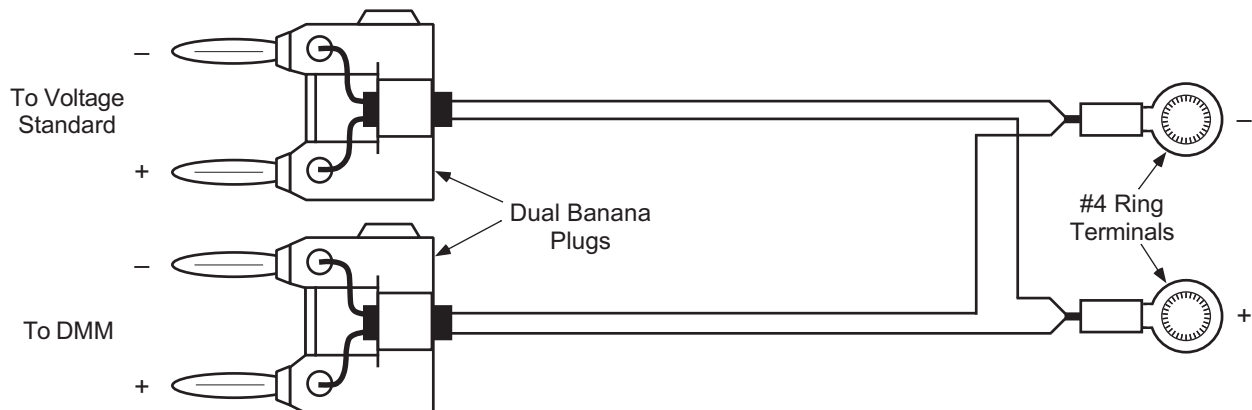

Equipment Required for Calibration (Continued)**Resistor Standards**

- Resistor standards with the following nominal values. If standards are not available, ¼ W 25ppm/°C metal film resistors can be used. They should have connectors attached to mate with two dual banana plugs for 4-lead measurement.
- 0 Ω (short), 10 Ω, 100 Ω, 500 Ω, 1 kΩ, 5 kΩ, 100 kΩ.

Miscellaneous

- Dummy loads for warm up, 1 each for Diode/Resistor inputs: 6-pin DIN (240°) connectors – plug, with 100 kΩ resistors configured for 4-lead measurement. Calibration cable with 100 kΩ standard can be used.
- Short length of uninsulated wire, 1 each for Thermocouple inputs.

8.9.2 Diode/Resistor Sensor Input Calibration

NOTE: The thermocouple input calibration procedure is provided in Paragraph 8.9.3.

Overview

Each sensor input requires calibration. Sensor Inputs contain a current source which can supply 10 µA or 1 mA of current, only the 10 µA current sources are calibrated. They are calibrated by adjusting pots on the Model 331 Main Board. The sensor inputs contain multiple gain stages to accommodate the various sensors the Model 331 supports. The input circuitry is not adjusted during calibration. Instead, precision voltages and resistors are attached to each input and mathematical calibration constants are calculated and programmed into the Model 331. Constants are stored to compensate for both input offset and gain errors.

Calibration Process**8.9.2.1 Sensor Input Calibration Setup and Serial Communication Verification**

Allow the Model 331 to warm up for at least 1 hour with 100 kΩ resistors attached to all inputs configured as diode/resistor and all thermocouple inputs shorted. Connect the Model 331 to the PC via the serial port. Verify serial communication by sending the *IDN? command and receiving the proper response from the Model 331. If the input not being calibrated is diode/resistor, leave a 100 kΩ resistor attached. If the other input is a thermocouple, leave a short across the input.

8.9.2.2 10 µA Current Source Calibration and 1 mA Current Source Verification**Purpose**

To calibrate the 10 µA current source to be within the specified tolerance and verify operation of the 1 mA current source.

Process

1. Configure the input for the Silicon Diode range.
2. Accurately determine the value of the 100 kΩ resistor using the DMM. Determine the calibration value by multiplying the actual resistance of the 100 kΩ resistor by 10 µA.
Example: $100.050 \text{ k}\Omega \times 10 \times 10^{-6} \text{ A} = 1.00050 \text{ V}$.
3. Attach the 100 kΩ resistor to the Model 331 input using proper 4-lead connection techniques, configure the DMM to read VDC and attach to the resistor.
4. Adjust the current source calibration pot, (R97 for Input A and R98 for Input B), on the Model 331 main board until the DMM reads exactly the value calculated in Step 2 to $\pm 0.00002 \text{ VDC}$.
5. 1 mA Current Source Verification. Configure the input for the 100Ω Plat/250 range.
6. Accurately determine the value of the 1 kΩ resistor using the DMM. Determine the verification value by multiplying the actual resistance of the 1 kΩ resistor by 1 mA.
7. Attach the 1 kΩ resistor to the Model 331 input using proper 4-lead connection techniques, configure the DMM to read VDC and attach to the resistor.
8. Verify the voltage across resistor to be within $\pm 0.3\%$ of the value calculated in Step 6.

8.9.2.3 Diode Input Ranges Calibration

Purpose

To determine the input offset and gain errors when the input is configured for the diode ranges and provide offset and gain calibration constants back to the Model 331.

Process

1. Configure the input for the diode range to be calibrated.
2. Reset the calibration constants to their default values using the **CALRSTZ** and **CALRSTG** commands.

EXAMPLE:
 Input: A
 Range: GaAIAs Diode
 Zero Offset Reset Command: **CALRSTZ A,1**
 Gain Reset Command: **CALRSTG A,1**

3. Short all four terminals, (I+, I-, V+, V-), of the input together, do not tie the terminals to ground.
4. Via the interface obtain the input reading using the **CALREAD?** command and record this number.
5. Program the offset calibration by negating the value read in the previous step and providing it using the **CALZ** command.

EXAMPLE:
 Input: A
 Range: GaAIAs Diode
CALREAD? Reading: +0.00005
 Calibration Command: **CALZ A,1,-0.00005**

6. Disconnect the V+ terminal from the others and connect to the positive output of the voltage reference. Connect the voltage reference negative output to the V-, I+, and I- terminals.
7. Set the voltage reference to provide the calibration voltage shown in Table 8-1. Using the DMM measure the voltage to the tolerance shown in Table 8-1.
8. Via the interface obtain the input reading using the **CALREAD?** command and record this number.
9. Program the gain calibration by dividing the measured value of the reference voltage by the value read in the previous step and provide the result using the **CALG** command. Note that the gain calibration constant will always be within 5% of 1.00000.

EXAMPLE:
 Input: A
 Range: GaAIAs Diode
 Measured Value of Reference Voltage: 7.50002 VDC
CALREAD? Reading: 7.49852
 Constant Calculation: 7.50002 / 7.49852 = 1.00020
 Calibration Command: **CALG A,1,1.00020**

10. Send the **CALSAVE** command to save the constants in the E² prom.
11. Perform calibration on both diode ranges.

Table 8-1. Calibration Table for Diode Ranges

Range	Voltage Reference Output	Reference Voltage Known To	Cal. Command Type Number
Silicon Diode	2.5 VDC	±0.00010 VDC	0
GaAIAs Diode	7.5 VDC	±0.00040 VDC	1

8.9.2.4 Resistive Input Ranges Calibration

Purpose

To determine the input offset and gain errors when the input is configured for the resistive ranges and provide offset and gain calibration constants back to the Model 331. This step will calibrate all resistive ranges with reversing both on and off.

Process

1. Configure the input for the resistive range to be calibrated.
2. Reset the calibration constants to their default values using the **CALRSTZ** and **CALRSTG** commands.

EXAMPLE:

Input: A
 Range: 100Ω Plat/250, Reversal Off
 Zero Offset Reset Command: **CALRSTZ A,2**
 Gain Reset Command: **CALRSTG A,2**

3. Short all four terminals, (I+, I-, V+, V-), of the input together, do not tie the terminals to ground.
4. Via the interface obtain the input reading using the **CALREAD?** command and record this number.
5. Program the offset calibration by negating the value read in the previous step and providing it using the **CALZ** command.

EXAMPLE:

Input: A
 Range: 100Ω Plat/250, Reversal Off
CALREAD? Reading: +000.003
 Calibration Command: **CALZ A,2,-0.003**

6. From Table 8-2 select the calibration resistor for the range being calibrated and use the DMM in 4-lead resistance measurement mode to measure the value of the resistor to the tolerance shown.
7. Attach the calibration resistor to the Model 331 sensor input. Be sure to connect the resistor using proper 4-lead connection techniques.
8. Via the interface obtain the input reading using the **CALREAD?** command and record this number.
9. Program the gain calibration by dividing the actual resistance of the calibration resistor by the value read in the previous step and provide the result using the **CALG** command. Note that the gain calibration constant will always be within 5% of 1.00000.

EXAMPLE:

Input: A
 Range: 100Ω Plat/250, Reversal Off
 Measured Value of Calibration Resistor: 100.0250Ω
CALREAD? Reading: 100.145
 Constant Calculation: 100.0250 / 100.145 = 0.99880
 Calibration Command: **CALG A,2,0.99880**

10. Send the **CALSAVE** command to save the constants in the E² prom.
11. Repeat the resistive input ranges calibration for all resistive ranges with reversal on and off.
12. Repeat all of Paragraph 8.9.2 for second input if Diode/Resistor.

Table 8-2. Calibration Table for Resistive Ranges

Range	Calibration Resistor Nominal Value	Resistor Value Known to	Reversal	Cal. Command Type Number
100 Ω Plat/250	100 Ω	±0.0070 Ω	Off	2
100 Ω Plat/250	100 Ω	±0.0070 Ω	On	10
100 Ω Plat/500	500 Ω	±0.0270 Ω	Off	3
100 Ω Plat/500	500 Ω	±0.0270 Ω	On	11
1000 Ω Plat	5 kΩ	±0.520 Ω	Off	4
1000 Ω Plat	5 kΩ	±0.520 Ω	On	12
NTC RTD	5 kΩ	±0.520 Ω	Off	5
NTC RTD	5 kΩ	±0.520 Ω	On	13

8.9.3 Diode Sensor Input Calibration – 1 mA Excitation Current

The instrument uses the calibration constants determined in the Diode Input Ranges Calibration (Paragraph 8.9.2.3), for the diode ranges that use 1 mA excitation. Therefore, no additional calibration is necessary.

NOTE: Standard diode curves and typical sensor performance (Table 1-2) are calculated using 10 µA excitation. Sensor temperature response characteristics will be altered if 1 mA excitation is selected.

8.9.4 Thermocouple Sensor Input Calibration

Overview

Each thermocouple sensor input requires calibration. The sensor inputs contain multiple gain stages to accommodate the various thermocouple sensors the Model 331 supports. The input circuitry is not adjusted during calibration. Instead, precision voltages are supplied to each input and mathematical calibration constants are calculated and programmed into the Model 331. Constants are stored to compensate for both input offset and gain errors. Thermocouple inputs do not use the current source.

Calibration Process

8.9.4.1 Sensor Input Calibration Setup

Allow the Model 331 to warm up for at least 1 hour with shorts placed across all thermocouple sensor inputs. If calibrating a dual thermocouple Model 331, leave a short across the input not currently being calibrated. If the other input is diode/resistor, place a 100 kΩ resistor on the input.

CAUTION: All thermocouple connections must be tight and direct with no unnecessary jumpers or connections.

8.9.4.2 Thermocouple Input Ranges Calibration

Purpose

To determine the input offset and gain errors when the input is configured for the thermocouple ranges and provide offset and gain calibration constants back to the Model 331.

Process

1. Configure the input for the thermocouple range to be calibrated. Turn Room Cal off.
2. Reset the calibration constants to their default values using the **CALRSTZ** and **CALRSTG** commands.

EXAMPLE:
 Input: A
 Range: Thermo/25mV
 Zero Offset Reset Command: **CALRSTZ A,6**
 Gain Reset Command: **CALRSTG A,6**

Thermocouple Input Ranges Calibration (Continued)

3. Short the V+ and V- terminals together, do not tie the terminals to ground.
4. Via the interface obtain the input reading using the **CALREAD?** command and record this number.
5. Program the offset calibration by negating the value read in the previous step and providing it using the **CALZ** command.

EXAMPLE:
 Input: A
 Range: Thermo/25mV
CALREAD? Reading: -00.0122
 Calibration Command: **CALZ A,6,+0.0122**

6. Connect input to standard and DMM with cable described in Paragraph 8.9.1.
7. Set the voltage reference to provide the calibration voltage shown in Table 8-3. Using the DMM measure the voltage to the tolerance shown in Table 8-3.
8. Via the interface obtain the input reading using the **CALREAD?** command and record this number.
9. Program the gain calibration by dividing the measured value of the reference voltage by the value read in the previous step and provide the result using the **CALG** command. Note that the gain calibration constant will always be within 5% of 1.00000.

EXAMPLE:
 Input: A
 Range: Thermo/25mV
 Measured Value of Reference Voltage: +25.0032 mV DC
CALREAD? Reading: +24.9867
 Constant Calculation: $+25.0032 / +24.9867 = 1.00066$
 Calibration Command: **CALG A,6,1.00066**

10. Send the **CALSAVE** command to save the constants in the E² prom.
11. Perform calibration on both thermocouple ranges.
12. Repeat for second input if thermocouple.

Table 8-3. Calibration Table for Thermocouple Ranges

Range	Voltage Reference Output	Reference Voltage Known to	Cal. Command Type Number
Thermo/25mV	+25 mV DC	±0.0070 mV DC	6
Thermo/50mV	+50 mV DC	±0.0130 mV DC	7

8.9.5 Analog Output Calibration (Model 331S Only)

Overview

The Model 331S has one analog output which requires calibration. Zero offset and gain errors are calibrated out by programming offset and gain constants to the instrument.

Calibration Process

8.9.5.1 Analog Output Calibration

Purpose

To determine the analog output offset and gain errors and provide offset and gain calibration constants back to the Model 331.

Process

1. Reset the calibration constants to their default values using the **CALRSTZ** and **CALRSTG** commands.

EXAMPLE:

Zero Offset Reset Command: **CALRSTZ V,1**
 Gain Reset Command: **CALRSTG V,1**

2. Connect the 100 kΩ resistor to the analog output. Connect the positive lead of the DMM to the analog output positive terminal, the negative lead is connected to the analog output negative terminal.
3. Set the analog output to manual mode, bipolar mode on, manual output of –100 %. Read the output voltage with the DMM to a tolerance of ±0.0010 VDC and record this negative full scale (–FS) value.
4. Determine the offset calibration constant by dividing the –FS value by 10, adding 1, and then negating the result.
5. Use the **CALZ** command to send the offset calibration constant.

EXAMPLE:

–FS DMM Reading: –10.0564
 Offset Constant Calculation: $-((-10.0564/10) + 1) = 0.00564$
 Calibration Command: **CALZ V,1,0.00564**

NOTE: Be careful to use the formula described above and not use the same process that calibrates the zero offset of the inputs.

6. Set the analog output to +100 %. Read the output voltage with the DMM to a tolerance of ±0.0010 VDC and record this positive full scale (+FS) value.
7. Determine the gain calibration constant by negating the –FS reading obtained in Step 3 and adding the +FS reading to the result and then dividing that number into 20.
8. Use the **CALG** command to send the gain calibration constant.

EXAMPLE:

+FS DMM Reading: 10.0432
 –FS DMM Reading: –10.0564
 Gain Constant Calculation: $20/(10.0432+10.0564) = 0.99504$
 Calibration Command: **CALG V,1,0.99504**

9. Send the **CALSAVE** command to save the constants in the E² prom.

8.9.5 Calibration Specific Interface Commands

CALG Gain Calibration Constant Command

Input: CALG <input>, <type>, <value>[term]

Format: a,nn,±nnnnnnn

<input> Specifies which input or analog output the gain calibration constant will be provided to. Valid entries are A or B for inputs and V for the analog output.

<type> Specifies the input sensor type. Valid entries are:

0 = Silicon Diode	6 = Thermo/25mV
1 = GaAIAs Diode or Analog Output	7 = Thermo/50mV
2 = 100Ω Plat/250 – Reversal Off	10 = 100Ω Plat/250 – Reversal On
3 = 100Ω Plat/500 – Reversal Off	11 = 100Ω Plat/500 – Reversal On
4 = 1000Ω Plat – Reversal Off	12 = 1000Ω Plat – Reversal On
5 = NTC RTD – Reversal Off	13 = NTC RTD – Reversal On

<value> Gain calibration constant value.

Remarks: Provides the gain calibration constant for the selected input or analog output.

CALG? Gain Calibration Constant Query

Input: CALG? <input>, <type>[term]

Format: a,nn

<input> A, B, or V

<type> 0–7 or 10–13

Returned: <value>[term]

Format: ±nnnnnnn (Refer to command for description)

CALREAD? Six Digit Input Reading Query

Input: CALREAD? <input>[term]

Format: a

<input> A or B

Returned: <value>[term]

Format: ±n.nnnnn

Remarks: Returns 6-digit value of selected input reading. Used for CALZ and CALG functions.

CALRSTG Reset Gain Calibration Constant Command

Input: CALRSTG <input>, <type>[term]

Format: a,nn

<input> Specifies which input for which to reset the gain calibration constant to the default value. Valid entries are A or B for inputs and V for the analog output.

<type> Specifies the input sensor type. Valid entries are:

0 = Silicon Diode	6 = Thermo/25mV
1 = GaAIAs Diode or Analog Output	7 = Thermo/50mV
2 = 100Ω Plat/250 – Reversal Off	10 = 100Ω Plat/250 – Reversal On
3 = 100Ω Plat/500 – Reversal Off	11 = 100Ω Plat/500 – Reversal On
4 = 1000Ω Plat – Reversal Off	12 = 1000Ω Plat – Reversal On
5 = NTC RTD – Reversal Off	13 = NTC RTD – Reversal On

Remarks: Resets the gain calibration constant for a specific input and type to its default value.

CALRSTZ Reset Zero Offset Calibration Constant Command
Input: CALRSTZ <input>, <type>[term]
Format: a,nn
 <input> Specifies which input for which to reset the zero offset calibration constant to the default value. Valid entries are A or B for inputs and V for the analog output.
 <type> Specifies the input sensor type. Valid entries are:
 0 = Silicon Diode 6 = Thermo/25mV
 1 = GaAlAs Diode or **Analog Output** 7 = Thermo/50mV
 2 = 100Ω Plat/250 – Reversal Off 10 = 100Ω Plat/250 – Reversal On
 3 = 100Ω Plat/500 – Reversal Off 11 = 100Ω Plat/500 – Reversal On
 4 = 1000Ω Plat – Reversal Off 12 = 1000Ω Plat – Reversal On
 5 = NTC RTD – Reversal Off 13 = NTC RTD – Reversal On
Remarks: Resets the zero offset calibration constant for a specific input and type to its default value.

CALSAVE Calibration Save Command
Input: CALSAVE [term]
Remarks: Saves all CALZ and CALG calibration constants to the E² prom.

CALZ Zero Offset Calibration Constant Command
Input: CALZ <input>, <type>, <value>[term]
Format: a,nn,±nnnnnnn
 <input> Specifies which input or analog output the zero offset calibration constant will be provided to. Valid entries are A or B for inputs and V for the analog output.
 <type> Specifies the input sensor type. Valid entries are:
 0 = Silicon Diode 6 = Thermo/25mV
 1 = GaAlAs Diode or **Analog Output** 7 = Thermo/50mV
 2 = 100Ω Plat/250 – Reversal Off 10 = 100Ω Plat/250 – Reversal On
 3 = 100Ω Plat/500 – Reversal Off 11 = 100Ω Plat/500 – Reversal On
 4 = 1000Ω Plat – Reversal Off 12 = 1000Ω Plat – Reversal On
 5 = NTC RTD – Reversal Off 13 = NTC RTD – Reversal On
 <value> Zero offset calibration constant value.
Remarks: Provides the zero offset calibration constant for the selected input or analog output.

CALZ? Zero Offset Calibration Constant Query
Input: CALZ? <input>, <type>[term]
Format: a,nn
 <input> A, B, or V
 <type> 0 – 7 or 10 – 13
Returned: <value>[term]
Format: ±nnnnnnn (Refer to command for description)

APPENDIX A

GLOSSARY OF TERMINOLOGY

absolute zero. The temperature of -273.16°C , or -459.69°F , or 0 K , thought to be the temperature at which molecular motion vanishes and a body would have no heat energy.¹

accuracy. The degree of correctness with which a measured value agrees with the true value.²

electronic accuracy. The accuracy of an instrument independent of the sensor.

sensor accuracy. The accuracy of a temperature sensor and its associated calibration or its ability to match a standard curve.

Alumel™. An aluminum-nickel alloy which comprises the negative lead of a Type K thermocouple.

American Standard Code for Information Exchange (ASCII). A standard code used in data transmission, in which 128 numerals, letters, symbols, and special control codes are represented by a 7-bit binary number as follows:

Bits		Col.													
b ₇	b ₆	b ₅	b ₄	b ₃	b ₂	b ₁	b ₀								
1	1	1	1	1	1	1	1								
Row	0	1	2	3	4	5	6	7							
0	0	0	0	0	0	0	0	NUL	DLE	SP	0	'	P	@	p
0	0	0	1	1	1	1	1	SOH	DC1	!	1	A	Q	a	q
0	0	1	0	2	2	2	2	STX	DC2	"	2	B	R	b	r
0	0	1	1	3	3	3	3	ETX	DC3	#	3	C	S	c	s
0	1	0	0	4	4	4	4	EOT	DC4	\$	4	D	T	d	t
0	1	0	1	5	5	5	5	ENG	NAK	%	5	E	U	e	u
0	1	1	0	6	6	6	6	ACK	SYN	&	6	F	V	f	v
0	1	1	1	7	7	7	7	BEL	ETB	'	7	G	W	g	w
1	0	0	0	8	8	8	8	BS	CAN	(8	H	X	h	x
1	0	0	1	9	9	9	9	HT	EM)	9	I	Y	i	y
1	0	1	0	10	10	10	10	LF	SS	*	:	J	Z	j	z
1	0	1	1	11	11	11	11	VT	ESC	+	;	K	[k	(
1	1	0	0	12	12	12	12	FF	FS	,	<	L	~	l	~
1	1	0	1	13	13	13	13	CR	GS	-	=	M]	m)
1	1	1	0	14	14	14	14	SO	RS	.	>	N	^	n	^
1	1	1	1	15	15	15	15	SI	US	/	?	O	_	o	DEL

American Wire Gage (AWG). Wiring sizes are defined as diameters in inches and millimeters as follows:

AWG	Dia. In.	Dia. mm	AWG	Dia. In.	Dia. mm	AWG	Dia. In.	Dia. mm	AWG	Dia. In.	Dia. mm
1	0.2893	7.348	11	0.0907	2.304	21	0.0285	0.7230	31	0.0089	0.2268
2	0.2576	6.544	12	0.0808	2.053	22	0.0253	0.6438	32	0.0080	0.2019
3	0.2294	5.827	13	0.0720	1.829	23	0.0226	0.5733	33	0.00708	0.178
4	0.2043	5.189	14	0.0641	1.628	24	0.0207	0.5106	34	0.00630	0.152
5	0.1819	4.621	15	0.0571	1.450	25	0.0179	0.4547	35	0.00561	0.138
6	0.1620	4.115	16	0.0508	1.291	26	0.0159	0.4049	36	0.00500	0.127
7	0.1443	3.665	17	0.0453	1.150	27	0.0142	0.3606	37	0.00445	0.1131
8	0.1285	3.264	18	0.0403	1.024	28	0.0126	0.3211	38	0.00397	0.1007
9	0.1144	2.906	19	0.0359	0.9116	29	0.0113	0.2859	39	0.00353	0.08969
10	0.1019	2.588	20	0.0338	0.8118	30	0.0100	0.2546	40	0.00314	0.07987

ambient temperature. The temperature of the surrounding medium, such as gas or liquid, which comes into contact with the apparatus.¹

ampere. The constant current that, if maintained in two straight parallel conductors of infinite length, of negligible circular cross section, and placed one meter apart in a vacuum, would produce between these conductors a force equal to 2×10^{-7} newton per meter of length.² This is one of the base units of the SI.

ampere-turn. A MKS unit of magnetomotive force equal to the magnetomotive force around a path linking one turn of a conducting loop carrying a current of one ampere; or 1.26 gilberts.

ampere/meter (A/m). The SI unit for magnetic field strength (H). 1 ampere/meter = $4\pi/1000$ oersted ≈ 0.01257 oersted.

analog controller. A feedback control system where there is an unbroken path of analog processing between the feedback device (sensor) and control actuator (heater).

analog data. Data represented in a continuous form, as contrasted with digital data having discrete values.¹

analog output. A voltage output from an instrument that is proportional to its input. For example, from a digital voltmeter, the output voltage is generated by a digital-to-analog converter so it has a discrete number of voltage levels.

anode. The terminal that is positive with respect to the other terminal when the diode is biased in the forward direction.²



asphyxiant gas. A gas which has little or no positive toxic effect but which can bring about unconsciousness and death by displacing air and thus depriving an organism of oxygen.

autotuning. In Lake Shore Temperature Controllers, the Autotuning algorithm automatically determines the proper settings for Gain (Proportional), Reset (Integral), and Rate (Derivative) by observing the time response of the system upon changes in setpoint.

B. Symbol for magnetic flux density. See Magnetic Flux Density.

bar. Unit of pressure equal to 10^5 pascal, or 0.98697 standard atmosphere.

Baud. A unit of signaling speed equal to the number of discrete conditions or signal events per second, or the reciprocal of the time of the shortest signal element in a character.²

bel (B). A dimensionless unit expressing the ration of two powers or intensities, or the ratio of a power to a reference power, such that the number of bels is the common logarithm of this ratio.¹

bifilar windings. A winding consisting of two insulated wires, side by side, with currents traveling through them in opposite directions.¹

bit. A contraction of the term "binary digit"; a unit of information represented by either a zero or a one.²

BNC. Bayonet Nut Connector.

boiling point. The temperature at which a substance in the liquid phase transforms to the gaseous phase; commonly refers to the boiling point at sea level and standard atmospheric pressure.

CalCurve™ Service. The service of storing a mathematical representation of a calibration curve on an EEPROM or installed in a Lake Shore instrument. Previously called Precision Option.

calibrate. To determine, by measurement or comparison with a standard, the correct value of each scale reading on a meter or other device, or the correct value for each setting of a control knob.¹

cathode. The terminal from which forward current flows to the external circuit.²



Carbon-Glass. A temperature sensing material fabricated from a carbon-impregnated glass matrix used to make the Lake Shore CGR family of sensors.

Celsius (°C) Scale. A temperature scale that registers the freezing point of water as 0 °C and the boiling point as 100 °C under normal atmospheric pressure. Celsius degrees are purely derived units, calculated from the Kelvin Thermodynamic Scale. Formerly known as "centigrade." See Temperature for conversions.

Cernox™. A Lake Shore resistance temperature detector based on a ceramic-oxy-nitride resistance material.

CGR. Carbon Glass Resistor.

cgs system of units. A system in which the basic units are the centimeter, gram, and second.²

Chebychev polynomials. A family of orthogonal polynomials which solve Chebychev's differential equation.¹

Chebychev differential equation. A special case of Gauss' hypergeometric second-order differential equation:
 $(1 - x^2) f''(x) - x f'(x) + n^2 f(x) = 0.$ ¹

Chromel™. A chromium-nickel alloy which comprises the positive lead of Type E and K thermocouples.

closed-loop. See feedback control system.

coercive force (coercive field). The magnetic field strength (H) required to reduce the magnetic induction (B) in a magnetic material to zero.

coercivity. generally used to designate the magnetic field strength (H) required to reduce the magnetic induction (B) in a magnetic material to zero from saturation. The coercivity would be the upper limit to the coercive force.

Constantan. A copper-nickel alloy which comprises the negative lead of Type E, J, and T thermocouples.

cryogen. See cryogenic fluid.¹

cryogenic. Refers to the field of low temperatures, usually -130 °F or below, as defined by 173.300(f) of Title 49 of the Code of Federal Regulations.

cryogenic fluid. A liquid that boils at temperatures of less than about 110 K at atmospheric pressure, such as hydrogen, helium, nitrogen, oxygen, air, or methane. Also known as cryogen.¹

cryostat. An apparatus used to provide low-temperature environments in which operations may be carried out under controlled conditions.¹

cryotronics. The branch of electronics that deals with the design, construction, and use of cryogenic devices.¹

Curie temperature (Tc). Temperature at which a magnetized sample is completely demagnetized due to thermal agitation. Named for Pierre Curie (1859 – 1906), a French chemist.

current source. A type of power supply that supplies a constant current through a variable load resistance by automatically varying its compliance voltage. A single specification given as "compliance voltage" means the output current is within specification when the compliance voltage is between zero and the specified voltage.

curve. A set of data that defines the temperature response of a temperature sensor. It is used to convert the signal from the sensor to temperature.

Curve 10. The voltage vs. temperature characteristic followed by all DT-400 Series Silicon Diode Temperature Sensors.

- decibels (dB).** A unit for describing the ratio of two powers or intensities, or the ratio of a power to a reference power; equal to one-tenth bel; if P_1 and P_2 are two amounts of power, the first is said to be n decibels greater, where $n = 10 \log_{10} (P_1/P_2)$.¹
- degree.** An incremental value in the temperature scale, i.e., there are 100 degrees between the ice point and the boiling point of water in the Celsius scale and 180 degrees between the same two points in the Fahrenheit scale.
- demagnetization.** when a sample is exposed to an applied field (H_a), poles are induced on the surface of the sample. Some of the returned flux from these poles is inside of the sample. This returned flux tends to decrease the net magnetic field strength internal to the sample yielding a true internal field (H_{int}) given by: $H_{int} = H_a - DM$, where M is the volume magnetization and D is the demagnetization factor. D is dependent on the sample geometry and orientation with respect to the field.
- deviation.** The difference between the actual value of a controlled variable and the desired value corresponding to the setpoint.¹
- Dewar flask.** A vessel having double walls, the space between being evacuated to prevent the transfer of heat and the surfaces facing the vacuum being heat-reflective; used to hold liquid gases and to study low-temperature phenomena.¹ Invented by Sir James Dewar (1842 – 1923), a Scottish physical chemist.
- differential permeability.** The slope of a B versus H curve: $\mu_d = dB/dH$.
- differential susceptibility.** The slope of a M versus H curve: $\chi_d = dM/dH$.
- digital controller.** A feedback control system where the feedback device (sensor) and control actuator (heater) are joined by a digital processor. In Lake Shore controllers the heater output is maintained as a variable DC current source.
- digital data.** Pertaining to data in the form of digits or interval quantities. Contrast with analog data.²
- dimensionless sensitivity.** Sensitivity of a physical quantity to a stimulus, expressed in dimensionless terms. The dimensionless temperature sensitivity of a resistance temperature sensor is expressed as $S_d = (T/R)(dR/dT)$ which is also equal to the slope of R versus T on a log-log plot, that is $S_d = d \ln R / d \ln T$. Note that the absolute temperature (in kelvin) must be used in these expressions.
- drift, instrument.** An undesired but relatively slow change in output over a period of time, with a fixed reference input.
Note: Drift is usually expressed in percent of the maximum rated value of the variable being measured.²
- dynamic data exchange (DDE).** A method of interprocess communication which passes data between processes and synchronized events. DDE uses shared memory to exchange data between applications and a protocol to synchronize the passing of data.
- dynamic link library (DLL).** A module that contains code, data, and Windows resources that multiple Windows programs can access.
- electromagnet.** A device in which a magnetic field is generated as the result of electrical current passing through a helical conducting coil. It can be configured as an iron-free solenoid in which the field is produced along the axis of the coil, or an iron-cored structure in which the field is produced in an air gap between pole faces. The coil can be water cooled copper or aluminum, or superconductive.
- electrostatic discharge (ESD).** A transfer of electrostatic charge between bodies at different electrostatic potentials caused by direct contact or induced by an electrostatic field.
- error.** Any discrepancy between a computed, observed, or measured quantity and the true, specified, or theoretically correct value or condition.²
- excitation.** Either an AC or DC input to a sensor used to produce an output signal. Common excitations include: constant current, constant voltage, or constant power.
- Fahrenheit (°F) Scale.** A temperature scale that registers the freezing point of water as 32 °F and the boiling point as 212 °F under normal atmospheric pressure. See Temperature for conversions.
- feedback control system.** A system in which the value of some output quantity is controlled by feeding back the value of the controlled quantity and using it to manipulate an input quantity so as to bring the value of the controlled quantity closer to a desired value. Also known as closed-loop control system.¹
- four-lead.** measurement technique where one pair of excitation leads and an independent pair of measurement leads are used to measure a sensor. This method reduces the effect of lead resistance on the measurement.
- GaAIAs.** Gallium-aluminum-arsenide semiconducting material used to make the special Lake Shore TG family of diode temperature sensors.
- gamma.** A cgs unit of low-level flux density, where 100,000 gamma equals one oersted, or 1 gamma equals 10^{-5} oersted.
- gauss (G).** The cgs unit for magnetic flux density (B). 1 gauss = 10^{-4} tesla. Named for Karl Fredrich Gauss (1777–1855) a German mathematician, astronomer, and physicist.
- gaussian system (units).** A system in which centimeter-gram-second units are used for electric and magnetic qualities.
- general purpose interface bus (GPIB).** Another term for the IEEE-488 bus.
- germanium (Ge).** A common temperature sensing material fabricated from doped germanium to make the Lake Shore GR family of resistance temperature sensor elements.

gilbert (Gb). A cgs electromagnetic unit of the magnetomotive force required to produce one maxwell of magnetic flux in a magnetic circuit of unit reluctance. One gilbert is equal to $10/4\pi$ ampere-turn. Named for William Gilbert (1540–1603), an English physicist; hypothesized that the earth is a magnet.

gilbert per centimeter. Practical cgs unit of magnet intensity. Gilberts per cm are the same as oersteds.

Greek alphabet. The Greek alphabet is defined as follows:

Alpha	α	A	Iota	ι	I	Rho	ρ	P
Beta	β	B	Kappa	κ	K	Sigma	σ	Σ
Gamma	γ	Γ	Lambda	λ	Λ	Tau	τ	T
Delta	δ	Δ	Mu	μ	M	Upsilon	υ	Y
Epsilon	ϵ	E	Nu	ν	N	Phi	ϕ	Φ
Zeta	ζ	Z	Xi	ξ	Ξ	Chi	χ	X
Eta	η	H	Omicron	o	O	Psi	ψ	Ψ
Theta	θ	Θ	Pi	π	Π	Omega	ω	Ω

ground. A conducting connection, whether intentional or accidental, by which an electric circuit or equipment is connected to the earth, or to some conducting body of relatively large extent that serves in place of the earth.

Note: It is used for establishing and maintaining the potential of the earth (or of the conducting body) or approximately that potential, on conductors connected to it, and for conducting ground current to and from the earth (or of the conducting body).²

H. Symbol for magnetic field strength. See Magnetic Field Strength.

Hall effect. The generation of an electric potential perpendicular to both an electric current flowing along a thin conducting material and an external magnetic field applied at right angles to the current. Named for Edwin H. Hall (1855–1938), an American physicist.

hazard communication standard (HCS). The OSHA standard cited in 29 CFR 1910.1200 requiring communication of risks from hazardous substances to workers in regulated facilities.

hertz (Hz). A unit of frequency equal to one cycle per second.

hysteresis. The dependence of the state of a system on its previous history, generally in the form of a lagging of a physical effect behind its cause.¹ Also see magnetic hysteresis.

I.D. Inner diameter.

IEC. International Electrotechnical Commission.

IEEE. Institute of Electrical and Electronics Engineers.

IEEE-488. An instrumentation bus with hardware and programming standards designed to simplify instrument interfacing. The addressable, parallel bus specification is defined by the IEEE.

initial permeability. The permeability determined at $H = 0$ and $B = 0$.

initial susceptibility. The susceptibility determined at $H = 0$ and $M = 0$.

infrared (IR). For practical purposes any radiant energy within the wavelength range 770 to 10^6 nanometers is considered infrared energy.² The full range is usually divided into three sub-ranges: near IR, far IR, and sub-millimeter.

input card. Electronics on a printed circuit board (card) that plug into an instrument main frame. Used by configurable instruments to allow for different sensor types or interface options.

interchangeability. Ability to exchange one sensor or device with another of the same type without a significant change in output or response.

international system of units (SI). A universal coherent system of units in which the following seven units are considered basic: meter, kilogram, second, ampere, kelvin, mole, and candela. The International System of Units, or *Système International d'Unités* (SI), was promulgated in 1960 by the Eleventh General Conference on Weights and Measures. For definition, spelling, and protocols, see Reference 3 for a short, convenient guide.

interpolation table. A table listing the output and sensitivity of a sensor at regular or defined points which may be different from the points at which calibration data was taken.

intrinsic coercivity. The magnetic field strength (H) required to reduce the magnetization (M) or intrinsic induction in a magnetic material to zero.

intrinsic induction. The contribution of the magnetic material (B_i) to the total magnetic induction (B).

$$B_i = B - \mu_0 H \quad (\text{SI}) \qquad B_i = B - H \quad (\text{cgs})$$

IPTS-68. International Practical Temperature Scale of 1968. Also abbreviated as T_{68} .

isolated (neutral system). A system that has no intentional connection to ground except through indicating, measuring, or protective devices of very-high impedance.²

ITS-90. International Temperature Scale of 1990. Also abbreviated as T_{90} . This scale was designed to bring into as close a coincidence with thermodynamic temperatures as the best estimates in 1989 allowed.

Kelvin (K). The unit of temperature on the Kelvin Scale. It is one of the base units of SI. The word “degree” and its symbol (°) are omitted from this unit. See Temperature Scale for conversions.

Kelvin Scale. The Kelvin Thermodynamic Temperature Scale is the basis for all international scales, including the ITS-90. It is fixed at two points: the absolute zero of temperature (0 K), and the triple point of water (273.16 K), the equilibrium temperature that pure water reaches in the presence of ice and its own vapor.

line regulation. The maximum steady-state amount that the output voltage or current changes as result of a specified change in input line voltage (usually for a step change between 105–125 or 210–250 volts, unless otherwise specified).

line voltage. The RMS voltage of the primary power source to an instrument.

liquid helium (LHe). Used for low temperature and superconductivity research: minimum purity 99.998%. Boiling point at 1 atm = 4.2 K. Latent heat of vaporization = 2.6 kilojoules per liter. Liquid density = 0.125 kilograms per liter.

EPA Hazard Categories: Immediate (Acute) Health and Sudden Release of Pressure Hazards
DOT Name: Helium, Refrigerated Liquid
DOT Label: Nonflammable Gas
DOT Class: Nonflammable Gas
DOT ID No.: UN 1963

liquid nitrogen (LN₂). Also used for low temperature and superconductivity research and for its refrigeration properties such as in freezing tissue cultures: minimum purity 99.998%, O₂ 8 ppm max. Boiling point at 1 atm = 77.4 K. Latent heat of vaporization = 160 kilojoules per liter. Liquid density = 0.81 kilograms per liter.

EPA Hazard Categories: Immediate (Acute) Health and Sudden Release of Pressure Hazards
DOT Name: Nitrogen, Refrigerated Liquid
DOT Label: Nonflammable Gas
DOT Class: Nonflammable Gas
DOT ID No.: UN 1977

load regulation. A steady-state decrease of the value of the specified variable resulting from a specified increase in load, generally from no-load to full-load unless otherwise specified.

M. Symbol for magnetization. See magnetization.

magnetic air gap. The air space, or non-magnetic portion, of a magnetic circuit.

magnetic field strength (H). The magnetizing force generated by currents and magnetic poles. For most applications, the magnetic field strength can be thought of as the applied field generated, for example, by a superconducting magnet. The magnetic field strength is not a property of materials. Measure in SI units of A/m or cgs units of oersted.

magnetic flux density (B). Also referred to as magnetic induction. This is the net magnetic response of a medium to an applied field, H. The relationship is given by the following equation: $B = \mu_0(H + M)$ for SI, and $B = H + 4\pi M$ for cgs, where H = magnetic field strength, M = magnetization, and $\mu_0 =$ permeability of free space = $4\pi \times 10^{-7}$ H/m.

magnetic hysteresis. The property of a magnetic material where the magnetic induction (B) for a given magnetic field strength (H) depends upon the past history of the samples magnetization.

magnetic induction (B). See magnetic flux density.

magnetic moment (m). This is the fundamental magnetic property measured with dc magnetic measurements systems such as a vibrating sample magnetometer, extraction magnetometer, SQUID magnetometer, etc. The exact technical definition relates to the torque exerted on a magnetized sample when placed in a magnetic field. Note that the moment is a total attribute of a sample and alone does not necessarily supply sufficient information in understanding material properties. A small highly magnetic sample can have exactly the same moment as a larger weakly magnetic sample (see Magnetization). Measured in SI units as $A \cdot m^2$ and in cgs units as emu. $1 \text{ emu} = 10^{-3} A \cdot m^2$.

magnetic units. Units used in measuring magnetic quantities. Includes ampere-turn, gauss, gilbert, line of force, maxwell, oersted, and unit magnetic pole.

magnetization (M). This is a material specific property defined as the magnetic moment (m) per unit volume (V). $M = m/V$. Measured in SI units as A/m and in cgs units as emu/cm^3 . $1 \text{ emu/cm}^3 = 10^3 \text{ A/m}$. Since the mass of a sample is generally much easier to determine than the volume, magnetization is often alternately expressed as a mass magnetization defined as the moment per unit mass.

material safety data sheet (MSDS). OSHA Form 20 contains descriptive information on hazardous chemicals under the OSHA Hazard Communication Standard (HCS). These data sheets also provide precautionary information on the safe handling of the gas as well as emergency and first aid procedures.

microcontroller. A microcomputer, microprocessor, or other equipment used for precise process control in data handling, communication, and manufacturing.¹

MKSA System of Units. A system in which the basic units are the meter, kilogram, and second, and the ampere is a derived unit defined by assigning the magnitude $4\pi \times 10^{-7}$ to the rationalized magnetic constant (sometimes called the permeability of space).

NBS. National Bureau of Standards. Now referred to as NIST.

negative temperature coefficient (NTC). Refers to the sign of the temperature sensitivity. For example, the resistance of a NTC sensor decreases with increasing temperature.

National Institute of Standards and Technology (NIST). Government agency located in Gaithersburg, Maryland and Boulder, Colorado, that defines measurement standards in the United States.

noise (electrical). Unwanted electrical signals that produce undesirable effects in circuits of control systems in which they occur.²

normalized sensitivity. For resistors, signal sensitivity (dR/dT) is geometry dependent; i.e., dR/dT scales directly with R ; consequently, very often this sensitivity is normalized by dividing by the measured resistance to give a sensitivity, s_T , in percent change per kelvin. $s_T = (100/R) (dR/dT) \%K$, where T is the temp. in kelvin and R is the resistance in ohms.

normally closed (N.C.). A term used for switches and relay contacts. Provides a closed circuit when actuator is in the free (unenergized) position.

normally open (N.O.). A term used for switches and relay contacts. Provides an open circuit when actuator is in the free (unenergized) position.

O.D. Outer diameter.

oersted (Oe). The cgs unit for the magnetic field strength (H). 1 oersted = $10^3/4\pi$ ampere/meter ≈ 79.58 ampere/meter.

ohm (Ω). The SI unit of resistance (and of impedance). The ohm is the resistance of a conductor such that a constant current of one ampere in it produces a voltage of one volt between its ends.²

open-loop. A control system in which the system outputs are controlled by system inputs only, and no account is taken of actual system output.¹

pascal (Pa). The SI unit of pressure equal to 1 N/m^2 . Equal to 1.45×10^{-4} psi, 1.0197×10^{-5} kg_f/cm², 7.5×10^{-3} torr, 4.191×10^{-3} inches of water, or 1×10^{-5} bar.

permeability. Material parameter which is the ratio of the magnetic induction (B) to the magnetic field strength (H): $\mu = B/H$. Also see Initial Permeability and Differential Permeability.

platinum (Pt). A common temperature sensing material fabricated from pure platinum to make the Lake Shore PT family of resistance temperature sensor elements.

polynomial fit. A mathematical equation used to fit calibration data. Polynomials are constructed of finite sums of terms of the form $a_i x_i$, where a_i is the i^{th} fit coefficient and x_i is some function of the dependent variable.

positive temperature coefficient (PTC). Refers to the sign of the temperature sensitivity. For example, the resistance of a PTC sensor increases with increasing temperature.

pounds per square inch (psi). A unit of pressure. 1 psi = 6.89473 kPa. Variations include psi absolute (psia) measured relative to vacuum (zero pressure) where one atmosphere pressure equals 14.696 psia and psi gauge (psig) where gauge measured relative to atmospheric or some other reference pressure.

ppm. Parts per million, e.g., 4×10^{-6} is four parts per million.

precision. Careful measurement under controlled conditions which can be repeated with similar results. See repeatability. Also means that small differences can be detected and measured with confidence. See resolution.

prefixes. SI prefixes used throughout this manual are as follows:

Factor	Prefix	Symbol	Factor	Prefix	Symbol
10^{24}	yotta	Y	10^{-1}	deci	d
10^{21}	zetta	Z	10^{-2}	centi	c
10^{18}	exa	E	10^{-3}	milli	m
10^{15}	peta	P	10^{-6}	micro	μ
10^{12}	tera	T	10^{-9}	nano	n
10^9	giga	G	10^{-12}	pico	p
10^6	mega	M	10^{-15}	femto	f
10^3	kilo	k	10^{-18}	atto	a
10^2	hecto	h	10^{-21}	zepto	z
10^1	deka	da	10^{-24}	yocto	y

probe. A long, thin body containing a sensing element which can be inserted into a system in order to make measurements. Typically, the measurement is localized to the region near the tip of the probe.

proportional, integral, derivative (PID). A control function where output is related to the error signal in three ways. Proportional (gain) acts on the instantaneous error as a multiplier. Integral (reset) acts on the area of error with respect to time and can eliminate control offset or droop. Derivative (rate) acts on the rate of change in error to dampen the system, reducing overshoot.

quench. A condition where the superconducting magnet goes "normal," i.e., becomes non-superconductive. When this happens, the magnet becomes resistive, heat is generated, liquid cryogen is boiled off, and the magnet power supply is shut down due to the sudden increase in current demand.

rack mount. An instrument is rack mountable when it has permanent or detachable brackets that allow it to be securely mounted in an instrument rack. The standard rack-mount is 19 inches wide. A full-rack instrument requires the entire width of the rack. Two half-rack instruments fit horizontally in one rack width.

relief valve. A type of pressure relief device which is designed to relieve excessive pressure, and to reclose and reseal to prevent further flow of gas from the cylinder after reseating pressure has been achieved.

remanence. The remaining magnetic induction in a magnetic material when the material is first saturated and then the applied field is reduced to zero. The remanence would be the upper limit to values for the remanent induction. Note that no strict convention exists for the use of remanent induction and remanence and in some contexts the two terms may be used interchangeably.

remament induction. The remaining magnetic induction in a magnetic material after an applied field is reduced to zero. Also see remanence.

repeatability. The closeness of agreement among repeated measurements of the same variable under the same conditions.²

resistance temperature detector (RTD). Resistive sensors whose electrical resistance is a known function of the temperature, made of, e.g., carbon-glass, germanium, platinum, or rhodium-iron.

resolution. The degree to which nearly equal values of a quantity can be discriminated.²

display resolution. The resolution of the physical display of an instrument. This is not always the same as the measurement resolution of the instrument. Decimal display resolution specified as "*n* digits" has 10^n possible display values. A resolution of *n* and one-half digits has 2×10^n possible values.

measurement resolution. The ability of an instrument to resolve a measured quantity. For digital instrumentation this is often defined by the analog to digital converter being used. A *n*-bit converter can resolve one part in 2^n . The smallest signal change that can be measured is the full scale input divided by 2^n for any given range. Resolution should not be confused with accuracy.

RhFe. Rhodium-iron. Rhodium alloyed with less than one atomic percent iron is used to make the Lake Shore RF family of sensors. Rhodium-iron is a spin fluctuation alloy which has a significant temperature coefficient of resistance below 20 K where most metals rapidly lose sensitivity.

Roman numerals. Letters employed in the ancient Roman system of numeration as follows:

I	1	VI	6	L	50
II	2	VII	7	C	100
III	3	VIII	8	D	500
IV	4	IX	9	M	1000
V	5	X	10		

root mean square (RMS). The square root of the time average of the square of a quantity; for a periodic quantity the average is taken over one complete cycle. Also known as effective value.¹

room-temperature compensation. Thermocouples are a differential measurement device. Their signal represents the difference in temperature between their ends. An ice bath is often used to reference the measurement end to 0 degrees Celsius so most curves are normalized to that temperature. Room-temperature compensation replaces an ice bath by monitoring the temperature of the thermocouple terminals and normalizing the reading mathematically.

RS-232C. Bi-directional computer serial interface standard defined by the Electronic Industries Association (EIA). The interface is single-ended and non-addressable.

Seebeck effect. The development of a voltage due to differences in temperature between two junctions of dissimilar metals in the same circuit.¹

self-heating. Heating of a device due to dissipation of power resulting from the excitation applied to the device. The output signal from a sensor increases with excitation level, but so does the self-heating and the associated temperature measurement error.

sensitivity. The ratio of the response or change induced in the output to a stimulus or change in the input. Temperature sensitivity of a resistance temperature detector is expressed as $S = dR/dT$.

setpoint. The value selected to be maintained by an automatic controller.¹

serial interface. A computer interface where information is transferred one bit at a time rather than one byte (character) at a time as in a parallel interface. RS-232C is the most common serial interface.

SI. Système International d'Unités. See International System of Units.

silicon diode. Temperature sensor based on the forward voltage drop at constant current through a pn semiconductor junction formed in crystalline silicon.

SoftCal™. In Lake Shore instruments, SoftCal™ is used to improve the accuracy of a DT-400 Series Silicon Temperature Diode Sensor. This reduces the error between the sensor and the Standard Curve 10 used by the instrument to convert input voltage from the diode to a corresponding temperature.

stability. The ability of an instrument or sensor to maintain a constant output given a constant input.

strain relief. A predetermined amount of slack to relieve tension in component or lead wires. Also called stress relief.

superconducting magnet. An electromagnet whose coils are made of a type II superconductor with a high transition temperature and extremely high critical field, such as niobium-tin, Nb₃Sn; it is capable of generating magnetic fields of 100,000 oersteds and more with no steady power dissipation.¹ See electromagnet.

susceptance. In electrical terms, susceptance is defined as the reciprocal of reactance and the imaginary part of the complex representation of admittance: [suscept(ibility) + (conduct)ance].

susceptibility (χ). Parameter giving an indication of the response of a material to an applied magnetic field. The susceptibility is the ratio of the magnetization (M) to the applied field (H). $\chi = M/H$. In both SI units and cgs units the volume susceptibility is a dimensionless parameter. Multiply the cgs susceptibility by 4π to yield the SI susceptibility. See also Initial Susceptibility and Differential Susceptibility. As in the case of magnetization, the susceptibility is often seen expressed as a mass susceptibility or a molar susceptibility depending upon how M is expressed.

temperature scales. See Kelvin Scale, Celsius Scale, and ITS-90. Proper metric usage requires that only kelvin and degrees Celsius be used. However, since degrees Fahrenheit is in such common use, all three scales are delineated as follows:

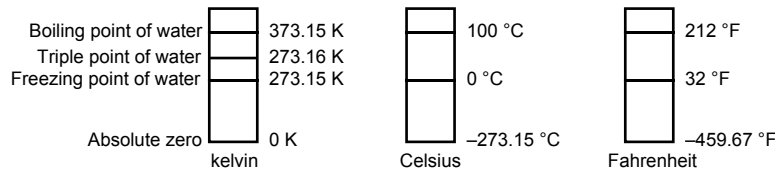

To convert kelvin to Celsius, subtract 273.15.

To convert Celsius to Fahrenheit: multiply °C by 1.8 then add 32, or: $^{\circ}\text{F} = (1.8 \times ^{\circ}\text{C}) + 32$.

To convert Fahrenheit to Celsius: subtract 32 from °F then divide by 1.8, or: $^{\circ}\text{C} = (^{\circ}\text{F} - 32) / 1.8$.

temperature coefficient, measurement. The measurement accuracy of an instrument is affected by changes in ambient temperature. The error is specified as an amount of change (usually in percent) for every one degree change in ambient temperature.

tesla (T). The SI unit for magnetic flux density (B). 1 tesla = 10^4 gauss

thermal emf. An electromotive force arising from a difference in temperature at two points along a circuit, as in the Seebeck effect.¹

thermocouple. A pair of dissimilar conductors so joined at two points that an electromotive force is developed by the thermoelectric effects when the junctions are at different temperatures.²

tolerance. The range between allowable maximum and minimum values.

torr. Unit of pressure. 1 torr \approx 1 mm of mercury. 1 atmosphere = 760 torr.

two-lead. Measurement technique where one pair of leads is used for both excitation and measurement of a sensor. This method will not reduce the effect of lead resistance on the measurement.

Underwriters Laboratories (UL). An independent laboratory that establishes standards for commercial and industrial products.

unit magnetic pole. A pole with a strength such that when it is placed 1 cm away from a like pole, the force between the two is 1 dyne.

volt (V). The difference of electric potential between two points of a conductor carrying a constant current of one ampere, when the power dissipated between these points is equal to one watt.²

volt-ampere (VA). The SI unit of apparent power. The volt-ampere is the apparent power at the points of entry of a single-phase, two-wire system when the product of the RMS value in amperes of the current by the RMS value in volts of the voltage is equal to one.²

VSM. Vibrating Sample Magnetometer.

watt (W). The SI unit of power. The watt is the power required to do work at the rate of 1 joule per second.²

References:

- 1 Sybil P. Parker, Editor. *McGraw-Hill Dictionary of Scientific and Technical Terms: Fifth Edition.* New York: McGraw Hill, 1994 (ISBN 0-07-113584-7)
- 2 Christopher J. Booth, Editor. *The New IEEE Standard Dictionary of Electrical and Electronic Terms: IEEE Std 100-1992, Fifth Edition.* New York: Institute of Electrical and Electronics Engineers, 1993 (ISBN 1-55937-240-0)
- 3 Nelson, Robert A. *Guide For Metric Practice*, Page BG7 - 8, Physics Today, Eleventh Annual Buyer's Guide, August 1994 (ISSN 0031-9228 coden PHTOAD)

APPENDIX B

TEMPERATURE SCALES

B1.0 DEFINITION

Temperature is a fundamental unit of measurement which describes the kinetic and potential energies of the atoms and molecules of bodies. When the energies and velocities of the molecules in a body are increased, the temperature is increased whether the body is a solid, liquid, or gas. Thermometers are used to measure temperature. The temperature scale is based on the temperature at which ice, liquid water, and water vapor are all in equilibrium. This temperature is called the triple point of water and is assigned the value 0 °C, 32 °F, and 273.15 K. These three temperature scales are defined as follows:

Celsius. Abbreviation: °C. A temperature scale that registers the freezing point of water as 0 °C and the boiling point as 100 °C under normal atmospheric pressure. Formerly known as “Centigrade.” Originally devised by Anders Celsius (1701–1744), a Swedish astronomer.

Fahrenheit. Abbreviation: °F. A temperature scale that registers the freezing point of water as 32 °F and the boiling point as 212 °F under normal atmospheric pressure. Originally devised by Gabriel Fahrenheit (1686–1736), a German physicist residing in Holland; developed use of mercury in thermometry.

Kelvin. Abbreviation: K. An absolute scale of temperature, the zero point of which is approximately –273.15°C. Scale units are equal in magnitude to Celsius degrees. Originally devised by Lord Kelvin, William Thompson, (1824–1907), a British physicist, mathematician, and inventor.

B2.0 COMPARISON

The three temperature scales are graphically compared in Figure B-1.

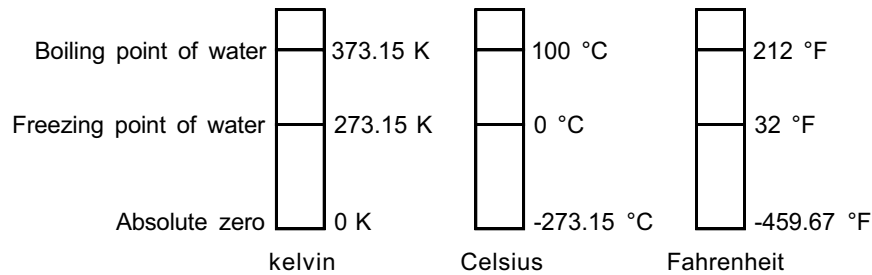

Figure B-1. Temperature Scale Comparison

B3.0 CONVERSIONS

To convert Fahrenheit to Celsius: subtract 32 from °F then divide by 1.8, or:

$$^{\circ}\text{C} = (^{\circ}\text{F} - 32) \div 1.8$$

To convert Celsius to Fahrenheit: multiply °C by 1.8 then add 32, or:

$$^{\circ}\text{F} = (1.8 \times ^{\circ}\text{C}) + 32$$

To convert Fahrenheit to kelvin, first convert °F to °C, then add 273.15.

To convert Celsius to kelvin, add 273.15.

Table B-1. Temperature Conversion Table

°F	°C	K	°F	°C	K	°F	°C	K
-459.67	-273.15	0	-292	-180	93.15	-129.67	-89.82	183.33
-454	-270	3.15	-290	-178.89	94.26	-120	-84.44	188.71
-450	-267.78	5.37	-289.67	-178.71	94.44	-119.67	-84.26	188.89
-449.67	-267.59	5.56	-280	-173.33	99.82	-117.67	-83.15	190
-441.67	-263.15	10	-279.67	-173.15	100	-112	-80	193.15
-440	-262.22	10.93	-274	-170	103.15	-110	-78.89	194.26
-439.67	-262.04	11.11	-270	-167.78	105.57	-109.67	-78.71	194.44
-436	-260	13.15	-269.67	-167.59	105.56	-100	-73.33	199.82
-430	-256.67	16.48	-261.67	-163.15	110	-99.67	-73.15	200
-429.67	-256.48	16.67	-260	-162.22	110.93	-94	-70	203.15
-423.67	-253.15	20	-259.67	-162.04	111.11	-90	-67.78	205.37
-420	-251.11	22.04	-256	-160	113.15	-89.67	-67.59	205.56
-419.67	-250.93	22.22	-250	-156.67	116.48	-81.67	-63.15	210
-418.00	-250	23.15	-249.67	-156.48	116.67	-80	-62.22	210.93
-410	-245.56	27.59	-243.67	-153.15	120	-79.67	-62.04	211.11
-409.67	-245.37	27.78	-240	-151.11	122.04	-76	-60	213.15
-405.67	-243.15	30	-239.67	-150.93	122.22	-70	-56.67	216.48
-400	-240	33.15	-238	-150	123.15	-69.67	-56.48	216.67
-399.67	-239.82	33.33	-230	-145.56	127.59	-63.67	-53.15	220
-390	-234.44	38.71	-229.67	-145.37	127.78	-60	-51.11	222.04
-389.67	-234.26	38.89	-225.67	-143.15	130	-59.67	-50.93	222.22
-387.67	-233.15	40	-220	-140	133.15	-58	-50	223.15
-382	-230	43.15	-219.67	-139.82	133.33	-50	-45.56	227.59
-380	-228.89	44.26	-210	-134.44	138.71	-49.67	-45.37	227.78
-379.67	-228.71	44.44	-209.67	-134.26	138.89	-45.67	-43.15	230
-370	-223.33	49.82	-207.67	-133.15	140	-40	-40	233.15
369.67	-223.15	50	-202	-130	143.15	-39.67	-39.82	233.33
-364	-220	53.15	-200	-128.89	144.26	-30	-34.44	238.71
-360	-217.78	55.37	-199.67	-128.71	144.44	-29.67	-34.26	238.89
-359.67	-217.59	55.56	-190	-123.33	149.82	-27.67	-33.15	240
-351.67	-213.15	60	189.67	-123.15	150	-22	-30	243.15
-350	-212.22	60.93	-184	-120	153.15	-20	-28.89	244.26
-349.67	-212.04	61.11	-180	-117.78	155.37	-19.67	-28.71	244.44
-346	-210	63.15	-179.67	-117.59	155.56	-10	-23.33	249.82
-340	-206.67	66.48	-171.67	-113.15	160	-9.67	-23.15	250
-339.67	-206.48	66.67	-170	-112.22	160.93	-4	-20	253.15
-333.67	-203.15	70	-169.67	-112.04	161.11	0	-17.78	255.37
-330	-201.11	72.04	-166	-110	163.15	+0.33	-17.59	255.56
-329.67	-200.93	72.22	-160	-106.67	166.48	8.33	-13.15	260
-328	-200	73.15	-159.67	-106.48	166.67	10	-12.22	260.93
-320	-195.56	77.59	-153.67	103.15	170	10.33	-12.04	261.11
-319.67	-195.37	77.78	-150	-101.11	172.04	14	-10	263.15
-315.67	-193.15	80	-149.67	-100.93	172.22	20	-6.67	266.48
-310	-190	83.15	-148	-100	173.15	20.33	-6.48	266.67
-309.67	-189.82	83.33	-140	-95.96	177.59	26.33	-3.15	270
-300	-184.44	88.71	-139.67	-95.37	177.78	30	-1.11	272.04
-299.67	-184.26	88.89	-135.67	-93.15	180	30.33	-0.93	272.22
-297.67	-183.15	90	-130	-90	183.15	32	0	273.15

APPENDIX C

HANDLING LIQUID HELIUM AND NITROGEN

C1.0 GENERAL

Use of liquid helium (LHe) and liquid nitrogen (LN₂) is often associated with the Model 331 Temperature Controller. Although not explosive, there are a number of safety considerations to keep in mind in the handling of LHe and LN₂.

C2.0 PROPERTIES

LHe and LN₂ are colorless, odorless, and tasteless gases. Gaseous nitrogen makes up about 78 percent of the Earth's atmosphere, while helium comprises only about 5 ppm. Most helium is recovered from natural gas deposits. Once collected and isolated, the gases will liquefy when properly cooled. A quick comparison between LHe and LN₂ is provided in Table C-1.

Table C-1. Comparison of Liquid Helium and Liquid Nitrogen

PROPERTY	LIQUID HELIUM	LIQUID NITROGEN
Boiling Point @1 atm, in K	4.2	77
Thermal Conductivity (Gas), w/cm-K	0.083	0.013
Latent Heat of Vaporization, Btu/liter	2.4	152
Liquid Density, pounds/liter	0.275	0.78

C3.0 HANDLING CRYOGENIC STORAGE DEWARs

Cryogenic containers (dewars) must be operated in accordance with the manufacturer instructions. Safety instructions will also be posted on the side of each dewar. Cryogenic dewars must be kept in a well-ventilated place where they are protected from the weather and away from any sources of heat. A typical cryogenic dewar is shown in Figure C-1.

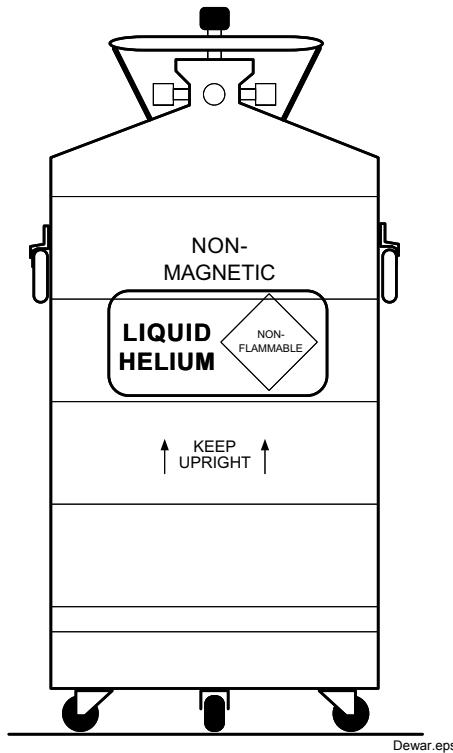

Figure C-1. Typical Cryogenic Storage Dewar

C4.0 LIQUID HELIUM AND NITROGEN SAFETY PRECAUTIONS

Transferring LHe and LN₂ and operation of the storage dewar controls should be in accordance with the manufacturer/supplier's instructions. During this transfer, it is important that all safety precautions written on the storage dewar and recommended by the manufacturer be followed.

WARNING: Liquid helium and liquid nitrogen are potential asphyxiants and can cause rapid suffocation without warning. Store and use in area with adequate ventilation. DO NOT vent container in confined spaces. DO NOT enter confined spaces where gas may be present unless area has been well ventilated. If inhaled, remove to fresh air. If not breathing, give artificial respiration. If breathing is difficult, give oxygen. Get medical help.

WARNING: Liquid helium and liquid nitrogen can cause severe frostbite to the eyes or skin. DO NOT touch frosted pipes or valves. In case of frostbite, consult a physician at once. If a physician is not readily available, warm the affected areas with water that is near body temperature.

The two most important safety aspects to consider when handling LHe and LN₂ are adequate ventilation and eye and skin protection. Although helium and nitrogen gases are non-toxic, they are dangerous in that they replace the air in a normal breathing atmosphere. Liquid products are of an even greater threat since a small amount of liquid evaporates to create a large amount of gas. Therefore, it is imperative that cryogenic dewars be stored and the MTD System be operated in open and well ventilated areas.

Persons transferring LHe and LN₂ should make every effort to protect eyes and skin from accidental contact with liquid or the cold gas issuing from it. Protect your eyes with full face shield or chemical splash goggles. Safety glasses (even with side shields) are not adequate. Always wear special cryogenic gloves (Tempshield Cryo-Gloves® or equivalent) when handling anything that is, or may have been, in contact with the liquid or cold gas, or with cold pipes or equipment. Long sleeve shirts and cuffless trousers that are of sufficient length to prevent liquid from entering the shoes are recommended.

C5.0 RECOMMENDED FIRST AID

Every site that stores and uses LHe and LN₂ should have an appropriate Material Safety Data Sheet (MSDS) present. The MSDS may be obtained from the manufacturer/distributor. The MSDS will specify the symptoms of overexposure and the first aid to be used. A typical summary of these instructions is provided as follows.

If symptoms of asphyxia such as headache, drowsiness, dizziness, excitation, excess salivation, vomiting, or unconsciousness are observed, remove the victim to fresh air. If breathing is difficult, give oxygen. If breathing has stopped, give artificial respiration. Call a physician immediately.

If exposure to cryogenic liquids or cold gases occurs, restore tissue to normal body temperature (98.6°F) as rapidly as possible, then protect the injured tissue from further damage and infection. Call a physician immediately. Rapid warming of the affected parts is best achieved by bathing it in warm water. The water temperature should not exceed 105 °F (40 °C), and under no circumstances should the frozen part be rubbed, either before or after rewarming. If the eyes are involved, flush them thoroughly with warm water for at least 15 minutes. In case of massive exposure, remove clothing while showering with warm water. The patient should not drink alcohol or smoke. Keep warm and rest. Call a physician immediately.

APPENDIX D

CURVE TABLES

D1.0 GENERAL

Standard curve tables included in the Model 331 Temperature Controller are as follows:

Curve 01	DT-470 Silicon Diode	Table D-1
Curve 02	DT-670 Silicon Diode	Table D-2
Curve 03 & 04	DT-500-D/-E1 Silicon Diode.....	Table D-3
Curve 06 & 07	PT-100/-1000 Platinum RTD.....	Table D-4
Curve 08	RX-102A Rox™	Table D-5
Curve 09	RX-202A Rox™	Table D-6
Curve 12	Type K Thermocouple.....	Table D-7
Curve 13	Type E Thermocouple.....	Table D-8
Curve 14	Type T Thermocouple	Table D-9
Curve 15	Chromel-AuFe 0.03% Thermocouple	Table D-10
Curve 16	Chromel-AuFe 0.07% Thermocouple	Table D-11

Table D-1. Lake Shore DT-470 Silicon Diode (Curve 10)

Break-point	Temp. (K)	Volts	Break-point	Temp. (K)	Volts	Break-point	Temp. (K)	Volts
1	475.0	0.09062	30	170.0	0.82405	59	031.0	1.10476
2	470.0	0.10191	31	160.0	0.84651	60	030.0	1.10702
3	465.0	0.11356	32	150.0	0.86874	61	029.0	1.10945
4	460.0	0.12547	33	145.0	0.87976	62	028.0	1.11212
5	455.0	0.13759	34	140.0	0.89072	63	027.0	1.11517
6	450.0	0.14985	35	135.0	0.90161	64	026.0	1.11896
7	445.0	0.16221	36	130.0	0.91243	65	025.0	1.12463
8	440.0	0.17464	37	125.0	0.92317	66	024.0	1.13598
9	435.0	0.18710	38	120.0	0.93383	67	023.0	1.15558
10	430.0	0.19961	39	115.0	0.94440	68	022.0	1.17705
11	420.0	0.22463	40	110.0	0.95487	69	021.0	1.19645
12	410.0	0.24964	41	105.0	0.96524	70	019.5	1.22321
13	400.0	0.27456	42	100.0	0.97550	71	017.0	1.26685
14	395.0	0.28701	43	095.0	0.98564	72	015.0	1.30404
15	380.0	0.32417	44	090.0	0.99565	73	013.5	1.33438
16	365.0	0.36111	45	085.0	1.00552	74	012.5	1.35642
17	345.0	0.41005	46	080.0	1.01525	75	011.5	1.38012
18	330.0	0.44647	47	075.0	1.02482	76	010.5	1.40605
19	325.0	0.45860	48	070.0	1.03425	77	009.5	1.43474
20	305.0	0.50691	49	065.0	1.04353	78	008.5	1.46684
21	300.0	0.51892	50	058.0	1.05630	79	007.5	1.50258
22	285.0	0.55494	51	052.0	1.06702	80	005.2	1.59075
23	265.0	0.60275	52	046.0	1.07750	81	004.2	1.62622
24	250.0	0.63842	53	040.0	1.08781	82	003.4	1.65156
25	235.0	0.67389	54	039.0	1.08953	83	002.6	1.67398
26	220.0	0.70909	55	036.0	1.09489	84	002.1	1.68585
27	205.0	0.74400	56	034.0	1.09864	85	001.7	1.69367
28	190.0	0.77857	57	033.0	1.10060	86	001.4	1.69818
29	180.0	0.80139	58	032.0	1.10263			

Table D-2. Standard DT-670 Diode Curve

Breakpoint	V	Temp. (K)	Breakpoint	V	Temp. (K)	Breakpoint	V	Temp. (K)
1	0.090570	500.0	26	1.01064	87.0	51	1.19475	20.2
2	0.110239	491.0	27	1.02125	81.0	52	1.24208	17.10
3	0.136555	479.5	28	1.03167	75.0	53	1.26122	15.90
4	0.179181	461.5	29	1.04189	69.0	54	1.27811	14.90
5	0.265393	425.5	30	1.05192	63.0	55	1.29430	14.00
6	0.349522	390.0	31	1.06277	56.4	56	1.31070	13.15
7	0.452797	346.0	32	1.07472	49.0	57	1.32727	12.35
8	0.513393	320.0	33	1.09110	38.7	58	1.34506	11.55
9	0.563128	298.5	34	1.09602	35.7	59	1.36423	10.75
10	0.607845	279.0	35	1.10014	33.3	60	1.38361	10.00
11	0.648723	261.0	36	1.10393	31.2	61	1.40454	9.25
12	0.686936	244.0	37	1.10702	29.6	62	1.42732	8.50
13	0.722511	228.0	38	1.10974	28.3	63	1.45206	7.75
14	0.755487	213.0	39	1.11204	27.3	64	1.48578	6.80
15	0.786992	198.5	40	1.11414	26.5	65	1.53523	5.46
16	0.817025	184.5	41	1.11628	25.8	66	1.56684	4.56
17	0.844538	171.5	42	1.11853	25.2	67	1.58358	4.04
18	0.869583	159.5	43	1.12090	24.7	68	1.59690	3.58
19	0.893230	148.0	44	1.12340	24.3	69	1.60756	3.18
20	0.914469	137.5	45	1.12589	24.0	70	1.62125	2.62
21	0.934356	127.5	46	1.12913	23.7	71	1.62945	2.26
22	0.952903	118.0	47	1.13494	23.3	72	1.63516	1.98
23	0.970134	109.0	48	1.14495	22.8	73	1.63943	1.74
24	0.986073	100.5	49	1.16297	22.0	74	1.64261	1.53
25	0.998925	93.5	50	1.17651	21.3	75	1.64430	1.40

Table D-3. Lake Shore DT-500 Series Silicon Diode Curves (No longer in production)

Breakpoint	DT-500-D Curve		DT-500-E1 Curve	
	Temp. (K)	Volts	Temp. (K)	Volts
1	365.0	0.19083	330.0	0.28930
2	345.0	0.24739	305.0	0.36220
3	305.0	0.36397	285.0	0.41860
4	285.0	0.42019	265.0	0.47220
5	265.0	0.47403	240.0	0.53770
6	240.0	0.53960	220.0	0.59260
7	220.0	0.59455	170.0	0.73440
8	170.0	0.73582	130.0	0.84490
9	130.0	0.84606	100.0	0.92570
10	090.0	0.95327	075.0	0.99110
11	070.0	1.00460	060.0	1.02840
12	055.0	1.04070	040.0	1.07460
13	040.0	1.07460	036.0	1.08480
14	034.0	1.09020	034.0	1.09090
15	032.0	1.09700	032.0	1.09810
16	030.0	1.10580	030.0	1.10800
17	029.0	1.11160	029.0	1.11500
18	028.0	1.11900	028.0	1.12390
19	027.0	1.13080	027.0	1.13650
20	026.0	1.14860	026.0	1.15590
21	025.0	1.17200	025.0	1.18770
22	023.0	1.25070	024.0	1.23570
23	021.0	1.35050	022.0	1.33170
24	017.0	1.63590	018.0	1.65270
25	015.0	1.76100	013.0	1.96320
26	013.0	1.90660	009.0	2.17840
27	009.0	2.11720	004.0	2.53640
28	003.0	2.53660	003.0	2.59940
29	001.4	2.59840	001.4	2.65910

Table D-4. Lake Shore PT-100/1000 Platinum RTD Curves

Break-point	PT-100		PT-1000	
	Temp. (K)	Ohms (Ω)	Temp. (K)	Ohms (Ω)
1	030.0	3.820	030.0	38.20
2	032.0	4.235	032.0	42.35
3	036.0	5.146	036.0	51.46
4	038.0	5.650	038.0	56.50
5	040.0	6.170	040.0	61.70
6	042.0	6.726	042.0	67.26
7	046.0	7.909	046.0	79.09
8	052.0	9.924	052.0	99.24
9	058.0	12.180	058.0	121.80
10	065.0	15.015	065.0	150.15
11	075.0	19.223	075.0	192.23
12	085.0	23.525	085.0	235.25
13	105.0	32.081	105.0	320.81
14	140.0	46.648	140.0	466.48
15	180.0	62.980	180.0	629.80
16	210.0	75.044	210.0	750.44
17	270.0	98.784	270.0	987.84
18	315.0	116.270	315.0	1162.70
19	355.0	131.616	355.0	1316.16
20	400.0	148.652	400.0	1486.52
21	445.0	165.466	445.0	1654.66
22	490.0	182.035	490.0	1820.35
23	535.0	198.386	535.0	1983.86
24	585.0	216.256	585.0	2162.56
25	630.0	232.106	630.0	2321.06
26	675.0	247.712	675.0	2477.12
27	715.0	261.391	715.0	2613.91
28	760.0	276.566	760.0	2765.66
29	800.0	289.830	800.0	2898.30

Table D-5. Lake Shore RX-102A Rox™ Curve

Break-point	logΩ	Temp. (K)	Break-point	logΩ	Temp. (K)	Break-point	logΩ	Temp. (K)
1	3.02081	40.0	36	3.05186	13.50	71	3.17838	2.96
2	3.02133	38.8	37	3.05322	13.10	72	3.18540	2.81
3	3.02184	37.7	38	3.05466	12.70	73	3.19253	2.67
4	3.02237	36.6	39	3.05618	12.30	74	3.20027	2.53
5	3.02294	35.5	40	3.05780	11.90	75	3.20875	2.39
6	3.02353	34.4	41	3.05952	11.50	76	3.21736	2.26
7	3.02411	33.4	42	3.06135	11.10	77	3.22675	2.13
8	3.02472	32.4	43	3.06330	10.70	78	3.23707	2.00
9	3.02537	31.4	44	3.06537	10.30	79	3.24842	1.87
10	3.02605	30.4	45	3.06760	9.90	80	3.26000	1.75
11	3.02679	29.4	46	3.06968	9.55	81	3.27169	1.64
12	3.02749	28.5	47	3.07190	9.20	82	3.28462	1.53
13	3.02823	27.6	48	3.07428	8.85	83	3.29779	1.43
14	3.02903	26.7	49	3.07685	8.50	84	3.31256	1.33
15	3.02988	25.8	50	3.07922	8.20	85	3.32938	1.23
16	3.03078	24.9	51	3.08175	7.90	86	3.34846	1.130
17	3.03176	24.0	52	3.08447	7.60	87	3.37196	1.020
18	3.03280	23.1	53	3.08786	7.25	88	3.39220	0.935
19	3.03393	22.2	54	3.09150	6.90	89	3.41621	0.850
20	3.03500	21.4	55	3.09485	6.60	90	3.44351	0.765
21	3.03615	20.6	56	3.09791	6.35	91	3.47148	0.690
22	3.03716	19.95	57	3.10191	6.05	92	3.50420	0.615
23	3.03797	19.45	58	3.10638	5.74	93	3.54057	0.545
24	3.03882	18.95	59	3.11078	5.46	94	3.58493	0.474
25	3.03971	18.45	60	3.11558	5.18	95	3.63222	0.412
26	3.04065	17.95	61	3.12085	4.90	96	3.68615	0.354
27	3.04164	17.45	62	3.12622	4.64	97	3.75456	0.295
28	3.04258	17.00	63	3.13211	4.38	98	3.82865	0.245
29	3.04357	16.55	64	3.13861	4.12	99	3.91348	0.201
30	3.04460	16.10	65	3.14411	3.92	100	4.01514	0.162
31	3.04569	15.65	66	3.14913	3.75	101	4.14432	0.127
32	3.04685	15.20	67	3.15454	3.58	102	4.34126	0.091
33	3.04807	14.75	68	3.16002	3.42	103	4.54568	0.066
34	3.04936	14.30	69	3.16593	3.26	104	4.79803	0.050
35	3.05058	13.90	70	3.17191	3.11			

Table D-6. Lake Shore RX-202A Rox™ Curve

Break-point	logΩ	Temp. (K)	Break-point	logΩ	Temp. (K)	Break-point	logΩ	Temp. (K)
1	3.35085	40.0	34	3.40482	11.45	67	3.52772	2.17
2	3.35222	38.5	35	3.40688	11.00	68	3.53459	2.04
3	3.35346	37.2	36	3.40905	10.55	69	3.54157	1.92
4	3.35476	35.9	37	3.41134	10.10	70	3.54923	1.80
5	3.35612	34.6	38	3.41377	9.65	71	3.55775	1.68
6	3.35755	33.3	39	3.41606	9.25	72	3.56646	1.57
7	3.35894	32.1	40	3.41848	8.85	73	3.57616	1.46
8	3.36039	30.9	41	3.42105	8.45	74	3.58708	1.35
9	3.36192	29.7	42	3.42380	8.05	75	3.59830	1.25
10	3.36340	28.6	43	3.42637	7.70	76	3.61092	1.150
11	3.36495	27.5	44	3.42910	7.35	77	3.62451	1.055
12	3.36659	26.4	45	3.43202	7.00	78	3.63912	0.965
13	3.36831	25.3	46	3.43515	6.65	79	3.65489	0.880
14	3.37014	24.2	47	3.43853	6.30	80	3.67206	0.800
15	3.37191	23.2	48	3.44230	5.94	81	3.69095	0.725
16	3.37377	22.2	49	3.44593	5.62	82	3.71460	0.645
17	3.37575	21.2	50	3.44984	5.30	83	3.73889	0.575
18	3.37785	20.2	51	3.45355	5.02	84	3.76599	0.510
19	3.37942	19.50	52	3.45734	4.76	85	3.79703	0.448
20	3.38081	18.90	53	3.46180	4.48	86	3.83269	0.390
21	3.38226	18.30	54	3.46632	4.22	87	3.87369	0.336
22	3.38377	17.70	55	3.47012	4.02	88	3.92642	0.281
23	3.38522	17.15	56	3.47357	3.85	89	3.98609	0.233
24	3.38672	16.60	57	3.47726	3.68	90	4.05672	0.190
25	3.38829	16.05	58	3.48122	3.51	91	4.14042	0.153
26	3.38993	15.50	59	3.48524	3.35	92	4.24807	0.120
27	3.39165	14.95	60	3.48955	3.19	93	4.40832	0.088
28	3.39345	14.40	61	3.49421	3.03	94	4.57858	0.067
29	3.39516	13.90	62	3.49894	2.88	95	4.76196	0.055
30	3.39695	13.40	63	3.50406	2.73	96	4.79575	0.051
31	3.39882	12.90	64	3.50962	2.58	97	4.81870	0.050
32	3.40079	12.40	65	3.51528	2.44			
33	3.40286	11.90	66	3.52145	2.30			

Table D-7. Type K (Nickel-Chromium vs. Nickel-Aluminum) Thermocouple Curve

Break-point	mV	Temp (K)	Break-point	mV	Temp (K)	Break-point	mV	Temp (K)	Break-point	mV	Temp (K)
1	-6.45774	3.15	48	-6.10828	57.4	95	-2.95792	192	142	18.1482	714.5
2	-6.45733	3.68	49	-6.08343	59.4	96	-2.82629	196	143	19.2959	741.5
3	-6.45688	4.2	50	-6.05645	61.5	97	-2.6762	200.5	144	20.8082	777
4	-6.45632	4.78	51	-6.02997	63.5	98	-2.52392	205	145	23.1752	832.5
5	-6.45565	5.4	52	-6.00271	65.5	99	-2.36961	209.5	146	24.5166	864
6	-6.45494	6	53	-5.97469	67.5	100	-2.21329	214	147	25.6001	889.5
7	-6.4541	6.65	54	-5.94591	69.5	101	-2.05503	218.5	148	26.5536	912
8	-6.4531	7.35	55	-5.91637	71.5	102	-1.87703	223.5	149	27.4199	932.5
9	-6.45201	8.05	56	-5.8861	73.5	103	-1.69672	228.5	150	28.2413	952
10	-6.45073	8.8	57	-5.85508	75.5	104	-1.51427	233.5	151	29.0181	970.5
11	-6.44934	9.55	58	-5.82334	77.5	105	-1.32972	238.5	152	29.7714	988.5
12	-6.44774	10.35	59	-5.78268	80	106	-1.12444	244	153	30.5011	1006
13	-6.44601	11.15	60	-5.74084	82.5	107	-0.91675	249.5	154	31.2074	1023
14	-6.44403	12	61	-5.69792	85	108	-0.70686	255	155	31.8905	1039.5
15	-6.44189	12.85	62	-5.6539	87.5	109	-0.47553	261	156	32.571	1056
16	-6.43947	13.75	63	-5.60879	90	110	-0.22228	267.5	157	33.2489	1072.5
17	-6.43672	14.7	64	-5.5626	92.5	111	0.053112	274.5	158	33.9038	1088.5
18	-6.43378	15.65	65	-5.51535	95	112	0.350783	282	159	34.5561	1104.5
19	-6.43065	16.6	66	-5.46705	97.5	113	0.651006	289.5	160	35.2059	1120.5
20	-6.42714	17.6	67	-5.4177	100	114	0.973714	297.5	161	35.8532	1136.5
21	-6.42321	18.65	68	-5.36731	102.5	115	1.31919	306	162	36.4979	1152.5
22	-6.41905	19.7	69	-5.3159	105	116	1.70801	315.5	163	37.14	1168.5
23	-6.41442	20.8	70	-5.26348	107.5	117	2.14052	326	164	37.7596	1184
24	-6.40952	21.9	71	-5.19928	110.5	118	2.69954	339.5	165	38.3767	1199.5
25	-6.40435	23	72	-5.13359	113.5	119	3.75883	365	166	38.9915	1215
26	-6.39841	24.2	73	-5.06651	116.5	120	4.29687	378	167	39.6038	1230.5
27	-6.39214	25.4	74	-4.99801	119.5	121	4.74986	389	168	40.2136	1246
28	-6.38554	26.6	75	-4.92813	122.5	122	5.17977	399.5	169	40.821	1261.5
29	-6.37863	27.8	76	-4.85687	125.5	123	5.60705	410	170	41.4063	1276.5
30	-6.37077	29.1	77	-4.78426	128.5	124	6.03172	420.5	171	41.9893	1291.5
31	-6.36253	30.4	78	-4.71031	131.5	125	6.49428	432	172	42.5699	1306.5
32	-6.35391	31.7	79	-4.63503	134.5	126	7.09465	447	173	43.1288	1321
33	-6.34422	33.1	80	-4.55845	137.5	127	8.15226	473.5	174	43.6853	1335.5
34	-6.33408	34.5	81	-4.48056	140.5	128	8.75291	488.5	175	44.2394	1350
35	-6.3235	35.9	82	-4.38814	144	129	9.25576	501	176	44.7721	1364
36	-6.3117	37.4	83	-4.29393	147.5	130	9.74087	513	177	45.3024	1378
37	-6.29939	38.9	84	-4.19806	151	131	10.2285	525	178	45.8114	1391.5
38	-6.2866	40.4	85	-4.10051	154.5	132	10.7186	537	179	46.3182	1405
39	-6.27241	42	86	-4.00133	158	133	11.2317	549.5	180	46.8038	1418
40	-6.25768	43.6	87	-3.90053	161.5	134	11.7883	563	181	47.2873	1431
41	-6.24239	45.2	88	-3.79815	165	135	12.3888	577.5	182	47.7684	1444
42	-6.22656	46.8	89	-3.6942	168.5	136	13.054	593.5	183	48.2287	1456.5
43	-6.21019	48.4	90	-3.58873	172	137	13.7844	611	184	48.6868	1469
44	-6.19115	50.2	91	-3.46638	176	138	14.5592	629.5	185	49.1426	1481.5
45	-6.17142	52	92	-3.34204	180	139	15.3786	649	186	49.5779	1493.5
46	-6.15103	53.8	93	-3.21584	184	140	16.2428	669.5	187	50.0111	1505.5
47	-6.12998	55.6	94	-3.08778	188	141	17.1518	691			

Table D-8. Type E (Nickel-Chromium vs. Copper-Nickel) Thermocouple Curve

Break-point	mV	Temp (K)	Break-point	mV	Temp (K)	Break-point	mV	Temp (K)
1	-9.834960	3.15	55	-8.713010	77.50	109	0.701295	285.00
2	-9.834220	3.59	56	-8.646710	80.00	110	1.061410	291.00
3	-9.833370	4.04	57	-8.578890	82.50	111	1.424820	297.00
4	-9.832260	4.56	58	-8.509590	85.00	112	1.791560	303.00
5	-9.830920	5.12	59	-8.438800	87.50	113	2.161610	309.00
6	-9.829330	5.72	60	-8.366570	90.00	114	2.534960	315.00
7	-9.827470	6.35	61	-8.292900	92.50	115	2.943070	321.50
8	-9.825370	7.00	62	-8.217810	95.00	116	3.355100	328.00
9	-9.822890	7.70	63	-8.141330	97.50	117	3.770870	334.50
10	-9.820010	8.45	64	-8.047780	100.50	118	4.190420	341.00
11	-9.816880	9.20	65	-7.952190	103.50	119	4.613650	347.50
12	-9.813290	10.00	66	-7.854690	106.50	120	5.040520	354.00
13	-9.809180	10.85	67	-7.755260	109.50	121	5.470960	360.50
14	-9.804510	11.75	68	-7.653960	112.50	122	5.938380	367.50
15	-9.799510	12.65	69	-7.550790	115.50	123	6.409870	374.50
16	-9.793900	13.60	70	-7.445790	118.50	124	6.885210	381.50
17	-9.787610	14.60	71	-7.338970	121.50	125	7.364360	388.50
18	-9.780590	15.65	72	-7.230370	124.50	126	7.881760	396.00
19	-9.773150	16.70	73	-7.120010	127.50	127	8.403380	403.50
20	-9.764910	17.80	74	-6.989110	131.00	128	8.928940	411.00
21	-9.755820	18.95	75	-6.855790	134.50	129	9.493760	419.00
22	-9.746230	20.10	76	-6.720200	138.00	130	10.0629	427.00
23	-9.735700	21.30	77	-6.582330	141.50	131	10.6361	435.00
24	-9.724650	22.50	78	-6.442220	145.00	132	11.2494	443.50
25	-9.713080	23.70	79	-6.299900	148.50	133	11.867	452.00
26	-9.699960	25.00	80	-6.155400	152.00	134	12.5253	461.00
27	-9.686220	26.30	81	-6.008740	155.50	135	13.188	470.00
28	-9.671890	27.60	82	-5.859960	159.00	136	13.892	479.50
29	-9.655790	29.00	83	-5.687430	163.00	137	14.6005	489.00
30	-9.638980	30.40	84	-5.512090	167.00	138	15.3507	499.00
31	-9.621500	31.80	85	-5.334130	171.00	139	16.1432	509.50
32	-9.602020	33.30	86	-5.153520	175.00	140	16.9403	520.00
33	-9.581740	34.80	87	-4.970330	179.00	141	17.7798	531.00
34	-9.560710	36.30	88	-4.784590	183.00	142	18.6624	542.50
35	-9.537440	37.90	89	-4.596330	187.00	143	19.5881	554.50
36	-9.513290	39.50	90	-4.405600	191.00	144	20.5573	567.00
37	-9.486720	41.20	91	-4.212440	195.00	145	21.5702	580.00
38	-9.457560	43.00	92	-3.992330	199.50	146	22.627	593.50
39	-9.427340	44.80	93	-3.769140	204.00	147	23.7279	607.50
40	-9.396080	46.60	94	-3.543070	208.50	148	24.873	622.00
41	-9.363810	48.40	95	-3.314120	213.00	149	26.0623	637.00
42	-9.330540	50.20	96	-3.082340	217.50	150	27.3356	653.00
43	-9.296270	52.00	97	-2.847790	222.00	151	28.6935	670.00
44	-9.257090	54.00	98	-2.610520	226.50	152	30.1761	688.50
45	-9.216690	56.00	99	-2.343820	231.50	153	31.8242	709.00
46	-9.175140	58.00	100	-2.073770	236.50	154	33.7187	732.50
47	-9.132450	60.00	101	-1.800570	241.50	155	36.1028	762.00
48	-9.088620	62.00	102	-1.524210	246.50	156	41.8502	833.00
49	-9.043710	64.00	103	-1.244740	251.50	157	44.2747	863.00
50	-8.997710	66.00	104	-0.962207	256.50	158	46.2907	888.00
51	-8.950650	68.00	105	-0.676647	261.50	159	48.1007	910.50
52	-8.902530	70.00	106	-0.359204	267.00	160	49.8256	932.00
53	-8.840980	72.50	107	-0.009079	273.00	161	51.5056	953.00
54	-8.777760	75.00	108	0.344505	279.00			

Table D-9. Type T (Copper vs. Copper-Nickel) Thermocouple Curve

Break-point	mV	Temp (K)	Break-point	mV	Temp (K)	Break-point	mV	Temp (K)
1	-6.257510	3.15	56	-5.424100	84.00	111	0.623032	289.00
2	-6.257060	3.56	57	-5.380600	86.50	112	0.843856	294.50
3	-6.256520	4.00	58	-5.336260	89.00	113	1.067190	300.00
4	-6.255810	4.50	59	-5.291080	91.50	114	1.293090	305.50
5	-6.254950	5.04	60	-5.245070	94.00	115	1.521570	311.00
6	-6.253920	5.62	61	-5.188800	97.00	116	1.752660	316.50
7	-6.252780	6.20	62	-5.131290	100.00	117	1.986340	322.00
8	-6.251380	6.85	63	-5.072630	103.00	118	2.222600	327.50
9	-6.249730	7.55	64	-5.012780	106.00	119	2.461410	333.00
10	-6.247810	8.30	65	-4.951770	109.00	120	2.702740	338.50
11	-6.245590	9.10	66	-4.889610	112.00	121	2.946550	344.00
12	-6.243040	9.95	67	-4.826300	115.00	122	3.192800	349.50
13	-6.240300	10.80	68	-4.761840	118.00	123	3.441440	355.00
14	-6.237210	11.70	69	-4.696250	121.00	124	3.715300	361.00
15	-6.233710	12.65	70	-4.629530	124.00	125	3.991980	367.00
16	-6.229800	13.65	71	-4.561670	127.00	126	4.271300	373.00
17	-6.225630	14.65	72	-4.492700	130.00	127	4.553250	379.00
18	-6.221000	15.70	73	-4.422610	133.00	128	4.837770	385.00
19	-6.215860	16.80	74	-4.351390	136.00	129	5.148790	391.50
20	-6.210430	17.90	75	-4.266950	139.50	130	5.462770	398.00
21	-6.204430	19.05	76	-4.180930	143.00	131	5.779560	404.50
22	-6.198680	20.10	77	-4.093440	146.50	132	6.099160	411.00
23	-6.191780	21.30	78	-4.004430	150.00	133	6.421500	417.50
24	-6.184530	22.50	79	-3.913940	153.50	134	6.746540	424.00
25	-6.176930	23.70	80	-3.821970	157.00	135	7.099510	431.00
26	-6.168310	25.00	81	-3.728520	160.50	136	7.455590	438.00
27	-6.159280	26.30	82	-3.633620	164.00	137	7.814630	445.00
28	-6.149830	27.60	83	-3.537260	167.50	138	8.176630	452.00
29	-6.139220	29.00	84	-3.439460	171.00	139	8.541540	459.00
30	-6.128130	30.40	85	-3.340240	174.50	140	8.909320	466.00
31	-6.116580	31.80	86	-3.239610	178.00	141	9.306450	473.50
32	-6.103700	33.30	87	-3.122930	182.00	142	9.706830	481.00
33	-6.090300	34.80	88	-3.004370	186.00	143	10.1103	488.50
34	-6.075460	36.40	89	-2.884040	190.00	144	10.5169	496.00
35	-6.060040	38.00	90	-2.761910	194.00	145	10.9264	503.50
36	-6.044070	39.60	91	-2.638010	198.00	146	11.3664	511.50
37	-6.025470	41.40	92	-2.512340	202.00	147	11.8098	519.50
38	-6.006200	43.20	93	-2.384920	206.00	148	12.2564	527.50
39	-5.986280	45.00	94	-2.255770	210.00	149	12.7342	536.00
40	-5.965730	46.80	95	-2.124900	214.00	150	13.2155	544.50
41	-5.942210	48.80	96	-1.992320	218.00	151	13.7	553.00
42	-5.917930	50.80	97	-1.858060	222.00	152	14.1879	561.50
43	-5.892970	52.80	98	-1.705090	226.50	153	14.7079	570.50
44	-5.864730	55.00	99	-1.549970	231.00	154	15.2314	579.50
45	-5.835680	57.20	100	-1.392820	235.50	155	15.7583	588.50
46	-5.805860	59.40	101	-1.233640	240.00	156	16.2887	597.50
47	-5.776670	61.50	102	-1.072450	244.50	157	16.8224	606.50
48	-5.741100	64.00	103	-0.909257	249.00	158	17.3594	615.50
49	-5.704560	66.50	104	-0.744065	253.50	159	17.9297	625.00
50	-5.667130	69.00	105	-0.576893	258.00	160	18.5037	634.50
51	-5.628800	71.50	106	-0.407776	262.50	161	19.1116	644.50
52	-5.589590	74.00	107	-0.217705	267.50	162	19.7538	655.00
53	-5.549510	76.50	108	-0.025325	272.50	163	20.4611	666.50
54	-5.508560	79.00	109	0.188573	278.00	164	20.8627	673.00
55	-5.466760	81.50	110	0.404639	283.50			

Table D-10. Chromel-AuFe0.03% Thermocouple Curve *

Breakpoint	mV	Temp (K)	Breakpoint	mV	Temp (K)
1	-4.6667	3.5	32	-2.24537	160
2	-4.62838	6.35	33	-2.06041	170
3	-4.60347	8.15	34	-1.86182	180.5
4	-4.58043	9.75	35	-1.66004	191
5	-4.53965	12.5	36	-1.47556	200.5
6	-4.47226	16.95	37	-1.0904	220
7	-4.43743	19.3	38	-0.73397	237.5
8	-4.39529	22.2	39	-0.68333	240
9	-4.34147	26	40	-0.3517	256
10	-4.29859	29.1	41	-0.2385	261.5
11	-4.26887	31.3	42	0.078749	277
12	-4.22608	34.5	43	0.139668	280
13	-4.2018	36.3	44	0.426646	294.5
14	-4.02151	49.8	45	0.546628	300.5
15	-3.94549	55.4	46	0.858608	316
16	-3.87498	60.5	47	0.938667	320
17	-3.80464	65.5	48	1.3456	340
18	-3.73301	70.5	49	1.7279	358.5
19	-3.65274	76	50	1.76905	360.5
20	-3.5937	80	51	2.20705	381.5
21	-3.51113	85.5	52	2.51124	396
22	-3.45023	89.5	53	2.69878	405
23	-3.43451	90.5	54	2.94808	417
24	-3.37842	94	55	3.13562	426
25	-3.35469	95.5	56	3.43707	440.5
26	-3.28237	100	57	3.85513	460.5
27	-3.11919	110	58	4.17136	475.5
28	-2.95269	120	59	4.28662	481
29	-2.78168	130	60	4.64037	498
30	-2.60639	140	61	4.68168	500
31	-2.42737	150			

* This thermocouple is no longer sold by Lake Shore.

Table D-11. Chromel-AuFe0.07% Thermocouple Curve

Break-point	mV	Temp (K)	Break-point	mV	Temp (K)	Break-point	mV	Temp (K)
1	-5.279520	3.15	35	-3.340820	115.00	69	1.313400	332.50
2	-5.272030	3.78	36	-3.253410	119.50	70	1.511140	341.50
3	-5.263500	4.46	37	-3.165360	124.00	71	1.709250	350.50
4	-5.253730	5.20	38	-3.076690	128.50	72	1.928940	360.50
5	-5.242690	6.00	39	-2.977480	133.50	73	2.127070	369.50
6	-5.229730	6.90	40	-2.877550	138.50	74	2.324710	378.50
7	-5.214770	7.90	41	-2.776950	143.50	75	2.523070	387.50
8	-5.196980	9.05	42	-2.675700	148.50	76	2.643480	393.00
9	-5.176250	10.35	43	-2.563610	154.00	77	2.708890	396.00
10	-5.150910	11.90	44	-2.450770	159.50	78	2.764030	398.50
11	-5.116700	13.95	45	-2.337230	165.00	79	2.797580	400.00
12	-5.049770	17.90	46	-2.223010	170.50	80	2.950200	406.50
13	-5.002120	20.70	47	-2.097700	176.50	81	3.008310	409.00
14	-4.938000	24.50	48	-1.971630	182.50	82	3.031200	410.00
15	-4.876180	28.20	49	-1.844890	188.50	83	3.218040	418.00
16	-4.801670	32.70	50	-1.706840	195.00	84	3.300110	421.50
17	-4.648620	42.00	51	-1.568040	201.50	85	4.000810	451.50
18	-4.569170	46.80	52	-1.428520	208.00	86	4.246390	462.00
19	-4.499080	51.00	53	-1.277520	215.00	87	4.701810	481.50
20	-4.435090	54.80	54	-1.114900	222.50	88	4.947390	492.00
21	-4.370520	58.60	55	-0.940599	230.50	89	5.636410	521.50
22	-4.303610	62.50	56	-0.754604	239.00	90	5.870300	531.50
23	-4.234290	66.50	57	-0.556906	248.00	91	6.547630	560.50
24	-4.164270	70.50	58	-0.358437	257.00	92	6.711600	567.50
25	-4.093560	74.50	59	-0.170179	265.50	93	6.781410	570.50
26	-4.022170	78.50	60	0.041150	275.00	94	6.931500	577.00
27	-3.950100	82.50	61	0.152699	280.00	95	7.001360	580.00
28	-3.877360	86.50	62	0.163149	280.50	96	7.166710	587.00
29	-3.803960	90.50	63	0.374937	290.00	97	7.260420	591.00
30	-3.729910	94.50	64	0.542973	297.50	98	7.412010	597.50
31	-3.655230	98.50	65	0.598604	300.00	99	7.529070	602.50
32	-3.579930	102.50	66	0.774384	308.00	100	7.657460	608.00
33	-3.504020	106.50	67	0.840638	311.00	101	7.704410	610.00
34	-3.427530	110.50	68	1.126350	324.00			